





















CARRETOS MÓDULO



industry partners





















INDICE INDEX

DA PAGINA

	PIGNONI PER CATENE A RULLI "SYSTEM BEA" SPROCKETS FOR ROLLER CHAINS "SYSTEM BEA"	6
	PIGNONI PER CATENE A RULLI SPROCKETS FOR ROLLER CHAINS	19
	PIGNONI SEMPLICI TEMPERATI AD INDUZIONE PER CATENE A RULLI SIMPLEX SPROCKETS WITH HARDENED TEETH FOR ROLLER CHAINS	33
	PIGNONI PER BUSSOLA CONICA SPROCKETS FOR TAPER BUSHES	36
	PIGNONI PER BUSSOLA CONICA TEMPERATI AD INDUZIONE SPROCKETS FOR TAPER BUSHES WITH HARDENED TEETH	42
	PIGNONI SEMPLICI PER CATENE A RULLI IN ACCIAIO INOX SIMPLEX SPROCKETS IN STAINLESS STEEL FOR ROLLER CHAINS	44
	PIGNONI GHISA PER CATENE A RULLI CAST IRON SPROCKETS FOR ROLLER CHAINS	46
	PIGNONI PER CATENE A RULLI "ASA" SPROCKETS FOR ROLLER CHAINS "ASA"	50
	CORONE PER CATENE A RULLI PLATE WHEELS FOR ROLLER CHAINS	60
	CORONE DOPPIE PER DUE CATENE SEMPLICI DOUBLE SIMPLE SPROCKETS	75
	PIGNONE TENDICATENA COMPLETO DI CUSCINETTO A SFERE - ELEMENTI DI FISSAGGIO CHAIN-STRETCHER SPROCKETS WITH BALL BEARING - LOCKING PARTS	79
	RUOTE PER CATENE A CERNIERA WHEELS FOR TABLE TOP CHAINS	80
	PIGNONI TENDICATENA CON SFERE E VITE DI FISSAGGIO CHAINS-STRECHER SPROCKETS WITH BALLS AND FASTENING BOLT	80
	RUOTE LIBERE SEMPLICI - RUOTE LIBERE INDUSTRIALI SIMPLEX FREE WHEELS - INDUSTRIAL FREE WHEELS	81
	MOZZI SALDABILI PER BUSSOLA CONICA WELD-ON HUBS FOR TAPER BUSHES	82
	CORONE PER CATENE A RULLI "ASA" PLATE WHEELS FOR ROLLER CHAINS "ASA"	83
	CORONE - PIGNONI PER CATENE TRASPORTO PLATE WHEELS - SPROCKETS FOR CONVEYOR CHAINS	93
	CATENE A RULLI "BEA" ROLLER CHAINS "BEA"	100
	CATENE A RULLI "SATURN" ROLLER CHAINS "SATURN"	116
	GUIDACATENE CHAIN GUIDE RAILS	119
	TENDICATENA - ELEMENTI ELASTICI CHAIN TENSIONERS - RUBBER SUSPENSION UNIT	124

INDICE INDEX

DA PAGINA

	RUOTE DENTATE CILINDRICHE CYLINDRICAL GEARS	136
	CREMAGLIERE RACKS	144
	RUOTE DENTATE CONICHE DENTI DIRITTI TIPO - A - B CONICAL STRAIGHT TOOTHED GEARS TYPE - A - B	145
	RUOTE DENTATE CONICHE DENTI SPIROIDALI CONICAL SPIRAL TOOTHED GEARS	151
	PULEGGE DENTATE PER CINGHIE POSITIVE SYNCHROBELT® TIMING BELT PULLEYS	156
	PULEGGE DENTATE A BUSSOLA CONICA PER CINGHIE POSITIVE SYNCHROBELT® TIMING BELT PULLEYS FOR TAPER BUSHES	168
	PULEGGE DENTATE PER CINGHIE SYNCHROBELT® "HTD" SYNCHROBELT® "HTD" TIMING BELT PULLEYS	175
	PULEGGE DENTATE A BUSSOLA CONICA PER CINGHIE SYNCHROBELT® "HTD" SYNCHROBELT® "HTD" TIMING BELT PULLEYS FOR TAPER BUSHES	189
	PULEGGE DENTATE PASSO METRICO METRIC PULLEYS	199
	BARRE PER CINGHIE DENTATE TIMING BELT BARS	214
	FLANGE ZINCATE PER PULEGGE DENTATE ZINC PLATED FLANGES FOR PULLEYS	218
	CINGHIE DENTATE - MANICOTTI DENTATI TIMING BELTS - SLEEVES	223
	CINGHIE DENTATE A METRAGGIO LONG - LENGTH BELTING	245
	PIASTRE DI BLOCCAGGIO PER CINGHIE DENTATE CLAMPING BELT PLATES	246
	PULEGGE A GOLE TRAPEZOIDALI PER BUSSOLA CONICA V-BELT PULLEYS FOR TAPER BUSHES	248
	CINGHIE TRAPEZOIDALI V-BELTS	279
	BUSSOLE CONICHE DI SERRAGGIO TAPER BUSHES	301
	CALETTATORI LOCKING ASSEMBLIES	308
	SLITTE TENDICINGHIA PER MOTORI ELETTRICI ADJUSTABLE MOTOR MOUNTING	325
	GIUNTI DENTATI "GFB" GEARS COUPLINGS "GFB"	328

PIGNONI PER CATENE A RULLI "SYSTEM BEA" - DIN 8187 - ISO 606

SPROCKETS FOR ROLLER CHAINS "SYSTEM BEA" - DIN 8187 - ISO 606

3/8" x 7/32"

9,525 x 5,72 mm

**Rullo 6,35 mm
06B-1**

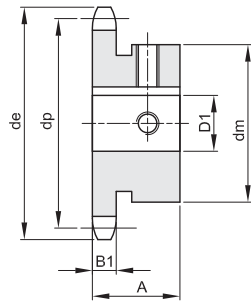
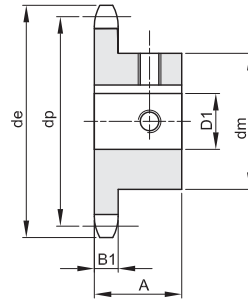
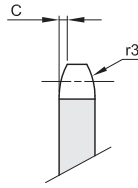

B1	C	r3
----	---	----

5,3	1	10
-----	---	----

Materiale acciaio C45 - TIPO ^ eseguiti con cava e un foro a 90°

TIPO *

Z	de	dp	dm	D1	A	Kg.
10	34,5	30,82	24*	10^	20	0,06
10	34,5	30,82	26*	12	20	0,07
10	34,5	30,82	29*	14	20	0,07
11	37,5	33,80	24*	10^	25	0,09
11	37,5	33,80	26*	12	25	0,09
11	37,5	33,80	29*	14	25	0,10
11	37,5	33,80	30*	15	25	0,10
11	37,5	33,80	31*	16	25	0,11
12	40,5	36,80	25	10^	25	0,10
12	40,5	36,80	26*	12	25	0,10
12	40,5	36,80	29*	14	25	0,11
12	40,5	36,80	30*	15	25	0,11
12	40,5	36,80	31*	16	25	0,11
13	43,5	39,80	28	10^	25	0,13
13	43,5	39,80	28	12	25	0,12
13	43,5	39,80	28	14	25	0,11
13	43,5	39,80	28	15	25	0,11
13	43,5	39,80	31*	16	25	0,12
13	43,5	39,80	34*	18	25	0,13
14	46,5	42,80	31	10^	25	0,16
14	46,5	42,80	31	12	25	0,15
14	46,5	42,80	31	14	25	0,17
14	46,5	42,80	31	15	25	0,14
14	46,5	42,80	31	16	25	0,13
14	46,5	42,80	31	18	25	0,12
14	46,5	42,80	35*	19	25	0,14
15	49,5	45,81	34	12	25	0,18
15	49,5	45,81	34	14	25	0,18
15	49,5	45,81	34	15	25	0,17
15	49,5	45,81	34	16	25	0,17
15	49,5	45,81	34	18	25	0,15
15	49,5	45,81	34	19	25	0,15
15	49,5	45,81	34	20	25	0,14
15	49,5	45,81	42*	22	25	0,19
15	49,5	45,81	42*	24	25	0,17
15	49,5	45,81	42*	25	25	0,16
16	52,5	48,82	37	12	28	0,24
16	52,5	48,82	37	14	28	0,23
16	52,5	48,82	37	15	28	0,23
16	52,5	48,82	37	16	28	0,22
16	52,5	48,82	37	18	28	0,21
16	52,5	48,82	37	19	28	0,20
16	52,5	48,82	37	20	28	0,20

Z	de	dp	dm	D1	A	Kg.
16	52,5	48,82	37	22	28	0,18
16	52,5	48,82	42*	24	28	0,21
16	52,5	48,82	42*	25	28	0,20
17	55,5	51,83	40	12	28	0,28
17	55,5	51,83	40	14	28	0,28
17	55,5	51,83	40	15	28	0,27
17	55,5	51,83	40	16	28	0,26
17	55,5	51,83	40	18	28	0,25
17	55,5	51,83	40	19	28	0,24
17	55,5	51,83	40	20	28	0,24
17	55,5	51,83	40	22	28	0,23
17	55,5	51,83	40	24	28	0,26
17	55,5	51,83	40	25	28	0,26
18	58,6	54,85	40	12	28	0,30
18	58,6	54,85	40	14	28	0,28
18	58,6	54,85	43	15	28	0,31
18	58,6	54,85	43	16	28	0,31
18	58,6	54,85	43	18	28	0,29
18	58,6	54,85	43	19	28	0,29
18	58,6	54,85	43	20	28	0,28
18	58,6	54,85	43	22	28	0,27
18	58,6	54,85	43	24	28	0,25
18	58,6	54,85	43	25	28	0,24
19	61,6	57,87	40	12	28	0,31
19	61,6	57,87	40	14	28	0,30
19	61,6	57,87	45	15	28	0,35
19	61,6	57,87	45	16	28	0,35
19	61,6	57,87	45	18	28	0,33
19	61,6	57,87	45	19	28	0,33
19	61,6	57,87	45	20	28	0,32
19	61,6	57,87	45	22	28	0,31
19	61,6	57,87	45	24	28	0,29
19	61,6	57,87	45	25	28	0,28
20	64,6	60,89	40	12	28	0,32
20	64,6	60,89	40	14	28	0,31
20	64,6	60,89	46	15	28	0,38
20	64,6	60,89	46	16	28	0,37
20	64,6	60,89	46	18	28	0,36
20	64,6	60,89	46	19	28	0,35
20	64,6	60,89	46	20	28	0,34
20	64,6	60,89	46	22	28	0,33
20	64,6	60,89	46	24	28	0,31
20	64,6	60,89	46	25	28	0,30

PIGNONI PER CATENE A RULLI "SYSTEM BEA" - DIN 8187 - ISO 606 SPROCKETS FOR ROLLER CHAINS "SYSTEM BEA" - DIN 8187 - ISO 606

3/8" x 7/32"

9,525 x 5,72 mm

Rullo 6,35 mm

06B-1

B1	C	r3
5,3	1	10

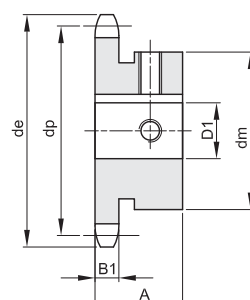
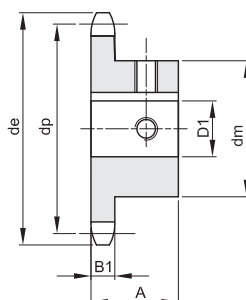
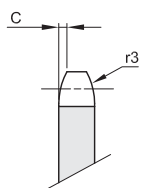

Materiale acciaio C45 - TIPO ^ eseguiti con cava e un foro a 90°

TIPO *

Z	de	dp	dm	D1	A	Kg.
21	67,6	63,91	48	15	28	0,41
21	67,6	63,91	48	16	28	0,40
21	67,6	63,91	48	18	28	0,39
21	67,6	63,91	48	19	28	0,39
21	67,6	63,91	48	20	28	0,38
21	67,6	63,91	48	22	28	0,37
21	67,6	63,91	48	24	28	0,35
21	67,6	63,91	48	25	28	0,34
22	70,6	66,93	50	15	28	0,45
22	70,6	66,93	50	16	28	0,45
22	70,6	66,93	50	18	28	0,43
22	70,6	66,93	50	19	28	0,43
22	70,6	66,93	50	20	28	0,42
22	70,6	66,93	50	22	28	0,41
22	70,6	66,93	50	24	28	0,39
22	70,6	66,93	50	25	28	0,38
23	73,7	69,95	52	15	28	0,49
23	73,7	69,95	52	16	28	0,49
23	73,7	69,95	52	18	28	0,48
23	73,7	69,95	52	19	28	0,47
23	73,7	69,95	52	20	28	0,46
23	73,7	69,95	52	22	28	0,45
23	73,7	69,95	52	24	28	0,43
23	73,7	69,95	52	25	28	0,42
24	76,7	72,97	50	16	28	0,47
24	76,7	72,97	50	18	28	0,46
24	76,7	72,97	54	19	28	0,51
24	76,7	72,97	54	20	28	0,51
24	76,7	72,97	54	22	28	0,49
24	76,7	72,97	54	24	28	0,47
24	76,7	72,97	54	25	28	0,47
24	76,7	72,97	54	28	28	0,44
24	76,7	72,97	54	30	28	0,42
25	79,7	76,00	50	16	28	0,49
25	79,7	76,00	50	18	28	0,48
25	79,7	76,00	50	19	28	0,47
25	79,7	76,00	57	20	28	0,57
25	79,7	76,00	57	22	28	0,55
25	79,7	76,00	57	24	28	0,53
25	79,7	76,00	57	25	28	0,52
25	79,7	76,00	57	28	28	0,50
25	79,7	76,00	57	30	28	0,48
30	94,8	91,12	60	20	30	0,74

Z	de	dp	dm	D1	A	Kg.
30	94,8	91,12	60	22	30	0,73
30	94,8	91,12	60	24	30	0,71
30	94,8	91,12	60	25	30	0,70
30	94,8	91,12	60	28	30	0,67
30	94,8	91,12	60	30	30	0,66

PIGNONI PER CATENE A RULLI "SYSTEM BEA" - DIN 8187 - ISO 606

SPROCKETS FOR ROLLER CHAINS "SYSTEM BEA" - DIN 8187 - ISO 606

1/2" x 5/16"
12,7 x 7,75 mm
Rullo 8,51 mm
08B-1

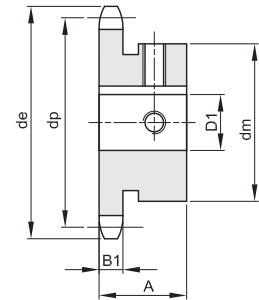
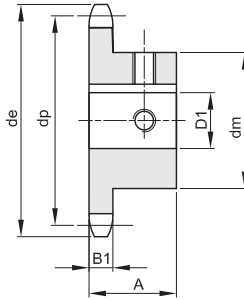
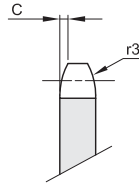

TIPO *

B1	C	r3
7,2	1,3	13

Materiale acciaio C45

Z	de	dp	dm	D1	A	Kg.
10	45,9	41,10	26	12	25	0,12
10	45,9	41,10	26	14	25	0,11
10	45,9	41,10	31*	15	25	0,12
10	45,9	41,10	31*	16	25	0,12
11	49,9	45,07	29	12	25	0,15
11	49,9	45,07	29	14	25	0,14
11	49,9	45,07	31*	15	25	0,14
11	49,9	45,07	31*	16	25	0,14
11	49,9	45,07	37*	18	25	0,16
11	49,9	45,07	37*	19	25	0,16
12	53,9	49,07	33	12	28	0,21
12	53,9	49,07	33	14	28	0,20
12	53,9	49,07	33	15	28	0,19
12	53,9	49,07	33	16	28	0,19
12	53,9	49,07	33	18	28	0,18
12	53,9	49,07	33	19	28	0,17
12	53,9	49,07	33	20	28	0,17
12	53,9	49,07	40*	22	28	0,20
12	53,9	49,07	41*	24	28	0,19
12	53,9	49,07	42*	25	28	0,19
13	57,9	56,06	37	12	28	0,27
13	57,9	56,06	37	14	28	0,26
13	57,9	56,06	37	15	28	0,26
13	57,9	56,06	37	16	28	0,25
13	57,9	56,06	37	18	28	0,24
13	57,9	56,06	37	19	28	0,23
13	57,9	56,06	37	20	28	0,22
13	57,9	56,06	37	22	28	0,21
13	57,9	56,06	42*	24	28	0,22
13	57,9	56,06	42*	25	28	0,21
13	57,9	56,06	45*	28	28	0,21
14	61,9	57,07	33	12	28	0,32
14	61,9	57,07	33	14	28	0,31
14	61,9	57,07	41	15	28	0,31
14	61,9	57,07	41	16	28	0,30
14	61,9	57,07	41	18	28	0,29
14	61,9	57,07	41	19	28	0,28
14	61,9	57,07	41	20	28	0,28
14	61,9	57,07	41	22	28	0,27
14	61,9	57,07	41	24	28	0,25
14	61,9	57,07	41	25	28	0,24
14	61,9	57,07	48*	28	28	0,27
15	65,9	61,09	33	12	28	0,37
15	65,9	61,09	33	14	28	0,36
15	65,9	61,09	45	15	28	0,37

Z	de	dp	dm	D1	A	Kg.
15	65,9	61,09	45	16	28	0,37
15	65,9	61,09	45	18	28	0,36
15	65,9	61,09	45	19	28	0,35
15	65,9	61,09	45	20	28	0,34
15	65,9	61,09	45	22	28	0,32
15	65,9	61,09	45	24	28	0,31
15	65,9	61,09	45	25	28	0,30
15	65,9	61,09	45	28	28	0,27
15	65,9	61,09	52*	30	28	0,32
15	65,9	61,09	52*	32	28	0,30
16	69,9	65,10	50	15	28	0,47
16	69,9	65,10	50	16	28	0,46
16	69,9	65,10	50	18	28	0,44
16	69,9	65,10	50	19	28	0,43
16	69,9	65,10	50	20	28	0,43
16	69,9	65,10	50	22	28	0,40
16	69,9	65,10	50	24	28	0,39
16	69,9	65,10	50	25	28	0,38
16	69,9	65,10	50	28	28	0,35
16	69,9	65,10	50	30	28	0,34
16	69,9	65,10	57*	32	28	0,40
17	74,0	69,11	52	15	28	0,51
17	74,0	69,11	52	16	28	0,51
17	74,0	69,11	52	18	28	0,49
17	74,0	69,11	52	19	28	0,48
17	74,0	69,11	52	20	28	0,47
17	74,0	69,11	52	22	28	0,45
17	74,0	69,11	52	24	28	0,44
17	74,0	69,11	52	25	28	0,43
17	74,0	69,11	52	28	28	0,40
17	74,0	69,11	52	30	28	0,39
17	74,0	69,11	52	32	28	0,38
18	78,0	73,14	52	16	28	0,53
18	78,0	73,14	52	18	28	0,51
18	78,0	73,14	52	19	28	0,50
18	78,0	73,14	56	20	28	0,55
18	78,0	73,14	56	22	28	0,53
18	78,0	73,14	56	24	28	0,52
18	78,0	73,14	56	25	28	0,51
18	78,0	73,14	56	28	28	0,48
18	78,0	73,14	56	30	28	0,46
18	78,0	73,14	56	32	28	0,43
18	78,0	73,14	56	35	28	0,41
18	78,0	73,14	56	38	28	0,39
19	82,0	77,16	52	16	28	0,55

PIGNONI PER CATENE A RULLI "SYSTEM BEA" - DIN 8187 - ISO 606

SPROCKETS FOR ROLLER CHAINS "SYSTEM BEA" - DIN 8187 - ISO 606

1/2" x 5/16"
12,7 x 7,75 mm
Rullo 8,51 mm
08B-1

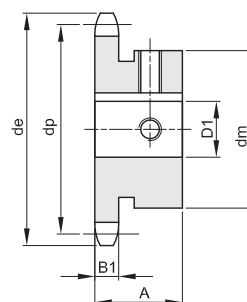
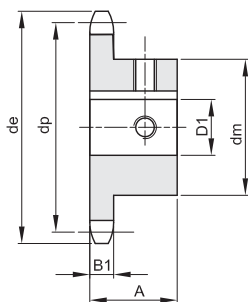
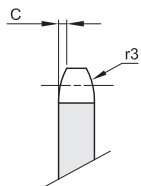

TIPO *

B1	C	r3
7,2	1,3	13

Materiale acciaio C45

Z	de	dp	dm	D1	A	Kg.
19	82,0	77,16	52	18	28	0,53
19	82,0	77,16	52	19	28	0,52
19	82,0	77,16	60	20	28	0,64
19	82,0	77,16	60	22	28	0,62
19	82,0	77,16	60	24	28	0,60
19	82,0	77,16	60	25	28	0,59
19	82,0	77,16	60	28	28	0,57
19	82,0	77,16	60	30	28	0,55
19	82,0	77,16	60	32	28	0,53
19	82,0	77,16	60	35	28	0,49
19	82,0	77,16	60	38	28	0,46
20	86,0	81,19	55	16	28	0,64
20	86,0	81,19	55	18	28	0,61
20	86,0	81,19	55	19	28	0,59
20	86,0	81,19	64	20	28	0,74
20	86,0	81,19	64	22	28	0,72
20	86,0	81,19	64	24	28	0,71
20	86,0	81,19	64	25	28	0,70
20	86,0	81,19	64	28	28	0,67
20	86,0	81,19	64	30	28	0,65
20	86,0	81,19	64	32	28	0,63
20	86,0	81,19	64	35	28	0,61
20	86,0	81,19	64	38	28	0,59
21	90,1	85,22	55	16	28	0,74
21	90,1	85,22	55	18	28	0,72
21	90,1	85,22	55	19	28	0,71
21	90,1	85,22	60	20	28	0,70
21	90,1	85,22	60	22	28	0,68
21	90,1	85,22	68	24	28	0,80
21	90,1	85,22	68	25	28	0,79
21	90,1	85,22	68	28	28	0,77
21	90,1	85,22	68	30	28	0,75
21	90,1	85,22	68	32	28	0,72
21	90,1	85,22	68	35	28	0,69
21	90,1	85,22	68	38	28	0,65
22	94,1	89,24	55	16	28	0,84
22	94,1	89,24	55	18	28	0,81
22	94,1	89,24	55	19	28	0,80
22	94,1	89,24	65	20	28	0,82
22	94,1	89,24	65	22	28	0,80
22	94,1	89,24	70	24	28	0,87
22	94,1	89,24	70	25	28	0,86
22	94,1	89,24	70	28	28	0,83
22	94,1	89,24	70	30	28	0,81
22	94,1	89,24	70	32	28	0,78

Z	de	dp	dm	D1	A	Kg.
22	94,1	89,24	70	35	28	0,75
22	94,1	89,24	70	38	28	0,71
23	98,1	93,27	65	19	28	0,86
23	98,1	93,27	65	20	28	0,85
23	98,1	93,27	70	22	28	0,93
23	98,1	93,27	70	24	28	0,90
23	98,1	93,27	70	25	28	0,89
23	98,1	93,27	70	28	28	0,86
23	98,1	93,27	70	30	28	0,84
23	98,1	93,27	70	32	28	0,82
23	98,1	93,27	70	35	28	0,79
23	98,1	93,27	70	38	28	0,76
24	102,1	97,29	65	19	28	0,91
24	102,1	97,29	65	20	28	0,89
24	102,1	97,29	70	22	28	0,92
24	102,1	97,29	70	24	28	0,94
24	102,1	97,29	70	25	28	0,93
24	102,1	97,29	70	28	28	0,90
24	102,1	97,29	70	30	28	0,88
24	102,1	97,29	70	32	28	0,85
24	102,1	97,29	70	35	28	0,82
24	102,1	97,29	70	38	28	0,79
25	106,2	101,33	65	19	28	0,94
25	106,2	101,33	65	20	28	0,92
25	106,2	101,33	70	22	28	0,99
25	106,2	101,33	70	24	28	0,97
25	106,2	101,33	70	25	28	0,97
25	106,2	101,33	70	28	28	0,94
25	106,2	101,33	70	30	28	0,92
25	106,2	101,33	70	32	28	0,90
25	106,2	101,33	70	35	28	0,86
25	106,2	101,33	70	38	28	0,80
30	126,3	121,50	75	25	30	1,31
30	126,3	121,50	75	28	30	1,28
30	126,3	121,50	80	30	30	1,37
30	126,3	121,50	80	32	30	1,34
30	126,3	121,50	80	35	30	1,31
30	126,3	121,50	80	38	30	1,28

PIGNONI PER CATENE A RULLI "SYSTEM BEA" - DIN 8187 - ISO 606

SPROCKETS FOR ROLLER CHAINS "SYSTEM BEA" - DIN 8187 - ISO 606

5/8" x 3/8"

15,875 x 9,65 mm
Rullo 10,16 mm
10B-1

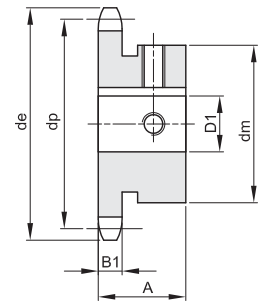
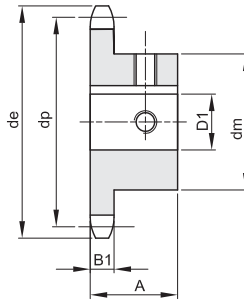
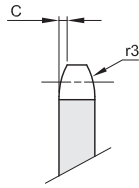

TIPO *

B1	C	r3
9,1	1,6	16

Materiale acciaio C45

Z	de	dp	dm	D1	A	Kg.
10	58,3	51,37	35	15	25	0,21
10	58,3	51,37	35	16	25	0,21
10	58,3	51,37	35	18	25	0,20
10	58,3	51,37	35	19	25	0,20
10	58,3	51,37	35	20	25	0,18
10	58,3	51,37	35	20	25	0,21
11	63,2	56,34	37	15	30	0,30
11	63,2	56,34	37	16	30	0,30
11	63,2	56,34	37	18	30	0,28
11	63,2	56,34	37	19	30	0,27
11	63,2	56,34	37	20	30	0,26
11	63,2	56,34	37	20	30	0,30
11	63,2	56,34	37	24	30	0,30
11	63,2	56,34	37	25	30	0,29
11	63,2	56,34	37	28	30	0,27
12	68,2	61,34	42	15	30	0,38
12	68,2	61,34	42	16	30	0,37
12	68,2	61,34	42	18	30	0,35
12	68,2	61,34	42	19	30	0,34
12	68,2	61,34	42	20	30	0,34
12	68,2	61,34	42	22	30	0,33
12	68,2	61,34	42	24	30	0,31
12	68,2	61,34	42	25	30	0,30
12	68,2	61,34	42	28	30	0,34
12	68,2	61,34	42	30	30	0,32
12	68,2	61,34	42	32	30	0,34
13	73,2	66,32	47	15	30	0,48
13	73,2	66,32	47	16	30	0,47
13	73,2	66,32	47	18	30	0,45
13	73,2	66,32	47	19	30	0,44
13	73,2	66,32	47	20	30	0,44
13	73,2	66,32	47	22	30	0,42
13	73,2	66,32	47	24	30	0,40
13	73,2	66,32	47	25	30	0,39
13	73,2	66,32	47	28	30	0,36
13	73,2	66,32	47	30	30	0,34
13	73,2	66,32	47	32	30	0,40
14	78,2	71,34	52	15	30	0,57
14	78,2	71,34	52	16	30	0,56
14	78,2	71,34	52	18	30	0,54
14	78,2	71,34	52	19	30	0,54
14	78,2	71,34	52	20	30	0,53
14	78,2	71,34	52	22	30	0,51
14	78,2	71,34	52	24	30	0,50

Z	de	dp	dm	D1	A	Kg.
14	78,2	71,34	52	25	30	0,49
14	78,2	71,34	52	28	30	0,46
14	78,2	71,34	52	30	30	0,44
14	78,2	71,34	52	32	30	0,42
15	83,2	76,36	57	19	30	0,67
15	83,2	76,36	57	20	30	0,65
15	83,2	76,36	57	22	30	0,63
15	83,2	76,36	57	24	30	0,61
15	83,2	76,36	57	25	30	0,60
15	83,2	76,36	57	28	30	0,57
15	83,2	76,36	57	30	30	0,55
15	83,2	76,36	57	32	30	0,52
15	83,2	76,36	57	35	30	0,49
16	88,3	81,37	60	19	30	0,76
16	88,3	81,37	60	20	30	0,74
16	88,3	81,37	60	22	30	0,73
16	88,3	81,37	60	24	30	0,71
16	88,3	81,37	60	25	30	0,70
16	88,3	81,37	60	28	30	0,68
16	88,3	81,37	60	30	30	0,65
16	88,3	81,37	60	32	30	0,62
16	88,3	81,37	60	35	30	0,58
16	88,3	81,37	60	38	30	0,54
17	93,3	86,39	60	19	30	0,80
17	93,3	86,39	60	20	30	0,78
17	93,3	86,39	60	22	30	0,76
17	93,3	86,39	60	24	30	0,75
17	93,3	86,39	60	25	30	0,74
17	93,3	86,39	60	28	30	0,71
17	93,3	86,39	60	30	30	0,69
17	93,3	86,39	60	32	30	0,65
17	93,3	86,39	60	35	30	0,63
17	93,3	86,39	60	38	30	0,60
18	98,3	91,42	60	19	30	0,85
18	98,3	91,42	60	20	30	0,83
18	98,3	91,42	70	22	30	0,97
18	98,3	91,42	70	24	30	0,96
18	98,3	91,42	70	25	30	0,95
18	98,3	91,42	70	28	30	0,93
18	98,3	91,42	70	30	30	0,91
18	98,3	91,42	70	32	30	0,87
18	98,3	91,42	70	35	30	0,84
18	98,3	91,42	70	38	30	0,80

PIGNONI PER CATENE A RULLI "SYSTEM BEA" - DIN 8187 - ISO 606

SPROCKETS FOR ROLLER CHAINS "SYSTEM BEA" - DIN 8187 - ISO 606

5/8" x 3/8"

15,875 x 9,65 mm
Rullo 10,16 mm
10B-1

B1	C	r3
9,1	1,6	16

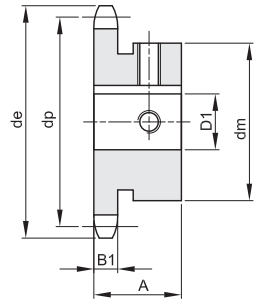
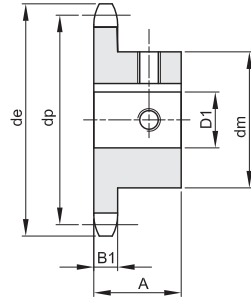
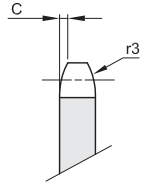

TIPO *

Materiale acciaio C45

Z	de	dp	dm	D1	A	Kg.
18	98,3	91,42	70	40	30	0,77
18	98,3	91,42	70	42	30	0,74
19	103,3	96,45	60	19	30	0,91
19	103,3	96,45	60	20	30	0,90
19	103,3	96,45	70	22	30	1,07
19	103,3	96,45	70	24	30	1,02
19	103,3	96,45	70	25	30	1,02
19	103,3	96,45	70	28	30	1,00
19	103,3	96,45	70	30	30	0,97
19	103,3	96,45	70	32	30	0,94
19	103,3	96,45	70	35	30	0,91
19	103,3	96,45	70	38	30	0,86
19	103,3	96,45	70	40	30	0,83
19	103,3	96,45	70	42	30	0,80
20	108,4	101,49	65	19	30	1,06
20	108,4	101,49	65	20	30	1,04
20	108,4	101,49	65	22	30	1,01
20	108,4	101,49	70	24	30	1,08
20	108,4	101,49	70	25	30	1,07
20	108,4	101,49	75	28	30	1,13
20	108,4	101,49	75	30	30	1,11
20	108,4	101,49	75	32	30	1,08
20	108,4	101,49	75	35	30	1,05
20	108,4	101,49	75	38	30	1,01
20	108,4	101,49	75	40	30	0,98
20	108,4	101,49	75	42	30	0,95
21	113,4	106,52	65	19	30	1,10
21	113,4	106,52	65	20	30	1,08
21	113,4	106,52	65	22	30	1,06
21	113,4	106,52	70	24	30	1,13
21	113,4	106,52	70	25	30	1,12
21	113,4	106,52	75	28	30	1,15
21	113,4	106,52	75	30	30	1,17
21	113,4	106,52	75	32	30	1,14
21	113,4	106,52	75	35	30	1,11
21	113,4	106,52	75	38	30	1,08
21	113,4	106,52	75	40	30	1,03
21	113,4	106,52	75	42	30	0,99
22	118,4	111,55	65	19	30	1,16
22	118,4	111,55	65	20	30	1,14
22	118,4	111,55	65	22	30	1,11
22	118,4	111,55	70	24	30	1,20
22	118,4	111,55	70	25	30	1,19

Z	de	dp	dm	D1	A	Kg.
22	118,4	111,55	80	28	30	1,35
22	118,4	111,55	80	30	30	1,32
22	118,4	111,55	80	32	30	1,29
22	118,4	111,55	80	35	30	1,26
22	118,4	111,55	80	38	30	1,23
22	118,4	111,55	80	40	30	1,19
22	118,4	111,55	80	42	30	1,17
23	123,5	116,58	65	19	30	1,25
23	123,5	116,58	65	20	30	1,22
23	123,5	116,58	65	22	30	1,20
23	123,5	116,58	70	24	30	1,27
23	123,5	116,58	70	25	30	1,25
23	123,5	116,58	80	28	30	1,36
23	123,5	116,58	80	30	30	1,39
23	123,5	116,58	80	32	30	1,36
23	123,5	116,58	80	35	30	1,33
23	123,5	116,58	80	38	30	1,30
23	123,5	116,58	80	40	30	1,26
23	123,5	116,58	80	42	30	1,20
24	128,5	121,62	65	19	30	1,30
24	128,5	121,62	65	20	30	1,28
24	128,5	121,62	65	22	30	1,25
24	128,5	121,62	70	24	30	1,34
24	128,5	121,62	70	25	30	1,33
24	128,5	121,62	80	28	30	1,48
24	128,5	121,62	80	30	30	1,45
24	128,5	121,62	80	32	30	1,42
24	128,5	121,62	80	35	30	1,40
24	128,5	121,62	80	38	30	1,35
24	128,5	121,62	80	40	30	1,33
24	128,5	121,62	80	42	30	1,30
25	133,6	126,66	65	19	30	1,37
25	133,6	126,66	65	20	30	1,35
25	133,6	126,66	65	22	30	1,32
25	133,6	126,66	70	24	30	1,41
25	133,6	126,66	70	25	30	1,39
25	133,6	126,66	80	28	30	1,56
25	133,6	126,66	80	30	30	1,53
25	133,6	126,66	80	32	30	1,50
25	133,6	126,66	80	35	30	1,47
25	133,6	126,66	80	38	30	1,43
25	133,6	126,66	80	40	30	1,40
25	133,6	126,66	80	42	30	1,38

PIGNONI PER CATENE A RULLI "SYSTEM BEA" - DIN 8187 - ISO 606

SPROCKETS FOR ROLLER CHAINS "SYSTEM BEA" - DIN 8187 - ISO 606

3/4" x 7/16"

19,05 x 11,68 mm
Rullo 12,07 mm
12B-1

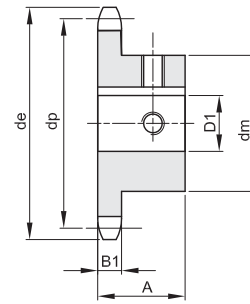
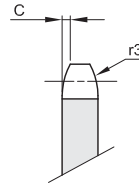

B1	C	r3
11,1	2	19

Materiale acciaio C45

Z	de	dp	dm	D1	A	Kg.	Z	de	dp	dm	D1	A	Kg.
10	69,8	61,64	42	19	30	0,37	15	99,8	91,63	70	28	35	1,09
10	69,8	61,64	42	20	30	0,36	15	99,8	91,63	70	30	35	1,06
10	69,8	61,64	42	24	30	0,33	15	99,8	91,63	70	32	35	1,03
10	69,8	61,64	42	25	30	0,32	15	99,8	91,63	70	35	35	0,99
11	75,8	67,61	46	19	35	0,51	15	99,8	91,63	70	38	35	0,95
11	75,8	67,61	46	20	35	0,50	15	99,8	91,63	70	40	35	0,91
11	75,8	67,61	46	24	35	0,46	16	105,8	97,65	65	19	35	1,17
11	75,8	67,61	46	25	35	0,45	16	105,8	97,65	65	20	35	1,15
12	81,8	73,60	52	19	35	0,67	16	105,8	97,65	65	22	35	1,12
12	81,8	73,60	52	20	35	0,66	16	105,8	97,65	70	24	35	1,22
12	81,8	73,60	52	22	35	0,64	16	105,8	97,65	70	25	35	1,20
12	81,8	73,60	52	24	35	0,61	16	105,8	97,65	75	28	35	1,30
12	81,8	73,60	52	25	35	0,60	16	105,8	97,65	75	30	35	1,25
12	81,8	73,60	52	28	35	0,57	16	105,8	97,65	75	32	35	1,20
12	81,8	73,60	52	30	35	0,55	16	105,8	97,65	75	35	35	1,16
12	81,8	73,60	56	32	35	0,59	16	105,8	97,65	75	38	35	1,12
12	81,8	73,60	56	35	35	0,54	16	105,8	97,65	75	40	35	1,08
13	87,8	79,59	58	19	35	0,82	17	111,9	103,67	70	25	35	1,28
13	87,8	79,59	58	20	35	0,81	17	111,9	103,67	80	28	35	1,35
13	87,8	79,59	58	22	35	0,80	17	111,9	103,67	80	30	35	1,43
13	87,8	79,59	58	24	35	0,77	17	111,9	103,67	80	32	35	1,40
13	87,8	79,59	58	25	35	0,76	17	111,9	103,67	80	35	35	1,37
13	87,8	79,59	58	28	35	0,73	17	111,9	103,67	80	38	35	1,33
13	87,8	79,59	58	30	35	0,70	17	111,9	103,67	80	40	35	1,28
13	87,8	79,59	58	32	35	0,66	17	111,9	103,67	80	42	35	1,23
13	87,8	79,59	58	35	35	0,62	18	117,9	109,71	70	25	35	1,37
13	87,8	79,59	61	38	35	0,67	18	117,9	109,71	80	28	35	1,55
14	93,8	85,61	60	19	35	0,92	18	117,9	109,71	80	30	35	1,52
14	93,8	85,61	60	20	35	0,91	18	117,9	109,71	80	32	35	1,49
14	93,8	85,61	60	22	35	0,88	18	117,9	109,71	80	35	35	1,45
14	93,8	85,61	64	24	35	0,94	18	117,9	109,71	80	38	35	1,40
14	93,8	85,61	64	25	35	0,93	18	117,9	109,71	80	40	35	1,36
14	93,8	85,61	64	28	35	0,90	18	117,9	109,71	80	42	35	1,32
14	93,8	85,61	64	30	35	0,87	19	123,9	115,75	70	25	35	1,45
14	93,8	85,61	64	32	35	0,84	19	123,9	115,75	80	28	35	1,65
14	93,8	85,61	64	35	35	0,80	19	123,9	115,75	80	30	35	1,62
14	93,8	85,61	64	38	35	0,75	19	123,9	115,75	80	32	35	1,57
14	93,8	85,61	67	40	35	0,85	19	123,9	115,75	80	35	35	1,53
15	99,8	91,63	65	19	35	1,10	19	123,9	115,75	80	38	35	1,49
15	99,8	91,63	65	20	35	1,08	19	123,9	115,75	80	40	35	1,46
15	99,8	91,63	65	22	35	1,03	19	123,9	115,75	80	42	35	1,42
15	99,8	91,63	70	24	35	1,13	19	123,9	115,75	80	45	35	1,37
15	99,8	91,63	70	25	35	1,11	19	123,9	115,75	80	48	35	1,32

PIGNONI PER CATENE A RULLI "SYSTEM BEA" - DIN 8187 - ISO 606

SPROCKETS FOR ROLLER CHAINS "SYSTEM BEA" - DIN 8187 - ISO 606

3/4" x 7/16"

19,05 x 11,68 mm

**Rullo 12,07 mm
12B-1**

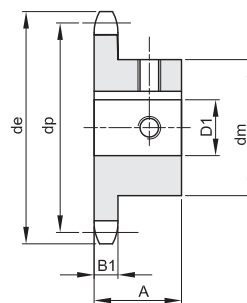
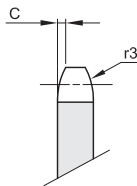

B1	C	r3
11,1	2	19

Materiale acciaio C45

Z	de	dp	dm	D1	A	Kg.
19	123,9	115,75	80	50	35	1,25
20	130,0	121,78	70	25	35	1,54
20	130,0	121,78	80	28	35	1,77
20	130,0	121,78	80	30	35	1,72
20	130,0	121,78	80	32	35	1,67
20	130,0	121,78	80	35	35	1,63
20	130,0	121,78	80	38	35	1,58
20	130,0	121,78	80	40	35	1,55
20	130,0	121,78	80	42	35	1,50
20	130,0	121,78	80	45	35	1,45
20	130,0	121,78	80	48	35	1,40
20	130,0	121,78	80	50	35	1,36
21	136,0	127,82	70	25	40	1,78
21	136,0	127,82	80	28	40	2,02
21	136,0	127,82	80	30	40	1,97
21	136,0	127,82	90	32	40	2,23
21	136,0	127,82	90	35	40	2,19
21	136,0	127,82	90	38	40	2,14
21	136,0	127,82	90	40	40	2,09
21	136,0	127,82	90	42	40	2,04
21	136,0	127,82	90	45	40	1,98
21	136,0	127,82	90	48	40	1,93
21	136,0	127,82	90	50	40	1,87
22	142,0	133,86	70	25	40	1,90
22	142,0	133,86	80	28	40	1,16
22	142,0	133,86	80	30	40	1,10
22	142,0	133,86	90	32	40	2,37
22	142,0	133,86	90	35	40	2,31
22	142,0	133,86	90	38	40	2,26
22	142,0	133,86	90	40	40	2,21
22	142,0	133,86	90	42	40	2,18
22	142,0	133,86	90	45	40	2,13
22	142,0	133,86	90	48	40	2,06
22	142,0	133,86	90	50	40	1,99
23	148,1	139,90	70	25	40	2,02
23	148,1	139,90	80	28	40	2,28
23	148,1	139,90	80	30	40	2,21
23	148,1	139,90	90	32	40	2,47
23	148,1	139,90	90	35	40	2,41
23	148,1	139,90	90	38	40	2,36
23	148,1	139,90	90	40	40	2,32
23	148,1	139,90	90	42	40	2,27
23	148,1	139,90	90	45	40	2,21

Z	de	dp	dm	D1	A	Kg.
23	148,1	139,90	90	48	40	2,15
23	148,1	139,90	90	50	40	2,10
24	154,1	145,94	70	25	40	2,14
24	154,1	145,94	80	28	40	2,37
24	154,1	145,94	80	30	40	2,32
24	154,1	145,94	90	32	40	2,60
24	154,1	145,94	90	35	40	2,54
24	154,1	145,94	90	38	40	2,49
24	154,1	145,94	90	40	40	2,44
24	154,1	145,94	90	42	40	2,39
24	154,1	145,94	90	45	40	2,34
24	154,1	145,94	90	48	40	2,28
24	154,1	145,94	90	50	40	2,23
25	160,2	152,00	70	25	40	2,25
25	160,2	152,00	80	28	40	2,51
25	160,2	152,00	80	30	40	2,45
25	160,2	152,00	90	32	40	2,71
25	160,2	152,00	90	35	40	2,67
25	160,2	152,00	90	38	40	2,62
25	160,2	152,00	90	40	40	2,58
25	160,2	152,00	90	42	40	2,52
25	160,2	152,00	90	45	40	2,46
25	160,2	152,00	90	48	40	2,41
25	160,2	152,00	90	50	40	2,36

PIGNONI PER CATENE A RULLI "SYSTEM BEA" - DIN 8187 - ISO 606

SPROCKETS FOR ROLLER CHAINS "SYSTEM BEA" - DIN 8187 - ISO 606

1" x 17,02 mm

25,4 x 17,02 mm

Rullo 15,88 mm

16B-1

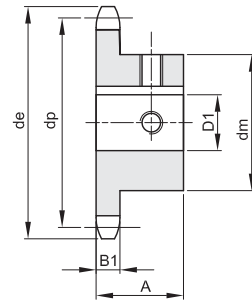
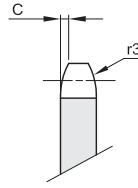

B1	C	r3
16,2	2,5	26

Materiale acciaio C45

Z	de	dp	dm	D1	A	Kg.	Z	de	dp	dm	D1	A	Kg.
11	101,7	90,14	61	25	40	1,12	15	133,7	122,17	92	38	40	2,25
11	101,7	90,14	61	28	40	1,09	15	133,7	122,17	92	40	40	2,21
11	101,7	90,14	61	30	40	1,06	15	133,7	122,17	92	42	40	2,15
11	101,7	90,14	61	32	40	1,02	15	133,7	122,17	92	45	40	2,08
11	101,7	90,14	61	35	40	0,98	15	133,7	122,17	92	48	40	2,03
11	101,7	90,14	65	38	40	0,97	15	133,7	122,17	92	50	40	1,99
11	101,7	90,14	67	40	40	0,99	16	141,8	130,20	80	25	45	2,59
11	101,7	90,14	67	42	40	0,97	16	141,8	130,20	80	28	45	2,50
12	109,7	98,14	69	25	40	1,42	16	141,8	130,20	80	30	45	2,47
12	109,7	98,14	69	28	40	1,39	16	141,8	130,20	100	32	45	3,09
12	109,7	98,14	69	30	40	1,35	16	141,8	130,20	100	35	45	3,01
12	109,7	98,14	69	32	40	1,31	16	141,8	130,20	100	38	45	2,94
12	109,7	98,14	69	35	40	1,27	16	141,8	130,20	100	40	45	2,89
12	109,7	98,14	69	38	40	1,22	16	141,8	130,20	100	42	45	2,84
12	109,7	98,14	69	40	40	1,17	16	141,8	130,20	100	45	45	2,78
12	109,7	98,14	69	42	40	1,13	16	141,8	130,20	100	48	45	2,70
13	117,7	106,12	70	25	40	1,59	16	141,8	130,20	100	50	45	2,65
13	117,7	106,12	78	28	40	1,61	17	149,8	138,22	80	25	45	2,75
13	117,7	106,12	78	30	40	1,63	17	149,8	138,22	80	28	45	2,70
13	117,7	106,12	78	32	40	1,62	17	149,8	138,22	80	30	45	2,67
13	117,7	106,12	78	35	40	1,61	17	149,8	138,22	100	32	45	3,30
13	117,7	106,12	78	38	40	1,56	17	149,8	138,22	100	35	45	3,21
13	117,7	106,12	78	40	40	1,51	17	149,8	138,22	100	38	45	3,15
13	117,7	106,12	78	42	40	1,48	17	149,8	138,22	100	40	45	3,09
13	117,7	106,12	78	45	40	1,45	17	149,8	138,22	100	42	45	3,02
13	117,7	106,12	78	48	40	1,41	17	149,8	138,22	100	45	45	2,97
13	117,7	106,12	78	50	40	1,37	17	149,8	138,22	100	48	45	2,91
14	125,7	114,15	70	25	40	1,83	17	149,8	138,22	100	50	45	2,84
14	125,7	114,15	80	28	40	1,95	18	157,8	146,28	80	25	45	2,97
14	125,7	114,15	80	30	40	1,92	18	157,8	146,28	80	28	45	2,92
14	125,7	114,15	80	32	40	1,89	18	157,8	146,28	80	30	45	2,89
14	125,7	114,15	84	35	40	1,91	18	157,8	146,28	100	32	45	3,47
14	125,7	114,15	84	38	40	1,86	18	157,8	146,28	100	35	45	3,42
14	125,7	114,15	84	40	40	1,83	18	157,8	146,28	100	38	45	3,37
14	125,7	114,15	84	42	40	1,75	18	157,8	146,28	100	40	45	3,32
14	125,7	114,15	84	45	40	1,71	18	157,8	146,28	100	42	45	3,25
14	125,7	114,15	84	48	40	1,66	18	157,8	146,28	100	45	45	3,19
14	125,7	114,15	84	50	40	1,61	18	157,8	146,28	100	48	45	3,12
15	133,7	122,17	70	25	40	1,94	18	157,8	146,28	100	50	45	3,06
15	133,7	122,17	80	28	40	2,12	19	165,9	154,33	80	25	45	3,21
15	133,7	122,17	80	30	40	2,09	19	165,9	154,33	80	28	45	3,18
15	133,7	122,17	80	32	40	2,03	19	165,9	154,33	80	30	45	3,12
15	133,7	122,17	92	35	40	2,30	19	165,9	154,33	100	32	45	3,71

PIGNONI PER CATENE A RULLI "SYSTEM BEA" - DIN 8187 - ISO 606

SPROCKETS FOR ROLLER CHAINS "SYSTEM BEA" - DIN 8187 - ISO 606

1" x 17,02 mm

25,4 x 17,02 mm

Rullo 15,88 mm

16B-1

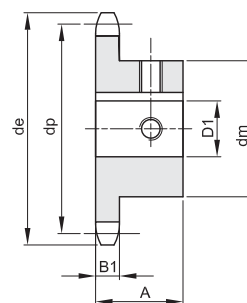
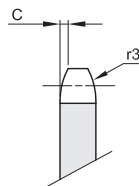

B1	C	r3
16,2	2,5	26

Materiale acciaio C45

Z	de	dp	dm	D1	A	Kg.	Z	de	dp	dm	D1	A	Kg.
19	165,9	154,33	100	35	45	3,67	23	198,1	186,53	100	32	50	5,08
19	165,9	154,33	100	38	45	3,61	23	198,1	186,53	100	35	50	5,01
19	165,9	154,33	100	40	45	3,56	23	198,1	186,53	100	38	50	4,93
19	165,9	154,33	100	42	45	3,51	23	198,1	186,53	110	40	50	5,32
19	165,9	154,33	100	45	45	3,46	23	198,1	186,53	110	42	50	5,28
19	165,9	154,33	100	48	45	3,38	23	198,1	186,53	110	45	50	5,22
19	165,9	154,33	100	50	45	3,30	23	198,1	186,53	110	48	50	5,17
20	173,9	162,38	80	25	45	3,46	23	198,1	186,53	110	50	50	5,11
20	173,9	162,38	80	28	45	3,41	24	206,2	194,59	80	25	50	4,79
20	173,9	162,38	80	30	45	3,37	24	206,2	194,59	80	28	50	4,73
20	173,9	162,38	100	32	45	3,95	24	206,2	194,59	80	30	50	4,68
20	173,9	162,38	100	35	45	3,90	24	206,2	194,59	100	32	50	5,37
20	173,9	162,38	100	38	45	3,84	24	206,2	194,59	100	35	50	5,31
20	173,9	162,38	100	40	45	3,79	24	206,2	194,59	100	38	50	5,26
20	173,9	162,38	100	42	45	3,72	24	206,2	194,59	110	40	50	5,63
20	173,9	162,38	100	45	45	3,65	24	206,2	194,59	110	42	50	5,54
20	173,9	162,38	100	48	45	3,60	24	206,2	194,59	110	45	50	5,46
20	173,9	162,38	100	50	45	3,55	24	206,2	194,59	110	48	50	5,39
21	182,0	170,43	80	25	50	3,92	24	206,2	194,59	110	50	50	5,32
21	182,0	170,43	80	28	50	3,86	25	214,2	202,66	80	25	50	5,11
21	182,0	170,43	80	30	50	3,81	25	214,2	202,66	80	28	50	5,04
21	182,0	170,43	100	32	50	4,52	25	214,2	202,66	80	30	50	4,97
21	182,0	170,43	100	35	50	4,45	25	214,2	202,66	100	32	50	5,67
21	182,0	170,43	100	38	50	4,38	25	214,2	202,66	100	35	50	5,60
21	182,0	170,43	110	40	50	4,75	25	214,2	202,66	100	38	50	5,53
21	182,0	170,43	110	42	50	4,70	25	214,2	202,66	110	40	50	5,92
21	182,0	170,43	110	45	50	4,63	25	214,2	202,66	110	42	50	5,84
21	182,0	170,43	110	48	50	4,54	25	214,2	202,66	110	45	50	5,77
21	182,0	170,43	110	50	50	4,48	25	214,2	202,66	110	48	50	5,70
22	190,1	178,48	80	25	50	4,19	25	214,2	202,66	110	50	50	5,64
22	190,1	178,48	80	28	50	4,13							
22	190,1	178,48	80	30	50	4,08							
22	190,1	178,48	100	32	50	4,79							
22	190,1	178,48	100	35	50	4,72							
22	190,1	178,48	100	38	50	4,66							
22	190,1	178,48	110	40	50	5,04							
22	190,1	178,48	110	42	50	5,00							
22	190,1	178,48	110	45	50	4,94							
22	190,1	178,48	110	48	50	4,88							
22	190,1	178,48	110	50	50	4,82							
23	198,1	186,53	80	25	50	4,48							
23	198,1	186,53	80	28	50	4,42							
23	198,1	186,53	80	30	50	4,35							

PIGNONI PER CATENE A RULLI "SYSTEM BEA" - DIN 8187 - ISO 606

SPROCKETS FOR ROLLER CHAINS "SYSTEM BEA" - DIN 8187 - ISO 606

Temperati ad induzione sui denti (HRc 50)
Diametro fori in tolleranza H7 - Rugosità RA 1,6
Cave Linguetto secondo DIN 6885 / UNI 6604 in asse al dente
N° 2 fori per viti di fissaggio



Teeth: inductioned hardness (HRc 50)
 Final bore tolerance H7 - Roughness value RA 1,6
 Keyway to DIN 6885 / BS 4235 is located on the center line of tooth
 Two grub screw holes

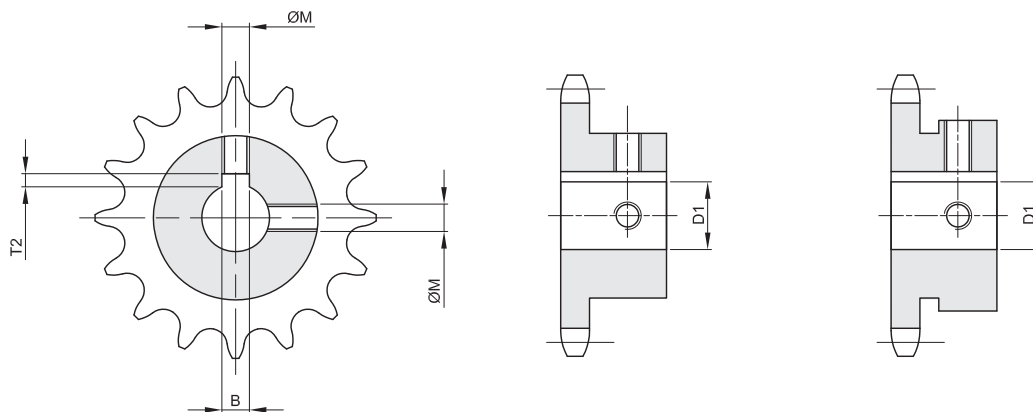

diametro fori D1	larghezza cava B	profondità cava T2	diametro vite Ø M
Ø10 H7 $\begin{matrix} +0,015 \\ -0 \end{matrix}$	3 H9 $\begin{matrix} +0,025 \\ -0 \end{matrix}$	1,4 $\begin{matrix} +0,10 \\ -0 \end{matrix}$	M4
Ø12 H7 $\begin{matrix} +0,018 \\ -0 \end{matrix}$	4 H9 $\begin{matrix} +0,030 \\ -0 \end{matrix}$	1,8 $\begin{matrix} +0,10 \\ -0 \end{matrix}$	M4
Ø14 H7 $\begin{matrix} +0,018 \\ -0 \end{matrix}$	5 H9 $\begin{matrix} +0,030 \\ -0 \end{matrix}$	2,3 $\begin{matrix} +0,10 \\ -0 \end{matrix}$	M4
Ø15 H7 $\begin{matrix} +0,018 \\ -0 \end{matrix}$	5 H9 $\begin{matrix} +0,030 \\ -0 \end{matrix}$	2,3 $\begin{matrix} +0,10 \\ -0 \end{matrix}$	M4
Ø16 H7 $\begin{matrix} +0,018 \\ -0 \end{matrix}$	5 H9 $\begin{matrix} +0,030 \\ -0 \end{matrix}$	2,3 $\begin{matrix} +0,10 \\ -0 \end{matrix}$	M4
Ø18 H7 $\begin{matrix} +0,018 \\ -0 \end{matrix}$	6 H9 $\begin{matrix} +0,030 \\ -0 \end{matrix}$	2,8 $\begin{matrix} +0,10 \\ -0 \end{matrix}$	M5
Ø19 H7 $\begin{matrix} +0,021 \\ -0 \end{matrix}$	6 H9 $\begin{matrix} +0,030 \\ -0 \end{matrix}$	2,8 $\begin{matrix} +0,10 \\ -0 \end{matrix}$	M5
Ø20 H7 $\begin{matrix} +0,021 \\ -0 \end{matrix}$	6 H9 $\begin{matrix} +0,030 \\ -0 \end{matrix}$	2,8 $\begin{matrix} +0,10 \\ -0 \end{matrix}$	M5
Ø22 H7 $\begin{matrix} +0,021 \\ -0 \end{matrix}$	6 H9 $\begin{matrix} +0,030 \\ -0 \end{matrix}$	2,8 $\begin{matrix} +0,10 \\ -0 \end{matrix}$	M5
Ø24 H7 $\begin{matrix} +0,021 \\ -0 \end{matrix}$	8 H9 $\begin{matrix} +0,036 \\ -0 \end{matrix}$	3,3 $\begin{matrix} +0,20 \\ -0 \end{matrix}$	M6
Ø25 H7 $\begin{matrix} +0,021 \\ -0 \end{matrix}$	8 H9 $\begin{matrix} +0,036 \\ -0 \end{matrix}$	3,3 $\begin{matrix} +0,20 \\ -0 \end{matrix}$	M6
Ø28 H7 $\begin{matrix} +0,021 \\ -0 \end{matrix}$	8 H9 $\begin{matrix} +0,036 \\ -0 \end{matrix}$	3,3 $\begin{matrix} +0,20 \\ -0 \end{matrix}$	M6
Ø30 H7 $\begin{matrix} +0,021 \\ -0 \end{matrix}$	8 H9 $\begin{matrix} +0,036 \\ -0 \end{matrix}$	3,3 $\begin{matrix} +0,20 \\ -0 \end{matrix}$	M6
Ø32 H7 $\begin{matrix} +0,025 \\ -0 \end{matrix}$	10 H9 $\begin{matrix} +0,036 \\ -0 \end{matrix}$	3,3 $\begin{matrix} +0,20 \\ -0 \end{matrix}$	M8
Ø35 H7 $\begin{matrix} +0,025 \\ -0 \end{matrix}$	10 H9 $\begin{matrix} +0,036 \\ -0 \end{matrix}$	3,3 $\begin{matrix} +0,20 \\ -0 \end{matrix}$	M8
Ø38 H7 $\begin{matrix} +0,025 \\ -0 \end{matrix}$	10 H9 $\begin{matrix} +0,036 \\ -0 \end{matrix}$	3,3 $\begin{matrix} +0,20 \\ -0 \end{matrix}$	M8
Ø40 H7 $\begin{matrix} +0,025 \\ -0 \end{matrix}$	12 H9 $\begin{matrix} +0,043 \\ -0 \end{matrix}$	3,3 $\begin{matrix} +0,20 \\ -0 \end{matrix}$	M10
Ø42 H7 $\begin{matrix} +0,025 \\ -0 \end{matrix}$	12 H9 $\begin{matrix} +0,043 \\ -0 \end{matrix}$	3,3 $\begin{matrix} +0,20 \\ -0 \end{matrix}$	M10
Ø45 H7 $\begin{matrix} +0,025 \\ -0 \end{matrix}$	14 H9 $\begin{matrix} +0,043 \\ -0 \end{matrix}$	3,8 $\begin{matrix} +0,20 \\ -0 \end{matrix}$	M12
Ø48 H7 $\begin{matrix} +0,025 \\ -0 \end{matrix}$	14 H9 $\begin{matrix} +0,043 \\ -0 \end{matrix}$	3,8 $\begin{matrix} +0,20 \\ -0 \end{matrix}$	M12
Ø50 H7 $\begin{matrix} +0,025 \\ -0 \end{matrix}$	14 H9 $\begin{matrix} +0,043 \\ -0 \end{matrix}$	3,8 $\begin{matrix} +0,20 \\ -0 \end{matrix}$	M12

PIGNONI PER CATENE A RULLI - DIN 8187 - ISO 606

SPROCKETS FOR ROLLER CHAINS - DIN 8187 - ISO 606

5 x 2,5 mm

Rullo 3,2 mm

03 - 1

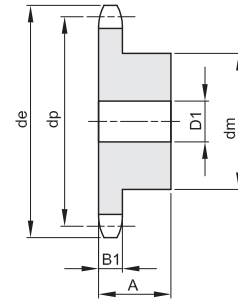
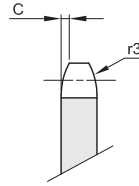

B1	B2	B3	b1	C	r3
2,3				0,4	5

Materiale acciaio C45

Z	de	dp	semplici				doppi				tripli				
			dm	D1	A	Kg.	dm	D2	A	Kg.	dm	D3	A	Kg.	
8	14,8	13,06	7	4	10	0,01									
9	16,4	14,62	8	5	10	0,01									
10	17,9	16,18	9	5	10	0,01									
11	19,5	17,75	11	6	10	0,01									
12	21,1	19,32	12	6	10	0,01									
13	22,6	20,89	14	6	10	0,01									
14	24,2	22,47	15	6	10	0,02									
15	25,8	24,04	16	6	10	0,02									
16	27,4	25,63	18	8	13	0,02									
17	29,0	27,20	18	8	13	0,03									
18	30,5	28,79	18	8	13	0,03									
19	32,1	30,38	18	8	13	0,03									
20	33,7	31,96	18	8	13	0,03									
21	35,3	33,54	20	8	13	0,04									
22	36,9	35,13	20	8	13	0,04									
23	38,5	36,72	20	8	13	0,04									
24	40,1	38,30	20	8	13	0,04									
25	41,6	39,89	20	8	13	0,04									
26	43,2	41,48													
27	44,8	43,07	25	8	15	0,07									
28	46,4	44,65	25	8	15	0,07									
29	48,0	46,25	25	8	15	0,07									
30	49,6	47,83	25	8	15	0,07									
31	51,2	49,42	30	8	15	0,10									
32	52,8	51,01	30	8	15	0,10									
33	54,4	52,60	30	8	15	0,10									
34	55,9	54,19	30	8	15	0,10									
35	57,5	55,78	30	8	15	0,11									
36	59,1	57,37													
37	60,7	58,96	30	8	15	0,11									
38	62,3	60,54	30	8	15	0,11									
39	63,9	62,13	30	8	15	0,12									
40	65,5	63,73	30	8	15	0,12									

PIGNONI PER CATENE A RULLI - DIN 8187 - ISO 606

SPROCKETS FOR ROLLER CHAINS - DIN 8187 - ISO 606

6 x 2,8 mm

Rullo 4 mm

04 - 1

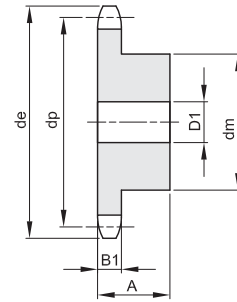
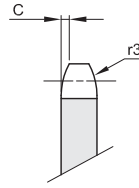

B1	B2	B3	b1	C	r3
2,6				0,6	6

Materiale acciaio C45 / *Materiale Fe - con mozzo saldato

Z	de	dp	semplici				doppi				tripli			
			dm	D1	A	Kg.	dm	D2	A	Kg.	dm	D3	A	Kg.
8	18,0	15,67	9,8	5	10	0,01								
9	19,9	17,54	11,5	5	10	0,01								
10	21,7	19,42	13	6	10	0,01								
11	23,6	21,30	14	6	10	0,01								
12	25,4	23,18	16	6	10	0,02								
13	27,3	25,05	18	6	10	0,02								
14	29,2	26,96	20	6	10	0,03								
15	31,1	28,86	20	6	10	0,03								
16	33,0	30,76	20	8	13	0,03								
17	35,0	32,65	20	8	13	0,04								
18	36,9	34,55	20	8	13	0,04								
19	38,8	36,44	20	8	13	0,04								
20	40,7	38,34	20	8	13	0,04								
21	42,6	40,25	25	8	13	0,06								
22	44,5	42,16	25	8	13	0,06								
23	46,4	44,06	25	8	13	0,06								
24	48,3	45,96	25	8	13	0,07								
25	50,2	47,87	25	8	13	0,07								
26	52,1	49,77	30	8	15	0,10								
27	54,0	51,67	30	8	15	0,10								
28	55,9	53,58	30	8	15	0,11								
29	57,8	55,50	30	8	15	0,11								
30	59,8	57,42	30	8	15	0,11								
31	61,7	59,31	30	10	15	0,11								
32	63,6	61,21	30	10	15	0,12								
33	65,5	63,11	30	10	15	0,12								
34	67,4	65,02	30	10	15	0,12								
35	69,3	66,93	30	10	15	0,13								
36	71,2	68,84	30	10	15	0,13								
37	73,1	70,75	30	10	15	0,14								
38	75,0	72,66	30	10	15	0,14								
39	76,9	74,56	30	10	15	0,14								
40	78,9	76,47	30	10	15	0,15								
45	88,5	86,01	62	12	18	0,46								
48	94,2	91,74	62	12	18	0,48								
50	98,0	95,55	62	12	18	0,49								
57	111,4	108,93	62	12	18	0,53								
60	117,5	114,62	*62	12	20	0,68								
76	148,1	145,19	*80	16	34	1,58								

PIGNONI PER CATENE A RULLI - DIN 8187 - ISO 606

SPROCKETS FOR ROLLER CHAINS - DIN 8187 - ISO 606

8 x 3,0 mm

Rullo 5 mm

05B - 1 - 2

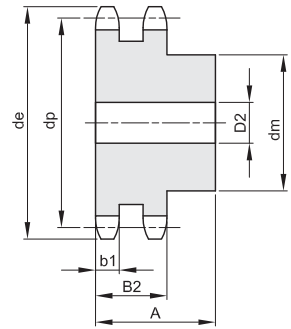
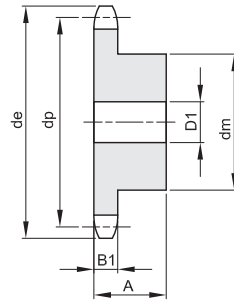
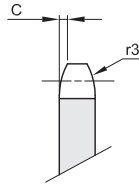

B1	B2	B3	b1	C	r3
2,8	8,3		2,7	0,8	8

Materiale acciaio C45 / *Materiale Fe - con mozzo saldato

Z	de	dp	semplici				doppi				tripli			
			dm	D1	A	Kg.	dm	D2	A	Kg.	dm	D3	A	Kg.
8	23,4	20,90	13	6	12	0,01	12	6	18	0,02				
9	25,9	23,39	15	6	12	0,02	15	6	18	0,03				
10	28,4	25,89	17	6	12	0,02	17	8	18	0,03				
11	31,0	28,39	18	7	13	0,03	19	8	18	0,04				
12	33,7	30,91	20	7	13	0,04	21	8	18	0,05				
13	36,7	33,42	23	7	13	0,05	24	8	18	0,07				
14	39,2	35,95	25	7	13	0,05	26	8	18	0,08				
15	41,7	38,48	28	7	13	0,07	29	8	18	0,10				
16	44,2	41,01	30	8	14	0,08	32	10	20	0,13				
17	46,7	43,53	30	8	14	0,09	34	10	20	0,15				
18	49,2	46,07	30	8	14	0,09	37	10	20	0,17				
19	51,7	48,61	30	8	14	0,09	39	10	20	0,20				
20	54,2	51,14	30	8	14	0,10	40	10	20	0,21				
21	57,2	53,67	35	8	14	0,12	45	12	20	0,25				
22	59,4	56,21	35	8	14	0,13	45	12	20	0,26				
23	62,2	58,75	35	8	14	0,13	45	12	20	0,28				
24	64,7	61,29	35	8	14	0,14	45	12	20	0,23				
25	67,2	63,83	35	8	14	0,15	45	12	20	0,31				
26	69,7	66,37	40	10	16	0,19	50	12	22	0,38				
27	72,3	68,91	40	10	16	0,20	50	12	22	0,40				
28	74,7	71,45	40	10	16	0,20								
29	77,2	73,99	40	10	16	0,21								
30	80,2	76,53	40	10	16	0,22	50	12	22	0,45				
31	82,7	79,08	40	12	16	0,22								
32	85,2	81,61	40	12	16	0,22	60	12	22	0,59				
33	87,7	84,16	40	12	16	0,23								
34	90,2	86,70	40	12	16	0,24								
35	92,7	89,24	40	12	16	0,25	60	12	22	0,65				
36	95,2	91,79	40	12	16	0,25	60	12	22	0,67				
37	97,7	94,33	40	12	16	0,26								
38	100,2	96,88	40	12	16	0,27	60	12	22	0,72				
39	102,7	99,42	40	12	16	0,28								
40	105,7	101,97	40	12	16	0,29	60	12	22	0,77				
45	118,6	114,69	60	12	20	0,58								
48	125,5	122,32	*62	12	20	0,67								
50	131,5	127,41	*62	12	20	0,63								
57	149,3	145,22	*80	14	20	1,00								
60	156,0	152,85	*80	16	34	1,53								
76	196,7	193,59	*80	20	34	1,94								

PIGNONI PER CATENE A RULLI - DIN 8187 - ISO 606

SPROCKETS FOR ROLLER CHAINS - DIN 8187 - ISO 606

3/8" x 7/32"

9,525 x 5,72 mm

Rullo 6,35 mm

06B - 1 - 2 - 3

B1	B2	B3	b1	C	r3
5,3	15,4	25,6	5,2	1	10

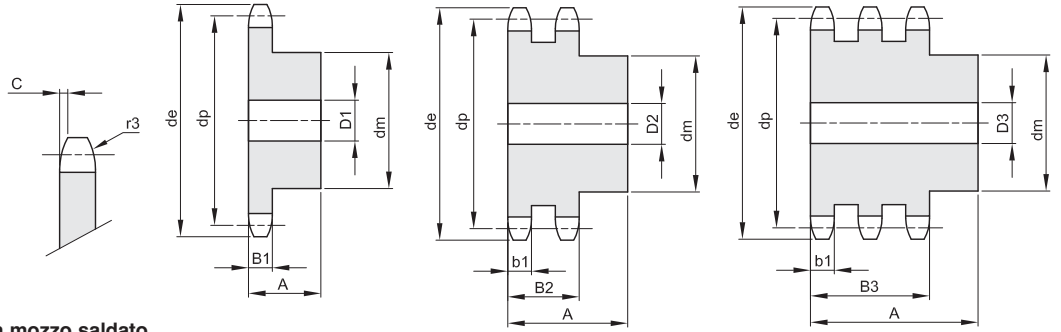

Materiale acciaio C45 / *Materiale Fe - con mozzo saldato

Z	de	dp	semplici				doppi				tripli			
			dm	D1	A	Kg.	dm	D2	A	Kg.	dm	D3	A	Kg.
8	28,6	24,89	15	8	20	0,03	15	8	25	0,04	15	8	32	0,05
9	31,5	27,85	18	8	20	0,04	18	8	25	0,05	18	8	32	0,07
10	34,5	30,82	20	8	20	0,05	20	8	25	0,07	20	10	32	0,09
11	37,5	33,80	22	8	25	0,08	22	10	30	0,10	22	12	35	0,11
12	40,5	36,80	25	8	25	0,10	25	10	30	0,13	25	12	35	0,15
13	43,5	39,80	28	8	25	0,13	28	10	30	0,16	28	12	35	0,19
14	46,5	42,80	31	8	25	0,16	31	10	30	0,20	31	12	35	0,23
15	49,5	45,81	34	8	25	0,19	34	10	30	0,24	34	12	35	0,28
16	52,5	48,82	37	10	28	0,24	37	12	30	0,27	37	12	35	0,33
17	55,5	51,83	40	10	28	0,28	40	12	30	0,32	40	12	35	0,39
18	58,6	54,85	43	10	28	0,33	43	12	30	0,38	43	12	35	0,45
19	61,6	57,87	45	10	28	0,36	46	12	30	0,42	46	12	35	0,51
20	64,6	60,89	46	10	28	0,39	49	12	30	0,48	49	12	35	0,58
21	67,6	63,91	48	12	28	0,42	52	16	30	0,52	52	16	40	0,70
22	70,6	66,93	50	12	28	0,46	55	16	30	0,58	55	16	40	0,78
23	73,7	69,95	52	12	28	0,50	58	16	30	0,64	58	16	40	0,87
24	76,7	72,97	54	12	28	0,54	61	16	30	0,71	61	16	40	0,97
25	79,7	76,00	57	12	28	0,60	64	16	30	0,79	64	16	40	1,06
26	82,7	79,02	60	12	28	0,66	67	16	30	0,87	67	16	40	1,17
27	85,7	82,04	60	12	28	0,67	70	16	30	0,94	70	16	40	1,27
28	88,8	85,07	60	12	28	0,69	73	16	30	1,03	73	16	40	1,39
29	91,8	88,09	60	12	28	0,70	76	16	30	1,11	76	16	40	1,50
30	94,8	91,12	60	12	30	0,72	79	16	30	1,20	79	16	40	1,62
31	97,9	94,15	65	14	30	0,87	80	16	30	1,27	80	16	40	1,72
32	100,9	97,17	65	14	30	0,89	80	16	30	1,32	80	16	40	1,80
33	103,9	100,20	65	14	30	0,91	80	16	30	1,37	80	16	40	1,89
34	106,9	103,23	65	14	30	0,92	80	16	30	1,43	85	16	40	2,06
35	110,0	106,26	65	14	30	0,95	80	16	30	1,49	85	16	40	2,15
36	113,0	109,29	70	16	30	1,05	90	16	30	1,70	90	16	40	2,33
37	116,0	112,32	70	16	30	1,09	90	16	30	1,76	90	16	40	2,43
38	119,0	115,34	70	16	30	1,10	90	16	30	1,81	90	16	40	2,53
39	122,1	118,37	70	16	30	1,12	90	16	30	1,88	90	16	40	2,63
40	125,1	121,40	70	16	30	1,14	90	16	30	1,95	90	16	40	2,74
42	132,1	127,46	*78	16	35	1,56	*88	20	50	2,44				
45	141,1	136,54	*78	16	35	1,66	*88	20	50	3,15	*88	20	60	4,15
46	144,2	139,58	*78	16	35	1,67								
48	150,2	145,64	*78	16	35	1,75	*88	20	50	3,43				
50	156,3	151,69	*78	20	35	1,80	*88	20	50	3,53	*88	20	60	4,80
55	171,4	166,85	*78	20	35	1,89								
57	177,5	172,91	*78	20	35	1,96	*88	20	50	4,16	*88	25	60	5,80
60	186,6	181,99	*78	20	35	2,03	*88	20	50	4,45	*88	25	60	6,21
76	235,1	230,49	*78	20	35	2,67	*88	25	50	6,23	*88	25	60	9,26
95	292,7	288,08	*88	25	40	4,06	*108	25	50	9,76	*120	25	60	15,18

PIGNONI PER CATENE A RULLI - DIN 8187 - ISO 606
SPROCKETS FOR ROLLER CHAINS - DIN 8187 - ISO 606

1/2" x 1/8"
12,7 x 3,3 mm
Rullo 7,75 mm
081 - 1

B1	B2	B3	b1	C	r3
3				0,8	13

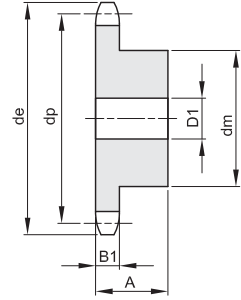
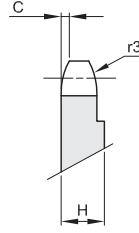
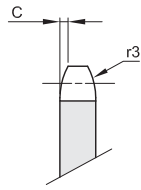

Da Z 31 H=4 mm

Materiale acciaio C45

Z	de	dp	semplici				doppi				tripli				
			dm	D1	A	Kg.	dm	D2	A	Kg.	dm	D3	A	Kg.	
8	39,5	33,18	21	8	14	0,04									
9	43,4	37,13	25	8	14	0,06									
10	47,4	41,10	28	8	14	0,07									
11	51,4	45,07	31	8	16	0,10									
12	55,4	49,07	35	8	16	0,13									
13	59,4	53,06	39	8	16	0,16									
14	63,4	57,07	43	8	16	0,19									
15	67,4	61,09	47	8	16	0,23									
16	71,4	65,10	50	10	18	0,29									
17	75,4	69,11	50	10	18	0,30									
18	79,4	73,14	50	10	18	0,31									
19	83,5	77,16	50	10	18	0,32									
20	87,5	81,19	50	10	18	0,33									
21	91,5	85,22	60	12	20	0,48									
22	95,5	89,24	60	12	20	0,49									
23	99,6	93,27	60	12	20	0,51									
24	103,6	97,29	60	12	20	0,52									
25	107,6	101,33	60	12	20	0,53									
26	111,7	105,36	70	16	20	0,67									
27	115,7	109,40	70	16	20	0,69									
28	119,7	113,42	70	16	20	0,70									
29	123,8	117,46	70	16	20	0,72									
30	127,8	121,50	70	16	20	0,74									
31	131,8	125,54													
32	135,9	129,56	70	16	20	0,77									
33	139,9	133,60													
34	143,9	137,64	70	16	20	0,81									
35	148,0	141,68	70	16	20	0,83									
36	152,0	145,72	70	16	25	1,00									
37	156,1	149,76	70	16	25	1,02									
38	160,1	153,80	70	16	25	1,04									
39	164,1	157,83	70	16	25	1,06									
40	168,2	161,87	70	16	25	1,09									

PIGNONI PER CATENE A RULLI - DIN 8187 - ISO 606

SPROCKETS FOR ROLLER CHAINS - DIN 8187 - ISO 606

1/2" x 3/16"
12,7 x 4,88 mm
Rullo 7,75 mm
083 - 1 / 084 - 1

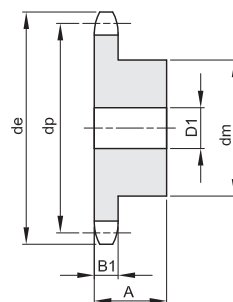
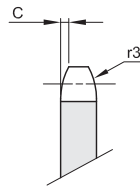

B1	B2	B3	b1	C	r3
4,50				1,3	13

Materiale acciaio C45

Z	de	dp	semplici				doppi				tripli				
			dm	D1	A	Kg.	dm	D2	A	Kg.	dm	D3	A	Kg.	
8	39,5	33,18	21	8	14	0,04									
9	43,4	37,13	25	8	14	0,06									
10	47,4	41,10	28	8	14	0,08									
11	51,4	45,07	31	8	16	0,11									
12	55,4	49,07	35	8	16	0,14									
13	59,4	53,06	39	8	16	0,17									
14	63,4	57,07	43	8	16	0,20									
15	67,4	61,09	47	8	16	0,24									
16	71,4	65,10	50	10	18	0,30									
17	75,4	69,11	50	10	18	0,31									
18	79,4	73,14	50	10	18	0,33									
19	83,5	77,16	50	10	18	0,34									
20	87,5	81,19	50	10	18	0,36									
21	91,5	85,22	60	12	20	0,51									
22	95,5	89,24	60	12	20	0,53									
23	99,6	93,27	60	12	20	0,55									
24	103,6	97,29	60	12	20	0,57									
25	107,6	101,33	60	12	20	0,59									
26	111,7	105,36	70	16	20	0,72									
27	115,7	109,40	70	16	20	0,74									
28	119,7	113,42	70	16	20	0,77									
29	123,8	117,46	70	16	20	0,79									
30	127,8	121,50	70	16	20	0,82									
31	131,8	125,54	70	16	20	0,85									
32	135,9	129,56	70	16	20	0,87									
33	139,9	133,60	70	16	20	0,90									
34	143,9	137,64	70	16	20	0,93									
35	148,0	141,68	70	16	20	0,96									
36	152,0	145,72	70	16	25	1,14									
37	156,1	149,76	70	16	25	1,17									
38	160,1	153,80	70	16	25	1,20									
39	164,1	157,83	70	16	25	1,24									
40	168,2	161,87	70	16	25	1,27									

PIGNONI PER CATENE A RULLI - DIN 8187 - ISO 606

SPROCKETS FOR ROLLER CHAINS - DIN 8187 - ISO 606

1/2" x 5/16"
12,7 x 7,75 mm
Rullo 8,51 mm
08B - 1 - 2 - 3

B1	B2	B3	b1	C	r3
7,2	21	34,9	7	1,3	13

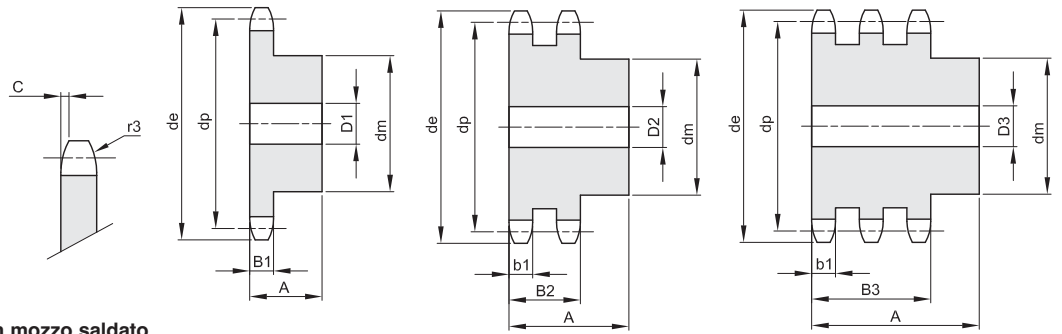

Materiale acciaio C45 / *Materiale Fe - con mozzo saldato

Z	de	dp	semplici				doppi				tripli			
			dm	D1	A	Kg.	dm	D2	A	Kg.	dm	D3	A	Kg.
8	38,0	33,18	20	10	25	0,06	20	10	32	0,09	20	10	46	0,13
9	42,0	37,13	24	10	25	0,09	24	10	32	0,13	24	12	46	0,18
10	45,9	41,10	26	10	25	0,12	28	10	32	0,18	28	12	46	0,24
11	49,9	45,07	29	10	25	0,15	32	12	35	0,24	32	16	50	0,31
12	53,9	49,07	33	10	28	0,21	35	12	35	0,30	35	16	50	0,39
13	57,9	53,06	37	10	28	0,26	38	12	35	0,36	38	16	50	0,49
14	61,9	57,07	41	10	28	0,32	42	12	35	0,44	42	16	50	0,60
15	65,9	61,09	45	10	28	0,38	46	12	35	0,52	46	16	50	0,72
16	69,9	65,10	50	12	28	0,46	50	16	38	0,63	50	16	50	0,85
17	74,0	69,11	52	12	28	0,51	54	16	38	0,73	54	16	50	0,99
18	78,0	73,14	56	12	28	0,59	58	16	38	0,85	58	16	50	1,14
19	82,0	77,16	60	12	28	0,67	62	16	38	0,97	62	16	50	1,30
20	86,0	81,19	64	12	28	0,76	66	16	38	1,10	66	16	50	1,47
21	90,1	85,22	68	14	28	0,85	70	16	40	1,29	70	16	55	1,79
22	94,1	89,24	70	14	28	0,91	70	16	40	1,37	70	16	55	1,93
23	98,1	93,27	70	14	28	0,95	70	16	40	1,46	70	16	55	2,08
24	102,1	97,29	70	14	28	0,98	75	16	40	1,64	75	16	55	2,32
25	106,2	101,33	70	14	28	1,01	80	16	40	1,82	80	16	55	2,57
26	110,2	105,36	70	16	30	1,09	85	16	40	2,02	85	20	55	2,79
27	114,2	109,40	70	16	30	1,13	85	16	40	2,12	85	20	55	2,96
28	118,3	113,42	70	16	30	1,17	90	16	40	2,34	90	20	55	3,25
29	122,3	117,46	80	16	30	1,42	95	16	40	2,56	95	20	55	3,55
30	126,3	121,50	80	16	30	1,46	100	16	40	2,79	100	20	55	3,86
31	130,4	125,54	90	16	30	1,74	100	20	40	2,87	110	20	55	4,32
32	134,4	129,56	90	16	30	1,78	100	20	40	3,00	110	20	55	4,53
33	138,4	133,60	90	16	30	1,83	100	20	40	3,13	110	20	55	4,74
34	142,5	137,64	90	16	30	1,88	100	20	40	3,26	110	20	55	4,97
35	146,5	141,68	90	16	30	1,93	100	20	40	3,40	110	20	55	5,20
36	150,6	145,72	90	16	35	2,22	100	20	40	3,54	120	25	55	5,64
37	154,6	149,76	90	16	35	2,27	100	20	40	3,69	120	25	55	5,88
38	158,6	153,80	90	16	35	2,32	100	20	40	3,84	120	25	55	6,14
39	162,7	157,83	90	16	35	2,38	100	20	40	4,00	120	25	55	6,40
40	166,7	161,87	90	16	35	2,43	100	20	40	4,15	120	25	55	6,66
42	176,5	169,95	*88	20	42	2,77	*108	20	55	5,67				
45	188,6	182,07	*88	20	42	3,00	*108	20	55	6,26	*120	25	68	9,12
46	192,6	186,10	*88	20	42	3,06	*108	20	55	6,39				
48	200,7	194,18	*88	20	42	3,16	*108	20	55	6,75				
50	208,8	202,26	*88	20	42	3,30	*108	20	55	7,17	*120	25	68	10,74
55	229,0	222,46	*88	20	42	3,62								
57	237,1	230,54	*88	20	42	3,85	*108	25	55	8,65	*120	25	68	13,26
60	249,2	242,66	*88	20	42	4,08	*108	25	55	9,35	*120	25	68	14,47
76	313,9	307,33	*88	25	42	5,56	*108	25	55	13,30	*120	25	68	21,78
95	390,7	384,11	*108	25	42	8,56	*120	25	55	21,13	*136	25	68	34,00

PIGNONI PER CATENE A RULLI - DIN 8187 - ISO 606

SPROCKETS FOR ROLLER CHAINS - DIN 8187 - ISO 606

5/8" x 3/8"
15,875 x 9,65 mm
Rullo 10,16 mm
10B - 1 - 2 - 3

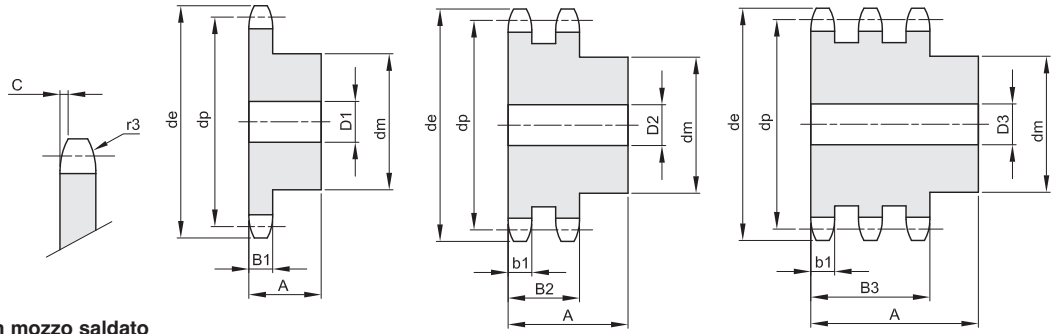

B1	B2	B3	b1	C	r3
9,1	25,5	42,1	9	1,6	16

Materiale acciaio C45 / *Materiale Fe - con mozzo saldato

Z	de	dp	semplici				doppi				tripli			
			dm	D1	A	Kg.	dm	D2	A	Kg.	dm	D3	A	Kg.
8	48,4	41,48	25	10	25	0,12	25	12	40	0,19	25	12	55	0,27
9	53,3	46,42	30	10	25	0,16	30	12	40	0,27	30	12	55	0,38
10	58,3	51,37	35	10	25	0,22	35	12	40	0,36	35	16	55	0,47
11	63,2	56,34	37	12	30	0,29	39	16	40	0,43	39	16	55	0,61
12	68,2	61,34	42	12	30	0,37	44	16	40	0,55	44	16	55	0,78
13	73,2	66,32	47	12	30	0,46	49	16	40	0,68	49	16	55	0,96
14	78,2	71,34	52	12	30	0,56	54	16	40	0,82	54	16	55	1,15
15	83,2	76,36	57	12	30	0,67	59	16	40	0,97	59	16	55	1,37
16	88,3	81,37	60	12	30	0,76	64	16	45	1,26	64	16	60	1,72
17	93,3	86,39	60	12	30	0,88	69	16	45	1,46	69	16	60	1,99
18	98,3	91,42	70	14	30	1,01	74	16	45	1,67	74	16	60	2,27
19	103,3	96,45	70	14	30	1,15	79	16	45	1,90	79	16	60	2,58
20	108,4	101,49	75	14	30	1,21	84	16	45	2,14	84	16	60	2,91
21	113,4	106,52	75	16	30	1,35	85	16	45	2,27	85	20	60	3,12
22	118,4	111,55	80	16	30	1,41	90	16	45	2,54	90	20	60	3,48
23	123,5	116,58	80	16	30	1,47	95	16	45	2,82	95	20	60	3,86
24	128,5	121,62	80	16	30	1,54	100	16	45	3,11	100	20	60	4,25
25	133,6	126,66	80	16	30	1,60	105	16	45	3,15	105	20	60	4,67
26	138,6	131,70	85	20	35	1,96	110	20	45	3,74	110	20	60	5,10
27	143,6	136,75	85	20	35	2,04	110	20	45	3,94	110	20	60	5,43
28	148,7	141,78	90	20	35	2,25	115	20	45	4,28	115	20	60	5,90
29	153,7	146,83	90	20	35	2,33	115	20	45	4,50	115	20	60	6,25
30	158,8	151,87	90	20	35	2,41	120	20	45	4,87	120	20	60	6,65
31	163,8	156,92	95	20	35	2,64	120	20	45	5,10	120	20	60	7,18
32	168,9	161,95	95	20	35	2,73	120	20	45	5,34	120	20	60	7,56
33	173,9	167,00	95	20	35	2,82	120	20	45	5,59	120	20	60	7,97
34	178,9	172,05	95	20	35	2,92	120	20	45	5,84	120	20	60	8,36
35	184,0	177,10	95	20	35	3,01	120	20	45	6,11	120	20	60	8,74
36	189,0	182,15	100	20	35	3,27	120	20	45	6,38	120	25	60	9,15
37	194,1	187,20	100	20	35	3,37	120	20	45	6,66	120	25	60	9,61
38	199,1	192,24	100	20	35	3,47	120	20	45	6,95	120	25	60	10,08
39	204,2	197,29	100	20	35	3,58	120	20	45	7,25	120	25	60	10,57
40	209,2	202,34	100	20	35	3,69	120	20	45	7,55	120	25	60	11,07
42	220,8	212,44	*108	20	43	4,73	*120	25	59	9,35				
45	236,0	227,58	*108	20	43	5,09	*120	25	59	10,32	*136	25	74	15,70
46	241,0	236,63	*108	20	43	5,19	*120	25	59	10,67				
48	251,1	242,73	*108	20	43	5,43	*120	25	59	11,40				
50	261,2	252,82	*108	20	43	5,70	*120	25	59	12,11	*136	25	74	18,83
55	286,5	278,08	*108	20	43	6,40								
57	296,6	288,18	*108	25	43	6,66	*120	25	59	15,74	*136	25	74	23,40
60	311,7	303,32	*108	25	43	7,15	*120	25	59	16,40	*136	25	74	25,80
76	392,5	384,16	*108	25	43	10,28	*120	25	59	24,93	*145	30	75	40,25
95	488,5	480,14	*118	30	59	16,36	*145	30	58	38,90	*145	30	75	55,35

PIGNONI PER CATENE A RULLI - DIN 8187 - ISO 606

SPROCKETS FOR ROLLER CHAINS - DIN 8187 - ISO 606

3/4" x 7/16"

19,05 x 11,68 mm

Rullo 12,07 mm

12B - 1 - 2 - 3

B1	B2	B3	b1	C	r3
11,1	30,3	49,8	10,8	2	19

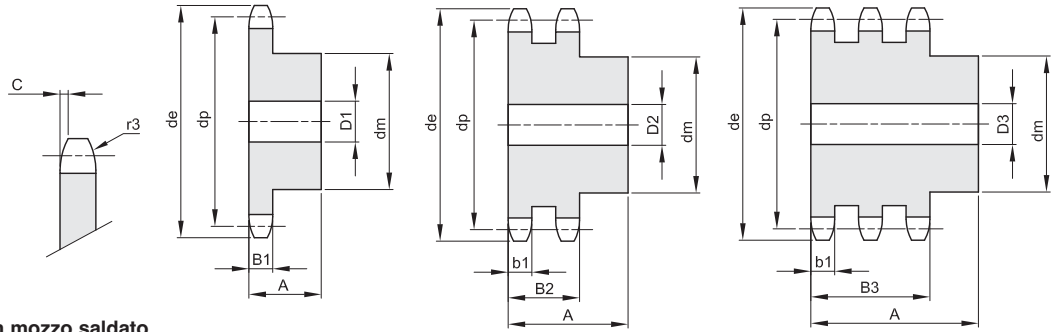

Materiale acciaio C45 / *Materiale Fe - con mozzo saldato

Z	de	dp	semplici				doppi				tripli			
			dm	D1	A	Kg.	dm	D2	A	Kg.	dm	D3	A	Kg.
8	58,0	49,78	31	12	30	0,21	31	12	45	0,31	31	16	65	0,45
9	63,9	55,70	37	12	30	0,29	37	12	45	0,44	37	16	65	0,64
10	69,8	61,64	42	12	30	0,38	42	12	45	0,59	42	16	65	0,86
11	75,8	67,61	46	16	35	0,51	47	16	50	0,81	47	20	70	1,09
12	81,8	73,60	52	16	35	0,65	53	16	50	1,02	53	20	70	1,39
13	87,8	79,59	58	16	35	0,80	59	16	50	1,25	59	20	70	1,72
14	93,8	85,61	64	16	35	0,97	65	16	50	1,46	65	20	70	2,08
15	99,8	91,63	70	16	35	1,16	71	16	50	1,74	71	20	70	2,47
16	105,8	97,65	75	16	35	1,34	77	20	50	2,03	77	20	70	2,89
17	111,9	103,67	80	16	35	1,53	83	20	50	2,36	83	20	70	3,34
18	117,9	109,71	80	16	35	1,62	89	20	50	2,70	89	20	70	3,83
19	123,9	115,75	80	16	35	1,70	95	20	50	3,07	95	20	70	4,35
20	130,0	121,78	80	16	35	1,80	100	20	50	3,43	100	20	70	4,87
21	136,0	127,82	90	20	40	2,35	100	20	50	3,69	100	20	70	5,20
22	142,0	133,86	90	20	40	2,46	100	20	50	3,97	100	20	70	5,65
23	148,1	139,90	90	20	40	2,56	110	20	50	4,51	110	20	70	6,38
24	154,1	145,94	90	20	40	2,68	110	20	50	4,81	110	20	70	6,87
25	160,2	152,00	90	20	40	2,80	120	20	50	5,41	120	20	70	7,77
26	166,2	158,04	95	20	40	3,08	120	20	50	5,73	120	20	70	8,21
27	172,3	164,09	95	20	40	3,21	120	20	50	6,08	120	20	70	8,77
28	178,3	170,13	95	20	40	3,34	120	20	50	6,43	120	20	70	9,35
29	184,4	176,19	95	20	40	3,48	120	20	50	6,80	120	20	70	9,96
30	190,4	182,25	95	20	40	3,63	120	20	50	7,19	120	20	70	10,59
31	196,5	188,31	95	20	40	3,78	120	20	50	7,59	130	25	70	11,55
32	202,5	194,35	95	20	40	3,93	120	20	50	8,00	130	25	70	12,22
33	208,6	200,40	95	20	40	4,09	120	20	50	8,42	130	25	70	12,92
34	214,6	206,46	95	20	40	4,25	120	20	50	8,86	130	25	70	13,64
35	220,7	212,52	95	20	40	4,42	120	20	50	9,31	130	25	70	14,38
36	226,8	218,58	100	20	40	4,71	120	25	50	9,71	130	25	70	15,14
37	232,8	224,64	100	20	40	4,89	120	25	50	10,19	130	25	70	15,93
38	238,9	230,69	100	20	40	5,07	120	25	50	10,78	130	25	70	16,73
39	244,9	236,75	100	20	40	5,26	120	25	50	11,19	130	25	70	17,57
40	251,0	242,81	100	20	40	5,46	120	25	50	11,71	130	25	70	18,42
42	265,0	254,93	*118	25	61	8,14	*136	25	62	14,51				
45	283,2	273,10	*118	25	61	8,85	*136	25	62	16,35	*140	25	72	23,55
46	289,2	279,16	*118	25	61	9,22	*136	25	62	16,80				
48	301,4	291,27	*118	25	61	9,67	*136	25	62	18,18				
50	313,5	303,39	*118	25	61	10,15	*136	25	62	19,44	*140	25	72	28,73
55	343,8	333,70	*118	25	61	11,29								
57	355,9	345,81	*118	25	61	11,85	*136	25	62	24,43	*140	30	75	37,16
60	374,1	363,99	*118	25	61	12,71	*136	25	62	26,77	*140	30	75	41,01
76	471,1	460,99	*118	30	61	18,02	*145	30	63	41,88	*150	30	75	65,41
95	586,2	576,17	*133	30	62	27,45	*145	30	63	63,79	*150	30	75	101,37

PIGNONI PER CATENE A RULLI - DIN 8187 - ISO 606

SPROCKETS FOR ROLLER CHAINS - DIN 8187 - ISO 606

1" x 17,02 mm

25,4 x 17,02 mm

Rullo 15,88 mm

16B - 1 - 2 - 3

B1	B2	B3	b1	C	r3
16,2	47,7	79,6	15,8	2,5	26

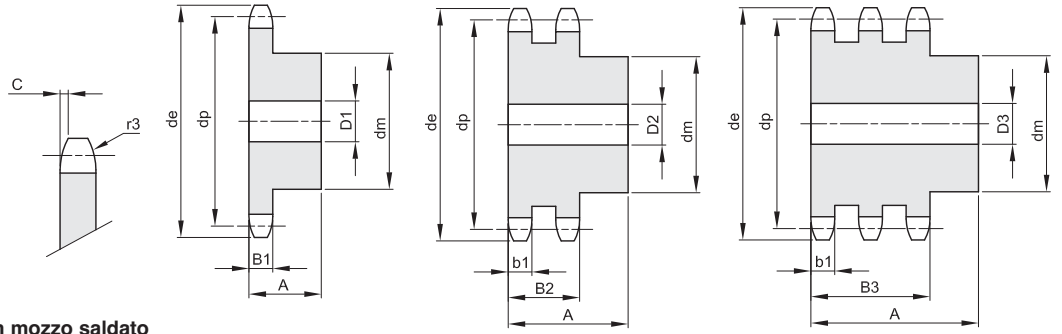

Materiale acciaio C45 / *Materiale Fe - con mozzo saldato

Z	de	dp	semplici				doppi				tripli			
			dm	D1	A	Kg.	dm	D2	A	Kg.	dm	D3	A	Kg.
8	77,9	66,37	42	16	35	0,47	42	20	65	0,81	42	20	95	1,19
9	85,8	74,27	50	16	35	0,66	50	20	65	1,15	50	20	95	1,68
10	93,8	82,19	55	16	35	0,83	56	20	65	1,52	56	20	95	2,24
11	101,7	90,14	61	16	40	1,14	64	20	70	2,08	64	25	100	2,86
12	109,7	98,14	69	16	40	1,43	72	20	70	2,60	72	25	100	3,62
13	117,7	106,12	78	16	40	1,77	80	20	70	3,18	80	25	100	4,45
14	125,7	114,15	84	16	40	2,08	88	20	70	3,82	88	25	100	5,37
15	133,7	122,17	92	16	40	2,46	96	20	70	4,51	96	25	100	6,37
16	141,8	130,20	100	20	45	3,14	104	20	70	5,17	104	25	100	7,45
17	149,8	138,22	100	20	45	3,33	112	20	70	5,98	112	25	100	8,60
18	157,8	146,28	100	20	45	3,56	120	20	70	6,84	120	25	100	9,84
19	165,9	154,33	100	20	45	3,78	128	20	70	7,76	128	25	100	11,16
20	173,9	162,38	100	20	45	4,03	130	20	70	8,52	130	25	100	12,36
21	182,0	170,43	110	20	50	5,01	130	25	70	9,24	130	25	100	13,56
22	190,1	178,48	110	20	50	5,28	130	25	70	10,00	130	25	100	14,82
23	198,1	186,53	110	20	50	5,56	130	25	70	10,80	130	25	100	16,15
24	206,2	194,59	110	20	50	5,86	130	25	70	11,64	130	25	100	17,53
25	214,2	202,66	110	20	50	6,16	130	25	70	12,52	130	25	100	18,99
26	222,3	210,72	120	20	50	6,96	130	25	70	13,43	130	30	100	20,34
27	230,4	218,79	120	20	50	7,30	130	25	70	14,38	130	30	100	21,92
28	238,4	226,85	120	20	50	7,64	130	25	70	15,38	130	30	100	23,57
29	246,5	234,92	120	20	50	8,00	130	25	70	16,41	130	30	100	25,27
30	254,6	243,00	120	20	50	8,38	130	25	70	17,48	130	30	100	27,05
31	262,6	251,08	120	25	50	8,69	140	25	70	18,96	140	30	100	29,23
32	270,7	259,13	120	25	50	9,09	140	25	70	20,10	140	30	100	31,13
33	278,8	267,21	120	25	50	9,50	140	25	70	21,29	140	30	100	33,10
34	286,9	275,28	120	25	50	9,93	140	25	70	22,21	140	30	100	35,13
35	294,9	283,36	120	25	50	10,36	140	25	70	23,77	140	30	100	37,23
36	303,0	291,44	120	25	50	10,81	140	25	70	25,07	140	30	100	39,39
37	311,1	299,51	120	25	50	11,28	140	25	70	26,41				
38	319,2	307,59	120	25	50	11,76	140	25	70	27,79	140	30	100	43,90
39	327,2	315,67	120	25	50	12,25	140	25	70	29,20				
40	335,3	323,73	120	25	50	12,75	140	25	70	30,65	140	30	100	48,67
42	353,7	339,90	*133	25	68	16,54	*140	25	70	33,63				
45	377,9	364,12	*133	25	68	18,15	*140	25	70	38,44	*160	30	110	63,94
46	386,0	372,21	*133	25	68	18,69	*140	25	70	40,13				
48	402,1	388,36	*133	25	68	19,86	*140	25	70	43,61				
50	418,3	404,52	*133	25	68	20,89	*140	25	70	47,25	*160	30	110	78,58
57	474,9	461,07	*133	30	68	25,52	*160	40	82	63,45	*180	40	112	103,03
60	499,1	485,32	*133	30	68	27,76	*160	40	82	70,00				
76	628,4	614,65	*145	30	68	42,97	*160	40	82	110,79	*180	40	112	181,86
95	782,0	768,22	*160	30	78	63,92	*180	40	109	178,48	*180	40	112	283,85

PIGNONI PER CATENE A RULLI - DIN 8187 - ISO 606

SPROCKETS FOR ROLLER CHAINS - DIN 8187 - ISO 606

1"1/4 x 3/4"

31,75 x 19,05 mm
Rullo 19,05 mm
20B - 1 - 2 - 3

B1	B2	B3	b1	C	r3
18,5	54,6	91	18,2	3,5	32

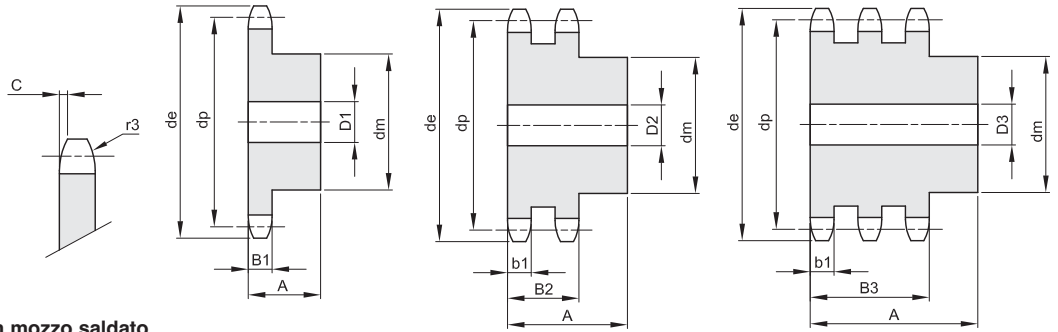

Materiale acciaio C45 / *Materiale Fe - con mozzo saldato

Z	de	dp	semplici				doppi				tripli			
			dm	D1	A	Kg.	dm	D2	A	Kg.	dm	D3	A	Kg.
8	96,0	82,96	53	20	40	0,85	53	20	75	1,58	53	25	110	2,15
9	106,5	92,84	63	20	40	1,19	63	20	75	2,19	63	25	110	3,05
10	117,0	102,74	70	20	40	1,51	70	20	75	2,85	70	25	110	4,04
11	127,0	112,68	77	20	45	2,04	80	25	80	3,72	80	30	115	5,19
12	137,0	122,68	88	20	45	2,58	90	25	80	4,66	90	30	115	6,55
13	147,5	132,65	98	20	45	3,15	100	25	80	5,70	100	30	115	8,06
14	157,6	142,68	108	20	45	3,78	110	25	80	6,84	110	30	115	9,71
15	167,7	152,72	118	20	45	4,47	120	25	80	8,08	120	30	115	11,50
16	177,7	162,75	120	25	50	5,25	120	30	80	8,90	120	30	115	13,06
17	187,7	172,78	120	25	50	5,61	120	30	80	9,92	120	30	115	14,65
18	197,8	182,85	120	25	50	6,00	120	30	80	11,00	120	30	115	16,54
19	207,9	192,91	120	25	50	6,40	120	30	80	12,16	120	30	115	18,45
20	217,9	202,98	120	25	50	6,84	120	30	80	13,38	120	30	115	20,48
21	228,0	213,04	140	25	55	8,79	140	30	80	15,49	140	30	115	23,38
22	238,1	223,11	140	25	55	9,27	140	30	80	16,86	140	30	115	25,64
23	248,2	233,17	140	25	55	9,77	140	30	80	18,29	140	30	115	28,00
24	258,3	243,23	140	25	55	10,30	140	30	80	19,79	140	30	115	30,49
25	268,4	253,33	140	25	55	10,85	140	30	80	21,36	140	30	115	33,09
26	278,4	263,40	150	30	55	12,07	150	30	80	23,45	150	30	115	36,23
27	288,5	273,48	150	30	55	12,67	150	30	80	25,15	150	30	115	39,06
28	298,5	283,56	150	30	55	13,29	150	30	80	26,93	150	30	115	42,00
29	308,6	293,65	150	30	55	13,93	150	30	80	28,77				
30	318,7	303,75	150	30	55	14,60	150	30	80	30,69	150	30	115	48,23
31	328,8	313,85	*150	30	55	15,28	*150	30	80	32,67				
32	338,9	323,91	*150	30	55	16,00	*150	30	80	34,72	*150	30	115	54,91
33	349,0	334,01	*150	30	55	16,73								
34	359,1	344,10	*150	30	55	17,49	*150	30	80	39,03	*150	30	115	62,06
35	369,2	354,20	*150	30	55	18,27	*150	30	80	41,28	*150	30	115	65,80
36	379,2	364,30	*150	30	55	19,08	*150	30	80	43,61	*150	30	115	69,66
37	389,3	374,39	*150	30	55	19,91								
38	399,4	384,49	*150	30	55	20,76	*150	30	80	48,46	*150	30	115	77,72
39	409,5	394,59	*150	30	55	21,73								
40	419,6	404,66	*150	30	55	22,53	*150	30	80	53,60	*150	30	115	86,24
42	440,8	424,88	*160	30	80	28,84								
45	471,1	455,17	*160	30	80	31,79	*160	30	101	71,32	*160	40	121	110,41
46	481,2	465,26	*160	30	80	32,83	*160	30	101	74,34				
48	501,4	485,46	*160	30	80	35,00								
50	521,6	505,65	*160	30	80	37,21	*160	30	101	87,08	*160	40	121	136,59
57	592,3	576,36	*160	30	80	45,79	*180	40	116	116,28	*200	40	123	181,21
60	622,6	606,65	*160	30	80	49,83								
76	784,3	768,32	*160	30	80	75,81	*180	40	116	200,96	*200	40	123	322,03
95	976,2	960,28	*168	30	93	114,96	*200	40	116	313,59				

PIGNONI PER CATENE A RULLI - DIN 8187 - ISO 606

SPROCKETS FOR ROLLER CHAINS - DIN 8187 - ISO 606

1"1/2 x 1"
38,1 x 25,4 mm
Rullo 25,4 mm
24B - 1 - 2 - 3

B1	B2	B3	b1	C	r3
24,1	72	120,3	23,6	4	38

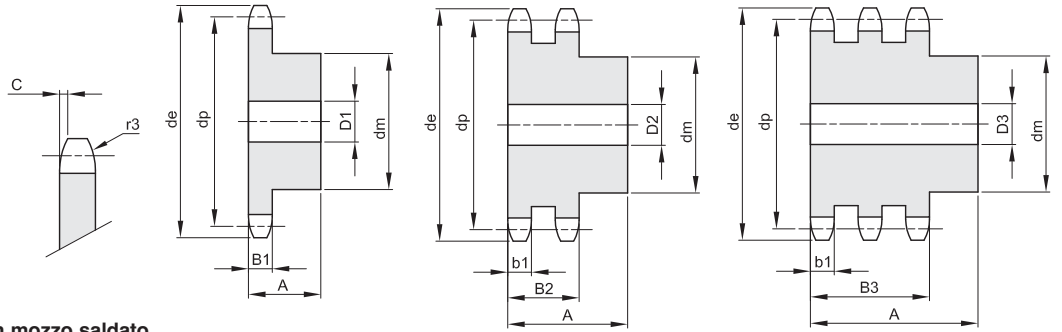

Materiale acciaio C45 / *Materiale Fe - con mozzo saldato

Z	de	dp	semplici				doppi				tripli			
			dm	D1	A	Kg.	dm	D2	A	Kg.	dm	D3	A	Kg.
8	113,0	99,55	58	20	45	1,38	58	25	95	2,70	58	25	140	4,00
9	125,0	111,40	70	20	45	1,90	70	25	95	3,79	70	25	140	5,62
10	137,0	123,29	80	20	45	2,47	80	25	95	5,01	80	25	140	7,45
11	149,0	135,21	90	25	50	3,27	90	25	100	6,62	90	30	150	9,73
12	161,0	147,22	102	25	50	4,09	102	25	100	8,28	102	30	150	12,24
13	173,0	159,18	114	25	50	5,00	114	25	100	10,13	114	30	150	15,02
14	185,0	171,22	128	25	50	6,09	128	25	100	12,24	128	30	150	18,16
15	197,0	183,26	132	25	50	6,84	132	25	100	14,08	132	30	150	21,09
16	209,0	195,30	136	25	55	8,20	136	30	100	15,88	136	30	150	24,25
17	221,0	207,34	136	25	55	8,87	136	30	100	17,80	136	30	150	27,42
18	233,0	219,42	136	25	55	9,59	160	30	100	21,08	160	30	150	32,12
19	245,5	231,49	136	25	55	10,36	160	30	100	23,26	160	30	150	35,74
20	257,5	243,57	136	25	55	11,16	160	30	100	25,57	160	30	150	39,57
21	270,5	255,65	150	30	60	13,35	160	30	100	28,01	160	40	150	42,98
22	282,5	267,73	150	30	60	14,24	160	30	100	30,59	160	40	150	47,25
23	294,5	279,80	150	30	60	15,18	160	30	100	33,29	160	40	150	51,74
24	307,0	291,88	150	30	60	16,16	160	30	100	36,13	160	40	150	56,44
25	319,0	304,00	150	30	60	17,19	160	30	100	39,09	160	40	150	61,37
26	331,0	316,08	*150	30	60	18,25	*160	30	100	42,19	*160	40	150	66,52
27	343,0	328,19	*150	30	60	19,37	*160	30	100	45,41	*160	40	150	71,88
28	355,0	340,27	*150	30	60	20,52	*160	30	100	48,77	*160	40	150	77,46
29	367,5	352,38	*150	30	60	21,72	*160	30	100	52,26				
30	379,5	364,50	*150	30	60	22,97	*160	30	100	55,88	*160	40	150	89,28
31	391,5	376,62	*150	30	60	24,25	*160	40	100	59,19				
32	403,5	388,69	*150	30	60	25,59	*160	40	100	63,07	*160	40	150	101,97
33	415,5	400,81	*150	30	60	26,96	*160	40	100	67,08				
34	428,0	412,83	*150	30	60	28,38	*160	40	100	71,21				
35	440,0	425,04	*150	30	60	29,84	*160	40	100	75,49	*160	40	150	122,64
36	452,0	437,16	*150	30	60	31,34	*160	40	100	79,89				
37	464,0	449,27	*150	30	60	32,90	*160	40	100	84,43				
38	476,5	461,39	*150	30	60	34,49	*160	40	100	89,09	*160	40	150	145,28
40	501,5	485,62	*150	30	60	37,81	*160	40	100	98,80	*160	40	150	161,46
42	525,5	509,85	*168	30	99	48,52								
45	562,0	546,20	*168	30	99	54,08	*180	40	133	132,81	*200	40	153	209,06
46	574,0	558,82	*168	30	99	56,03								
48	598,5	582,55	*168	30	99	60,04								
50	622,5	606,78	*168	30	99	64,24	*180	40	133	162,65	*200	40	153	258,81
57	707,5	691,63	*168	30	99	80,28	*180	40	133	209,91	*200	40	153	337,62
60	745,0	727,97	*168	30	99	87,82								
76	939,0	921,98	*178	40	118	140,54	*200	40	133	373,88	*220	40	155	607,76
95	1169,0	1152,33	*178	40	118	210,67								

PIGNONI PER CATENE A RULLI - DIN 8187 - ISO 606

SPROCKETS FOR ROLLER CHAINS - DIN 8187 - ISO 606

1"3/4 x 1"1/4

44,45 x 30,99 mm

Rullo 27,94 mm

28B - 1 - 2 - 3

B1	B2	B3	b1	C	r3
29,4	88,4	148	28,8	5	44

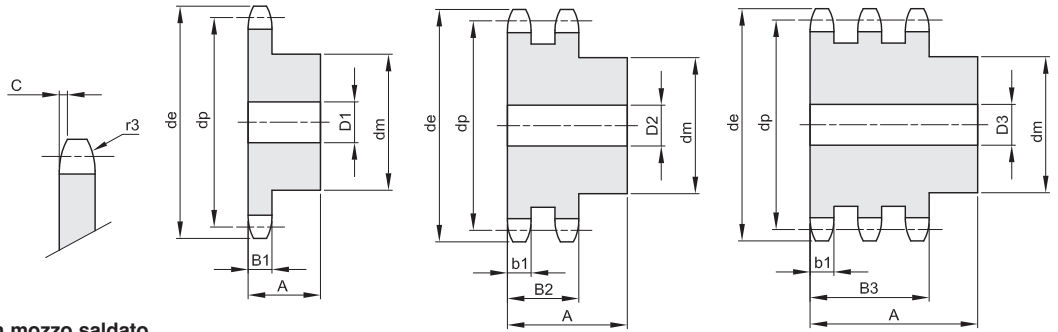

Materiale acciaio C45 / *Materiale Fe - con mozzo saldato

Z	de	dp	semplici				doppi				tripli			
			dm	D1	A	Kg.	dm	D2	A	Kg.	dm	D3	A	Kg.
8	132,0	116,15	74	25	70	2,86	74	30	120	4,75	74	30	180	7,04
9	146,0	129,96	88	25	70	4,00	88	30	120	6,66	88	30	180	9,89
10	160,0	143,85	100	25	70	5,18	100	30	120	8,79	100	30	180	13,10
11	174,0	157,77	112	25	70	6,51	112	30	120	11,19	112	30	180	16,73
12	188,0	171,74	125	25	70	8,04	125	30	120	13,91	125	30	180	20,84
13	204,0	185,75	125	25	70	8,88	125	30	120	16,25	125	30	180	24,70
14	218,0	199,76	125	25	70	9,79	125	30	120	18,81	125	30	180	28,93
15	232,0	213,79	125	25	70	10,77	145	30	120	22,64	145	30	180	34,58
16	246,0	227,84	160	30	75	14,96	160	30	120	26,52	160	30	180	40,44
17	260,0	241,90	160	30	75	16,09	160	30	120	29,74	160	30	180	45,77
18	274,0	255,98	160	30	75	17,28	160	30	120	33,17	160	30	180	51,76
19	289,0	270,06	160	30	75	18,56	180	30	120	38,14	180	30	180	58,07
20	303,0	284,15	160	30	75	19,90	180	30	120	42,02	180	30	180	64,49
21	317,0	298,24	160	30	75	21,31	180	30	120	49,10	180	40	180	71,28
22	331,0	312,34	*160	30	75	22,80	*180	30	120	50,40				
23	345,0	326,44	*160	30	75	24,36	*180	30	120	54,92	*180	40	180	85,94
24	359,0	340,55	*160	30	75	26,00								
25	373,0	354,66	*160	30	75	27,70	*180	30	120	64,62	*180	40	180	112,07
26	387,0	368,77	*160	30	75	29,48	*180	40	120	69,28				
27	401,0	382,88	*160	30	75	31,36								
28	416,0	397,00	*160	30	75	33,26	*180	40	120	80,28				
29	430,0	411,12												
30	444,0	425,24	*160	30	75	37,33	*180	40	120	92,17	*180	40	180	148,79
31	458,0	439,37												
32	472,0	453,49	*180	30	75	43,59								
33	486,0	467,62												
34	500,0	481,75	*180	30	75	48,24								
35	514,0	495,88	*180	30	75	50,57	*200	40	120	127,17				
36	529,0	510,01	*180	30	75	53,18								
37	543,0	524,13												
38	557,0	538,27	*180	30	75	58,40	*200	40	120	149,90	*200	40	180	244,01
40	585,0	566,54	*180	30	75	63,92	*200	40	120	167,15	*200	40	180	271,10
45	656,0	637,22	*180	30	75	79,12	*200	40	150	218,10	*200	40	209	352,63
50	726,0	707,91	*180	30	75	96,00	*200	40	150	267,99				
57	825,0	806,90	*180	40	123	125,13	*200	40	150	346,99	*200	40	209	567,76
60	869,0	849,32	*180	40	123	144,00								
76	1095,0	1075,62	*180	40	123	215,46	*200	40	150	615,35	*238	40	217	1024,97

PIGNONI PER CATENE A RULLI - DIN 8187 - ISO 606

SPROCKETS FOR ROLLER CHAINS - DIN 8187 - ISO 606

2" x 1"1/4

50,8 x 30,99 mm
Rullo 29,21 mm
32B - 1 - 2 - 3

B1	B2	B3	b1	C	r3
29,4	87,4	146	28,8	6	51

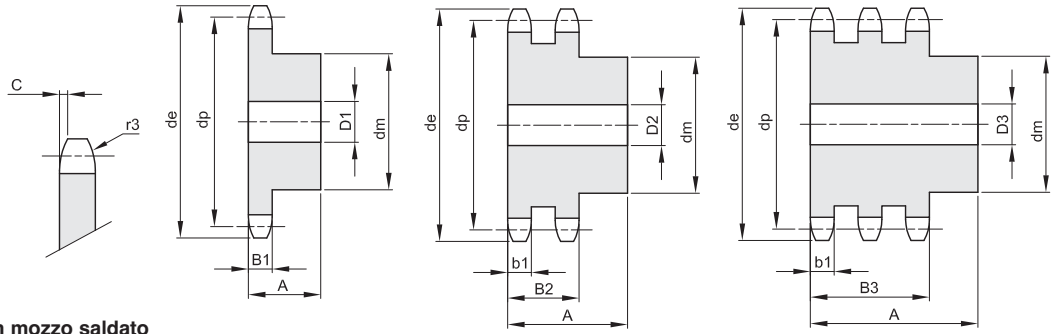

Materiale acciaio C45 / *Materiale Fe - con mozzo saldato

Z	de	dp	semplici				doppi				tripli			
			dm	D1	A	Kg.	dm	D2	A	Kg.	dm	D3	A	Kg.
8	152,0	132,74	85	30	80	4,20	85	30	120	6,65	85	30	180	9,90
9	168,0	148,54	100	30	80	5,78	100	30	120	9,14	100	30	180	13,65
10	184,0	164,39	115	30	80	7,60	115	30	120	12,01	115	30	180	17,97
11	200,0	181,31	125	30	80	9,26	125	35	120	14,75	125	35	180	22,22
12	216,0	196,29	133	30	80	10,91	133	35	120	17,95	133	35	180	27,23
13	235,0	212,29	145	30	80	13,05	145	35	120	21,68	145	35	180	32,98
14	251,0	228,29	145	30	80	14,25	145	35	120	25,03	145	35	180	38,50
15	267,0	244,30	145	30	80	15,53	160	35	120	29,30	160	35	180	45,04
16	283,0	260,40	160	30	90	19,87	160	40	120	33,21	160	40	180	51,50
17	299,0	276,46	160	30	90	21,35	180	40	120	38,76	200	40	180	61,45
18	315,0	292,55	160	30	90	22,92	180	40	120	43,24	200	40	180	68,85
19	331,0	308,66	160	30	90	24,53	200	40	120	49,52	200	40	180	76,73
20	347,0	324,71	180	40	90	28,50	200	40	120	54,56	200	40	180	85,07
21	363,0	340,82	180	40	90	30,36	200	40	120	59,87	200	40	180	93,89
22	379,0	356,98	*180	40	90	32,31	*200	40	120	65,47				
23	396,0	373,08	*180	40	90	34,36	*200	40	120	71,35	*200	40	180	112,93
24	412,0	389,18	*180	40	90	36,50	*200	40	120	77,52				
25	428,0	405,33	*180	40	90	38,74	*200	40	120	83,66	*200	40	180	133,86
26	444,0	421,44	*180	40	90	41,07	*200	40	120	90,69				
27	460,0	437,59												
28	476,0	453,69	*180	40	90	46,01	*200	40	120	104,99				
29	492,0	469,85												
30	508,0	486,00	*180	40	90	51,34	*200	40	120	120,41	*200	40	180	194,42
31	525,0	502,13												
32	541,0	518,27	*200	40	90	59,89								
33	557,0	534,42												
34	573,0	550,56												
35	589,0	566,71	*200	40	90	69,16	*200	40	120	163,85	*200	40	180	267,49
36	605,0	582,86												
37	622,0	599,01												
38	638,0	615,16	*200	40	90	79,28	*200	40	120	193,33	*200	40	180	316,22
40	670,0	647,47	*200	40	90	86,50	*200	40	120	214,39				
45	751,0	728,24	*218	40	123	118,87	*220	40	148	282,32	*220	40	207	456,64
50	832,0	809,04	*218	40	123	140,96	*220	40	148	346,95	*220	40	207	564,27
57	945,0	922,16	*218	40	123	175,86	*220	40	148	449,27	*220	40	207	734,72
60	993,0	970,65	*218	40	123	192,24								
76	1252,0	1229,27	*218	40	123	294,00	*220	40	148	796,60	*238	40	216	1319,64

PIGNONI SEMPLICI TEMPERATI AD INDUZIONE PER CATENE A RULLI - DIN 8187 - ISO 606
SIMPLEX SPROCKETS WITH HARDENED TEETH FOR ROLLER CHAINS - DIN 8187 - ISO 606

3/8" x 7/32"

9,525 x 5,72 mm
Rullo 6,35 mm
06B - 1

B1	C	r3
5,3	1	10

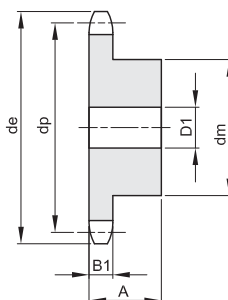
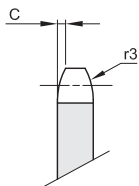

Materiale acciaio C45

Z	de	dp	dm	D1	A	Kg.
13	43,5	39,80	28	8	25	0,13
14	46,5	42,80	31	8	25	0,16
15	49,5	45,81	34	8	25	0,19
16	52,5	48,82	37	10	28	0,24
17	55,5	51,83	40	10	28	0,28
18	58,6	54,85	43	10	28	0,33
19	61,6	57,87	45	10	28	0,36
20	64,6	60,89	46	10	28	0,39
21	67,6	63,91	48	12	28	0,42
22	70,6	66,93	50	12	28	0,46
23	73,7	69,95	52	12	28	0,50
24	76,7	72,97	54	12	28	0,54
25	79,7	76,00	57	12	28	0,60
30	94,8	92,12	60	12	30	0,72

Z	de	dp	dm	D1	A	Kg.

1/2" x 5/16"

12,7 x 7,75 mm
Rullo 8,51 mm
08B - 1

B1	C	r3
7,2	1,3	1,3

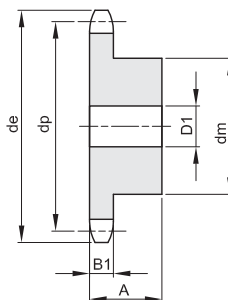
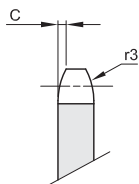

Materiale acciaio C45

Z	de	dp	dm	D1	A	Kg.
12	53,9	49,07	33	10	28	0,21
13	57,9	53,06	37	10	28	0,26
14	61,9	57,07	41	10	28	0,32
15	65,9	61,09	45	10	28	0,38
16	69,9	65,10	50	12	28	0,46
17	74,0	69,11	52	12	28	0,51
18	78,0	73,14	56	12	28	0,59
19	82,0	77,16	60	12	28	0,67
20	86,0	81,19	64	12	28	0,76
21	90,1	85,22	68	14	28	0,85
22	94,1	89,24	70	14	28	0,91
23	98,1	93,27	70	14	28	0,94
24	102,1	97,29	70	14	28	0,98
25	106,2	101,33	70	14	28	1,01
30	126,3	121,50	80	16	30	1,46

Z	de	dp	dm	D1	A	Kg.

PIGNONI SEMPLICI TEMPERATI AD INDUZIONE PER CATENE A RULLI - DIN 8187 - ISO 606
SIMPLEX SPROCKETS WITH HARDENED TEETH FOR ROLLER CHAINS - DIN 8187 - ISO 606

5/8" x 3/8"

15,875 x 9,65 mm
Rullo 10,16 mm
10B - 1

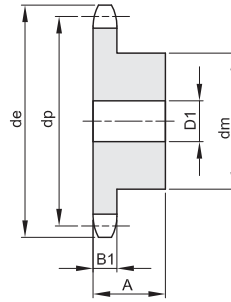
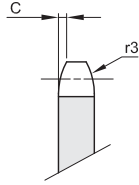

B1	C	r3
9,1	1,6	1,6

Materiale acciaio C45

Z	de	dp	dm	D1	A	Kg.
12	68,2	61,34	42	12	30	0,37
13	73,2	66,32	47	12	30	0,46
14	78,2	71,34	52	12	30	0,56
15	83,2	76,36	57	12	30	0,67
16	88,3	81,37	60	12	30	0,76
17	93,3	86,39	60	12	30	0,88
18	98,3	91,42	70	14	30	1,01
19	103,3	96,45	70	14	30	1,15
20	108,4	101,49	75	14	30	1,21
21	113,4	106,52	75	16	30	1,35
22	118,4	111,55	80	16	30	1,41
23	123,5	116,58	80	16	30	1,47
24	128,5	121,62	80	16	30	1,54
25	133,6	126,66	80	16	30	1,60
30	158,8	151,87	90	20	35	2,41

Z	de	dp	dm	D1	A	Kg.

3/4" x 7/16"

19,05 x 11,68 mm
Rullo 12,07 mm
12B - 1

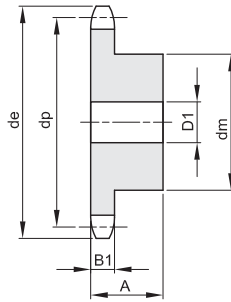
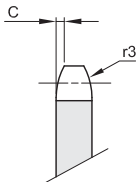

B1	C	r3
11,1	2	19

Materiale acciaio C45

Z	de	dp	dm	D1	A	Kg.
12	81,8	73,60	52	16	35	0,65
13	87,8	79,59	58	16	35	0,80
14	93,8	85,61	64	16	35	0,97
15	99,8	91,63	70	16	35	1,16
16	105,8	97,65	75	16	35	1,34
17	111,9	103,67	80	16	35	1,53
18	117,9	109,71	80	16	35	1,61
19	123,9	115,75	80	16	35	1,70
20	130,0	121,78	80	16	35	1,80
21	136,0	127,82	90	20	40	2,35
22	142,0	133,86	90	20	40	2,46
23	148,1	139,90	90	20	40	2,56
24	154,1	145,94	90	20	40	2,68
25	160,2	152,00	90	20	40	2,80
30	190,4	182,25	95	20	40	3,63

Z	de	dp	dm	D1	A	Kg.

PIGNONI SEMPLICI TEMPERATI AD INDUZIONE PER CATENE A RULLI - DIN 8187 - ISO 606
SIMPLEX SPROCKETS WITH HARDENED TEETH FOR ROLLER CHAINS - DIN 8187 - ISO 606

1" x 17,02 mm

25,4 x 17,02 mm

Rullo 15,88 mm

16B - 1

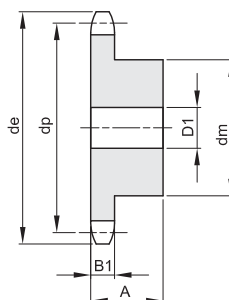
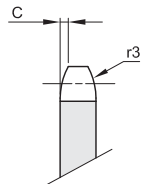

B1	C	r3
16,2	2,5	26

Materiale acciaio C45

Z	de	dp	dm	D1	A	Kg.
12	109,7	98,14	69	16	40	1,43
13	117,7	106,12	78	16	40	1,77
14	125,7	114,15	84	16	40	2,08
15	133,7	122,17	92	16	40	2,46
16	141,8	130,20	100	20	45	3,14
17	149,8	138,22	100	20	45	3,34
18	157,8	146,28	100	20	45	3,56
19	165,9	154,33	100	20	45	3,78
20	173,9	162,38	100	20	45	4,03
21	182,0	170,43	110	20	50	5,01
22	190,1	178,48	110	20	50	5,28
23	198,1	186,53	110	20	50	5,56
24	206,1	194,59	110	20	50	5,86
25	214,2	202,65	110	20	50	6,16
30	254,6	243,00	120	20	50	8,38

Z	de	dp	dm	D1	A	Kg.



PIGNONI PER BUSSOLA CONICA - DIN 8187 - ISO 606

SPROCKETS FOR TAPER BUSHES - DIN 8187 - ISO 606

3/8" x 7/32"

9,525 x 5,72 mm
Rullo 6,35 mm
06B - 1 - 2 - 3

B1	B2	B3	b1	C	r3
5,3	15,4	25,6	5,2	1	10

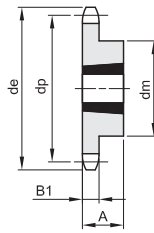
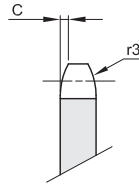

1

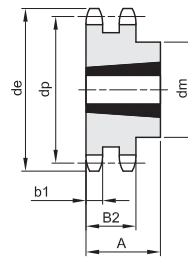

2

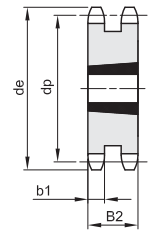

3

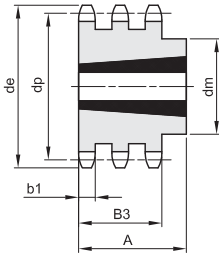

4

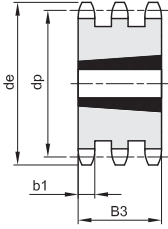

5

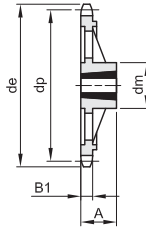

6

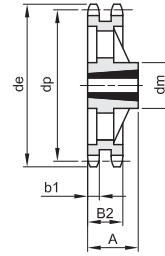

7

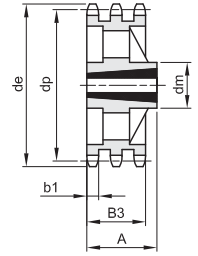

8

Materiale acciaio C45 / * Materiale Ghisa EN-GJL-200

Z	de	dp	semplici				doppi				tripli						
			dm	A	Bussola	Tipo	Kg.	dm	A	Bussola	Tipo	Kg.	dm	A	Bussola	Tipo	Kg.
17	55,5	51,83	45	22	1008	1	0,11	41	22	1008	2	0,11	25,6	1008	5	0,15	
18	58,6	54,85	45	22	1008	1	0,14	43	22	1008	2	0,15					
19	61,6	57,86	45	22	1008	1	0,15	46	22	1008	2	0,18	25,6	1008	5	0,24	
20	64,6	60,89	46	22	1008	1	0,16	48	22	1008	2	0,22					
21	67,6	63,90	46	22	1008	1	0,18	49	22	1008	2	0,16	25,6	1008	5	0,34	
22	70,6	66,93	55	22	1108	1	0,25	52	22	1108	2	0,28					
23	73,7	69,95	63	25	1210	1	0,27	59	25	1210	2	0,27	25,6	1210	5	0,30	
24	76,7	72,97	63	25	1210	1	0,30	61	25	1210	2	0,32					
25	79,7	75,99	63	25	1210	1	0,32	64	25	1210	2	0,37	25,6	1210	5	0,41	
26	82,7	79,02	63	25	1210	1	0,33	65	25	1210	2	0,44					
27	85,7	82,04	63	25	1210	1	0,34	70	25	1210	2	0,50	25,6	1210	5	0,55	
28	88,8	85,07	63	25	1210	1	0,37	70	25	1210	2	0,57					
30	94,8	91,12	63	25	1210	1	0,39	75	25	1210	2	0,68	79	38	1615	4	0,88
38	119,0	115,34	70	25	1210	1	0,65	80	25	1610	2	1,03	90	38	1615	4	1,75
45	141,1	136,54	70	25	1210	1	1,01										
57*	177,5	172,91	83	25	1210	6	1,34	92	25	1610	7	1,16					
76*	235,1	230,49	83	25	1210	6	1,84	92	25	1610	7	2,19					

PIGNONI PER BUSSOLA CONICA - DIN 8187 - ISO 606

SPROCKETS FOR TAPER BUSHES - DIN 8187 - ISO 606

1/2" x 5/16"
12,7 x 7,75 mm
Rullo 8,51 mm
08B - 1 - 2 - 3

B1	B2	B3	b1	C	r3
7,2	21	34,9	7	1,3	13

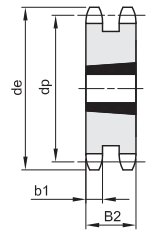
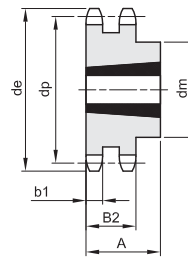
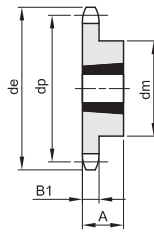
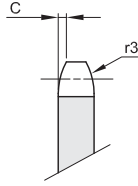

1

2

3

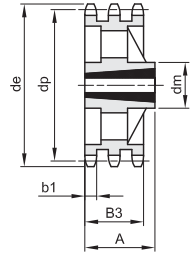
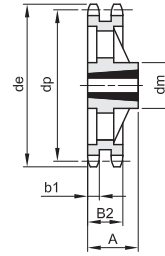
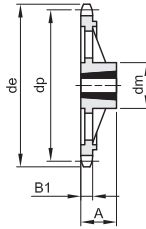
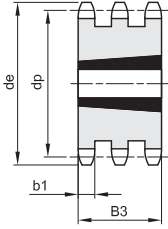
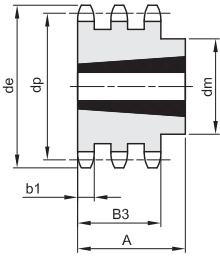

4

5

6

7

8

Materiale acciaio C45 / * Materiale Ghisa EN-GJL-200

Z	de	dp	semplici				doppi				tripli						
			dm	A	Bussola	Tipo	Kg.	dm	A	Bussola	Tipo	Kg.	dm	A	Bussola	Tipo	Kg.
15	66,5	61,80	45	22	1008	1	0,16	46	22	1008	2	0,22	34,9	1008	5	0,36	
16	69,9	65,10	50	22	1108	1	0,20	50	22	1108	2	0,22					
17	74,5	69,11	60	25	1210	1	0,22	56	25	1210	2	0,23	34,9	1210	5	0,35	
18	78,0	73,14	60	25	1210	1	0,27	60	25	1210	2	0,30					
19	82,5	77,15	63	25	1210	1	0,33	62	25	1210	2	0,38	62	38	1215	4	0,61
20	86,0	81,19	67	25	1610	1	0,27	66	25	1610	2	0,45					
21	90,6	85,21	71	25	1610	1	0,36	70	25	1610	2	0,50	70	38	1615	4	0,65
22	94,1	89,24	71	25	1610	1	0,36	76	25	1610	2	0,55					
23	98,7	93,26	76	25	1610	1	0,50	79	25	1610	2	0,62	70	38	1615	4	0,93
24	102,1	97,29	76	25	1610	1	0,53	84	32	2012	2	0,68					
25	106,7	101,32	76	25	1610	1	0,56	87	32	2012	2	0,72	34,9	2012	5	0,85	
26	110,2	105,36	76	25	1610	1	0,60	87	32	2012	2	0,82					
27	114,8	109,39	76	25	1610	1	0,63	87	32	2012	2	0,92	34,9	2012	5	1,18	
28	118,3	113,42	90	32	2012	1	0,77	87	32	2012	2	1,10					
30	126,9	121,49	90	32	2012	1	0,91	87	32	2012	2	1,24	34,9	2012	5	1,73	
38	159,2	153,79	90	32	2012	1	1,25	100	32	2012	2	2,50	34,9	2012	5	3,53	
45	188,6	182,07	111	32	2012	1	1,68										
57*	237,1	230,54	111	32	2012	6	2,78	111	32	2012	7	3,64					
76*	313,9	307,33	111	32	2012	6	3,81	111	32	2012	7	5,09					

PIGNONI PER BUSSOLA CONICA - DIN 8187 - ISO 606

SPROCKETS FOR TAPER BUSHES - DIN 8187 - ISO 606

5/8" x 3/8"

15,875 x 9,65 mm
Rullo 10,16 mm
10B - 1 - 2 - 3

B1	B2	B3	b1	C	r3
9,1	25,5	42,1	9	1,6	16

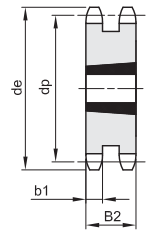
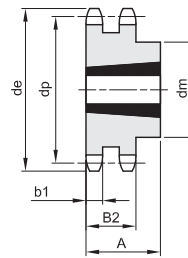
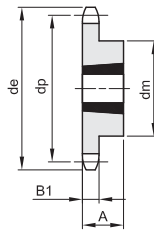
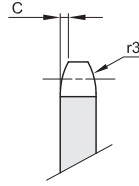

1

2

3

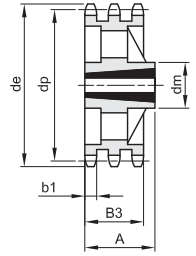
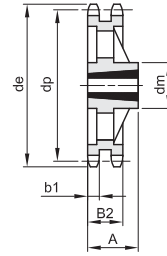
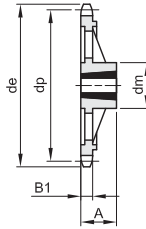
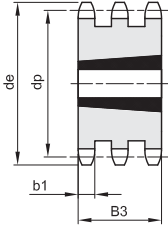
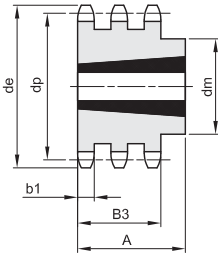

4

5

6

7

8

Materiale acciaio C45 / * Materiale Ghisa EN-GJL-200

Z	de	dp	semplici				doppi				tripli							
			dm	A	Bussola	Tipo	Kg.	dm	A	Bussola	Tipo	Kg.	dm	A	Bussola	Tipo	Kg.	
13	73,2	66,33	47	22	1008	1	0,23											
14	78,2	71,34	52	22	1108	1	0,27											
15	83,2	76,35	60	25	1210	1	0,30	25,5	1210	3	0,38	42,1	1215	5	0,63			
16	88,3	81,37	63	25	1210	1	0,38	25,5	1610	3	0,42							
17	93,3	86,39	71	25	1610	1	0,38	25,5	1610	3	0,47	42,1	1215	5	1,01			
18	98,3	91,42	71	25	1610	1	0,43	25,5	1610	3	0,60							
19	103,3	96,44	75	25	1610	1	0,54	25,5	1610	3	0,72	42,1	1615	5	1,19			
20	108,4	101,49	76	25	1610	1	0,61	25,5	1610	3	0,87							
21	113,4	106,51	76	25	1610	1	0,65	25,5	1610	3	1,01	42,1	1615	5	1,66			
22	118,4	111,55	76	25	1610	1	0,72	25,5	1610	3	1,18							
23	123,5	116,58	76	25	1610	1	0,77	25,5	1610	3	1,35	42,1	2012	5	1,78			
24	128,5	121,62	90	32	2012	1	0,98	90	32	2012	2	1,45						
25	133,6	126,66	90	32	2012	1	1,05	90	32	2012	2	1,55	105	44	2517	4	1,81	
26	138,6	131,70	90	32	2012	1	1,11	90	32	2012	2	1,75						
27	143,6	136,74	90	32	2012	1	1,17	90	32	2012	2	1,98	110	44	2517	4	2,45	
28	148,7	141,78	90	32	2012	1	1,29	90	32	2012	2	2,30						
30	158,8	151,87	90	32	2012	1	1,40	90	32	2012	2	2,63	120	44	2517	4	3,54	
38	199,1	192,23	100	32	2012	1	2,43											
45	236,0	227,58	111	32	2012	1	3,55											
57*	296,6	288,18	111	32	2012	6	4,28											
76*	392,5	384,16	111	32	2012	6	5,95											

PIGNONI PER BUSSOLA CONICA - DIN 8187 - ISO 606

SPROCKETS FOR TAPER BUSHES - DIN 8187 - ISO 606

3/4" x 7/16"

19,05 x 11,68 mm

Rullo 12,07 mm

12B - 1 - 2 - 3

B1	B2	B3	b1	C	r3
-----------	-----------	-----------	-----------	----------	-----------

11,1	30,3	49,8	10,8	2	19
------	------	------	------	---	----

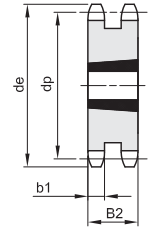
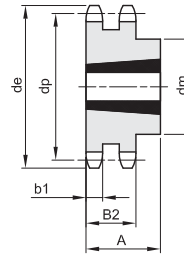
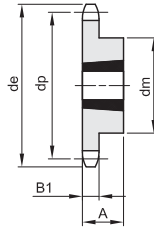
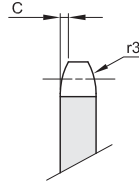

1

2

3

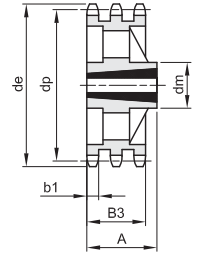
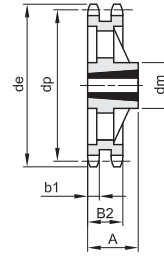
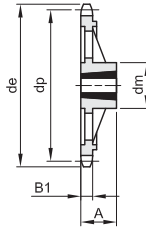
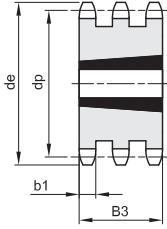
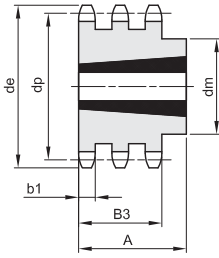

4

5

6

7

8

Materiale acciaio C45 / * Materiale Ghisa EN-GJL-200

Z	de	dp	semplici				doppi				tripli						
			dm	A	Bussola	Tipo	Kg.	dm	A	Bussola	Tipo	Kg.	dm	A	Bussola	Tipo	Kg.
13	87,8	79,60	60	25	1210	1	0,35										
14	93,8	85,61	67	25	1610	1	0,40										
15	99,8	91,62	70	25	1610	1	0,44		30,3	1610	3	0,68		49,8	1615	5	1,11
16	105,8	97,65	71	25	1610	1	0,53		30,3	1610	3	0,89					
17	111,9	103,67	76	25	1610	1	0,66		30,3	1610	3	1,14		49,8	1615	5	1,75
18	117,9	109,71	90	32	2012	1	0,86	90	32	2012	2	1,18					
19	123,9	115,73	90	32	2012	1	0,94	90	32	2012	2	1,24		49,8	2012	5	2,02
20	130,0	121,78	90	32	2012	1	1,04	108	44	2517	2	1,40					
21	136,0	127,81	102	44	2517	1	1,24	108	44	2517	2	1,68		49,8	2517	5	2,09
22	142,0	133,86	108	44	2517	1	1,60	108	44	2517	2	1,99					
23	148,1	139,90	108	44	2517	1	1,70	108	44	2517	2	2,24		49,8	2517	5	3,00
24	154,1	145,94	108	44	2517	1	1,81	108	44	2517	2	2,54					
25	160,2	151,99	108	44	2517	1	1,93	108	44	2517	2	2,87		49,8	2517	5	3,98
26	166,2	158,04	108	44	2517	1	2,04	108	44	2517	2	3,17					
27	172,3	164,09	108	44	2517	1	2,14	108	44	2517	2	3,55	140	51	3020	4	3,90
28	178,3	170,13	108	44	2517	1	2,37	108	44	2517	2	4,10					
30	190,4	182,24	108	44	2517	1	2,60	108	44	2517	2	4,62	140	51	3020	4	5,64
38	238,9	230,69	108	44	2517	1	3,93	140	51	3020	2	8,11	140	51	3020	4	11,58
45	283,2	273,10	124	44	2517	1	5,52										
57*	355,9	345,81	124	44	2517	6	6,48	160	51	3020	7	10,28	160	51	3020	8	13,23
76*	471,1	460,99	124	44	2517	6	9,71	160	51	3020	7	15,24					

PIGNONI PER BUSSOLA CONICA - DIN 8187 - ISO 606

SPROCKETS FOR TAPER BUSHES - DIN 8187 - ISO 606

1" x 17,02 mm

25,4 x 17,02 mm
Rullo 15,88 mm
16B - 1 - 2 - 3

B1 B2 B3 b1 C r3

16,2 47,7 79,6 15,8 2,5 26

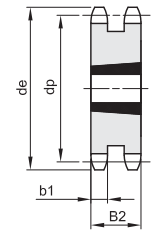
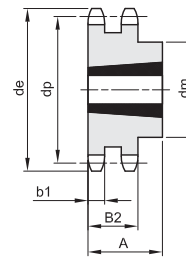
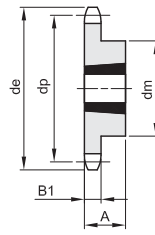
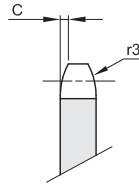

1

2

3

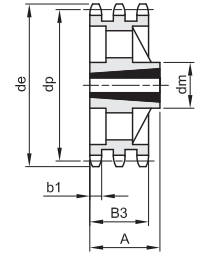
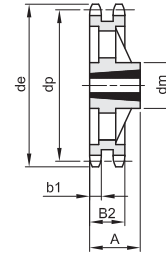
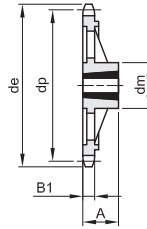
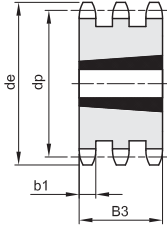
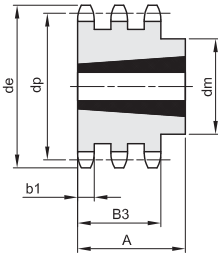

4

5

6

7

8

Materiale acciaio C45 / * Materiale Ghisa EN-GJL-200

Z	de	dp	semplici				doppi				tripli							
			dm	A	Bussola	Tipo	Kg.	dm	A	Bussola	Tipo	Kg.	dm	A	Bussola	Tipo	Kg.	
13	117,7	106,13	73	38	1615	1	0,98											
14	125,7	114,15	75	38	1615	1	1,14											
15	133,7	122,16	76	38	1615	1	1,30		47,7	2012	3	2,11						
16	141,8	130,20	90	32	2012	1	1,40		47,7	2517	3	2,25						
17	149,8	138,23	90	32	2012	1	1,59		47,7	2517	3	2,53		79,6	2517	5	4,29	
18	157,8	146,28	108	44	2517	1	2,10		47,7	2517	3	3,10						
19	165,9	154,31	108	44	2517	1	2,29		47,7	2517	3	3,80		79,6	3030	5	4,36	
20	173,9	162,38	110	44	2517	1	2,60		47,7	2517	3	4,10						
21	182,0	170,42	110	44	2517	1	2,81	140	51	3020	2	4,15		79,6	3030	5	6,69	
22	190,1	178,48	110	44	2517	1	3,10	140	51	3020	2	4,90						
23	198,1	186,53	110	44	2517	1	3,38	140	51	3020	2	5,69	159	89	3535	4	7,80	
24	206,2	194,59	110	44	2517	1	3,70	140	51	3020	2	6,00						
25	214,2	202,66	110	44	2517	1	3,97	140	51	3020	2	6,38	175	89	3535	4	10,93	
26	222,3	210,72	110	44	2517	1	4,26	140	51	3020	2	7,80						
27	230,4	218,79	110	44	2517	1	4,55	140	51	3020	2	9,27	175	89	3535	4	14,06	
28	238,4	226,85	110	44	2517	1	5,26	140	51	3020	2	11,40						
30	254,6	242,99	120	44	2517	1	5,97	140	76	3030	2	13,50	175	89	3535	4	19,10	
38	319,2	307,59	160	51	3020	1	8,73	*160	76	3030	7	14,94	*178	89	3535	8	21,65	
45	377,9	364,12	160	51	3020	1	12,49											
57*	474,9	461,07	160	51	3020	6	13,87	178	89	3535	7	25,62	216	102	4040	8	40,50	
76*	628,4	614,65	160	51	3020	6	22,63											

PIGNONI PER BUSSOLA CONICA - DIN 8187 - ISO 606

SPROCKETS FOR TAPER BUSHES - DIN 8187 - ISO 606

1"1/4 x 3/4"

31,75 x 19,56 mm
Rullo 19,05 mm
20B - 1

B1	B2	B3	b1	C	r3
18,5				3,5	32

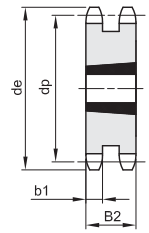
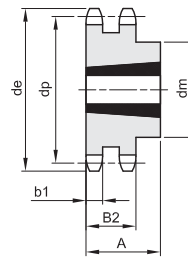
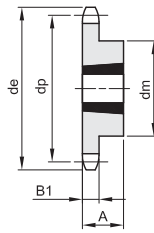
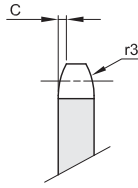

1

2

3

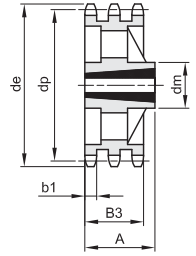
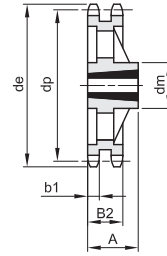
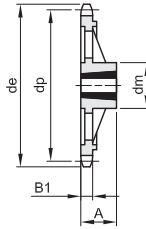
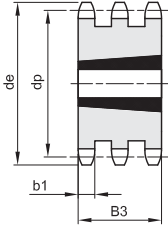
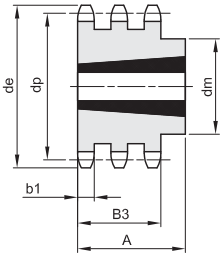

4

5

6

7

8

Materiale acciaio C45 / * Materiale Ghisa EN-GJL-200

Z	de	dp	semplici				doppi				tripli							
			dm	A	Bussola	Tipo	Kg.	dm	A	Bussola	Tipo	Kg.	dm	A	Bussola	Tipo	Kg.	
15	167,7	152,72	110	44	2517	1	3,39											
17	187,7	172,78	110	44	2517	1	5,07											
19	207,9	192,91	110	44	2517	1	6,75											
21	228,0	213,04	120	44	2517	1	7,70											
23	248,2	233,17	120	44	2517	1	8,78											
25	268,4	253,33	120	44	2517	1	9,50											
30	318,7	303,65	160	51	3020	1	11,90											
38*	399,4	384,49	160	51	3020	6	15,80											

PIGNONI PER BUSSOLA CONICA TEMPERATI AD INDUZIONE - DIN 8187 - ISO 606
SPROCKETS FOR TAPER BUSHES WITH HARDENED TEETH - DIN 8187 - ISO 606

3/8" x 7/32"

9,525 x 5,72 mm
Rullo 6,35 mm
06B - 1

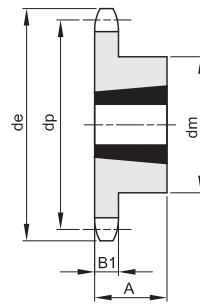
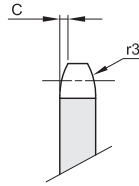

B1	C	r3
5,3	1	10

5,3	1	10
-----	---	----

Materiale acciaio C45

Z	de	dp	dm	A	semplici bussola	Kg.
17	55,5	51,83	45	22	1008	0,11
19	61,6	57,86	45	22	1008	0,15
21	67,6	63,90	46	22	1008	0,18
23	73,7	69,95	63	25	1210	0,27
25	79,7	75,99	63	25	1210	0,32

Z	de	dp	dm	A	semplici bussola	Kg.
27	85,7	82,04	63	25	1210	0,34
30	94,8	91,12	63	25	1210	0,39

1/2" x 5/16"

12,7 x 7,75 mm
Rullo 8,51 mm
08B - 1

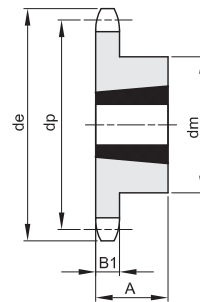
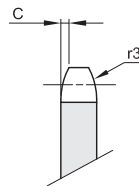

B1	C	r3
7,2	1,3	13

7,2	1,3	13
-----	-----	----

Materiale acciaio C45

Z	de	dp	dm	A	semplici bussola	Kg.
15	66,5	61,80	45	22	1008	0,16
17	74,5	69,11	60	25	1210	0,22
19	82,5	77,15	63	25	1210	0,33
21	90,6	85,21	71	25	1610	0,36
23	98,7	93,26	76	25	1610	0,50

Z	de	dp	dm	A	semplici bussola	Kg.
25	106,7	101,32	76	25	1610	0,56
27	114,8	109,39	76	25	1610	0,63
30	126,9	121,49	90	32	2012	0,91

5/8" x 3/8"

15,875 x 9,65 mm
Rullo 10,16 mm
10B - 1

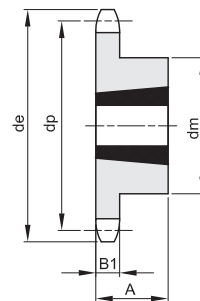
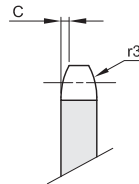

B1	C	r3
9,1	1,6	16

9,1	1,6	16
-----	-----	----

Materiale acciaio C45

Z	de	dp	dm	A	semplici bussola	Kg.
13	73,2	66,33	47	22	1008	0,23
15	83,2	76,35	60	25	1210	0,30
17	93,3	86,39	71	25	1610	0,38
19	103,3	96,44	75	25	1610	0,54
21	113,4	106,51	76	25	1610	0,65

Z	de	dp	dm	A	semplici bussola	Kg.
23	123,5	116,58	76	25	1610	0,77
25	133,6	126,66	90	32	2012	1,05
27	143,6	136,74	90	32	2012	1,17
30	158,8	151,87	90	32	2012	1,40

PIGNONI PER BUSSOLA CONICA TEMPERATI AD INDUZIONE - DIN 8187 - ISO 606
SPROCKETS FOR TAPER BUSHES WITH HARDENED TEETH - DIN 8187 - ISO 606

3/4" x 7/16"

19,05 x 11,68 mm
Rullo 12,07 mm
12B - 1

B1	C	r3
11,1	2	19

Materiale acciaio C45

Z	de	dp	dm	semplici bussola		
				A		Kg.
13	87,8	79,60	60	25	1210	0,35
15	99,8	91,62	70	25	1610	0,44
17	111,9	103,67	76	25	1610	0,66
19	123,9	115,73	90	32	2012	0,94
21	136,0	127,81	102	44	2517	1,24

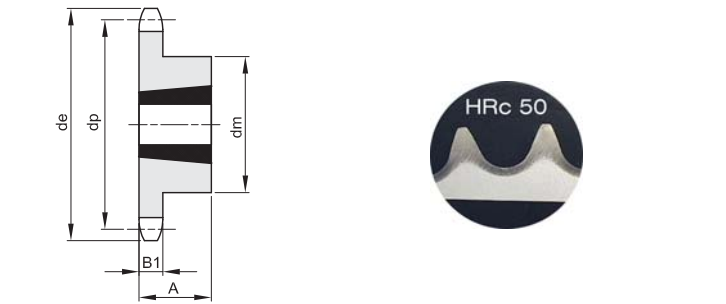

1" x 17,02 mm

25,4 x 17,02 mm
Rullo 15,88 mm
16B - 1

B1	C	r3
16,2	2,5	26

Materiale acciaio C45

Z	de	dp	dm	semplici bussola		
				A		Kg.
15	133,7	122,16	76	38	1615	1,30
17	149,8	138,23	90	32	2012	1,59
19	165,9	154,31	108	44	2517	2,29
21	182,0	170,42	110	44	2517	2,81
23	198,1	186,53	110	44	2517	3,38

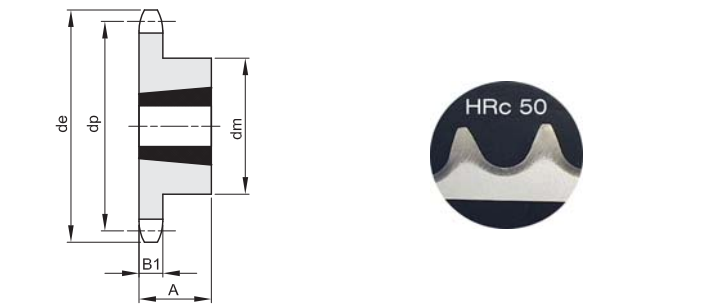

1"1/4 x 3/4"

31,75 x 19,56 mm
Rullo 19,05 mm
20B - 1

B1	C	r3
18,5	3,5	32

Materiale acciaio C45

Z	de	dp	dm	semplici bussola		
				A		Kg.
15	167,7	152,72	110	44	2517	3,39
17	187,7	172,78	110	44	2517	5,07
19	207,9	192,91	110	44	2517	6,75
21	228,0	213,04	120	44	2517	7,70
23	248,2	233,17	120	44	2517	8,78

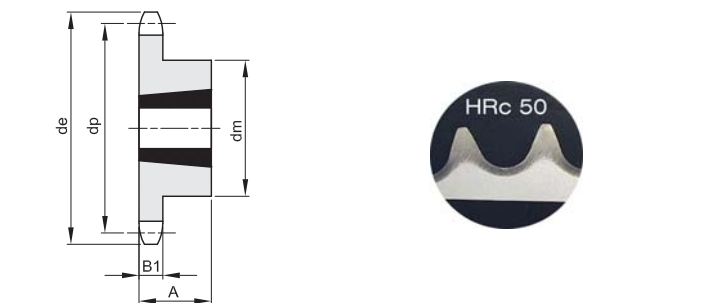

Z	de	dp	dm	semplici bussola		
				A		Kg.
25	268,4	253,33	120	44	2517	9,50

PIGNONI SEMPLICI PER CATENE A RULLI IN ACCIAIO INOX - DIN 8187 - ISO 606
SIMPLEX SPROCKETS IN STAINLESS STEEL FOR ROLLER CHAINS - DIN 8187 - ISO 606

3/8" x 7/32"

9,525 x 5,72 mm
Rullo 6,35 mm
06B - 1

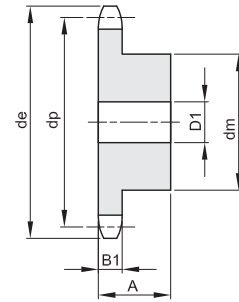
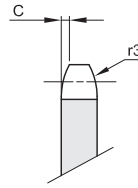

B1	C	r3
5,3	1	10

Materiale INOX AISI 304 L

Z	de	dp	dm	D1	A	Kg.
13	43,5	39,80	28	8	25	0,13
14	46,5	42,80	31	8	25	0,16
15	49,5	45,81	34	8	25	0,18
16	52,5	48,82	37	10	28	0,24
17	55,5	51,83	40	10	28	0,28
18	58,6	54,85	43	10	28	0,33
19	61,6	57,87	45	10	28	0,36

Z	de	dp	dm	D1	A	Kg.
20	64,6	60,89	46	10	28	0,39
21	67,6	63,91	48	12	28	0,42
23	73,7	69,95	52	12	28	0,50
25	79,7	76,00	57	12	28	0,60
30	94,8	91,12	60	12	30	0,72

1/2" x 5/16"

12,7 x 7,75 mm
Rullo 8,51 mm
08B - 1

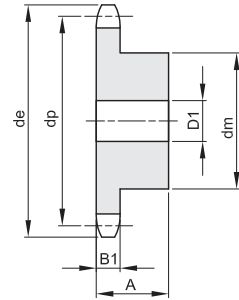
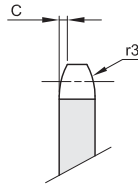

B1	C	r3
7,2	1,3	13

Materiale INOX AISI 304 L

Z	de	dp	dm	D1	A	Kg.
12	53,9	49,07	33	10	28	0,21
13	57,9	53,06	37	10	28	0,26
14	61,9	57,07	41	10	28	0,32
15	65,9	61,09	45	10	28	0,38
16	69,9	65,10	50	12	28	0,46
17	74,0	69,11	52	12	28	0,51
18	78,0	73,14	56	12	28	0,59

Z	de	dp	dm	D1	A	Kg.
19	82,0	77,16	60	12	28	0,67
20	86,0	81,19	64	12	28	0,76
21	90,1	85,22	68	14	28	0,85
23	98,1	93,27	70	14	28	0,94
25	106,2	101,33	70	14	28	1,01
30	126,3	121,50	80	16	30	1,46

5/8" x 3/8"

15,875 x 9,65 mm
Rullo 10,16 mm
10B - 1

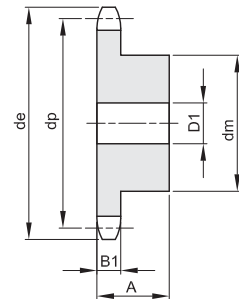
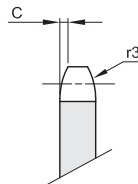

B1	C	r3
9,1	1,6	16

Materiale INOX AISI 304 L

Z	de	dp	dm	D1	A	Kg.
13	73,2	66,32	47	12	30	0,46
14	78,2	71,34	52	12	30	0,56
15	83,2	76,36	57	12	30	0,67
16	88,3	81,37	60	12	30	0,76
17	93,3	86,39	60	12	30	0,88
18	98,3	91,42	70	14	30	1,01
19	103,3	96,45	70	14	30	1,15

Z	de	dp	dm	D1	A	Kg.
20	108,4	101,49	75	14	30	1,21
21	113,4	106,52	75	16	30	1,35
23	123,5	116,58	80	16	30	1,47
25	133,6	126,66	80	16	30	1,60
30	158,8	151,87	90	20	35	2,41

PIGNONI SEMPLICI PER CATENE A RULLI IN ACCIAIO INOX - DIN 8187 - ISO 606
SIMPLEX SPROCKETS IN STAINLESS STEEL FOR ROLLER CHAINS - DIN 8187 - ISO 606

3/4" x 7/16"

19,05 x 11,68 mm
Rullo 12,07 mm
12B - 1

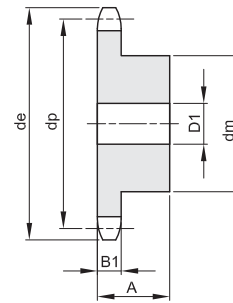
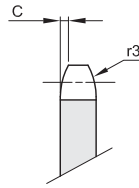

B1	C	r3
11,1	2	19

Materiale INOX AISI 304 L

Z	de	dp	dm	D1	A	Kg.
13	87,8	79,59	58	16	35	0,80
14	93,8	85,61	64	16	35	0,97
15	99,8	91,63	70	16	35	1,16
16	105,8	97,65	75	16	35	1,34
17	111,9	103,67	80	16	35	1,53
18	117,9	109,71	80	16	35	1,62
19	123,9	115,75	80	16	35	1,70

Z	de	dp	dm	D1	A	Kg.
20	130,0	121,78	80	16	35	1,80
21	136,0	127,82	90	20	40	2,35
23	148,1	139,90	90	20	40	2,56
25	160,2	152,00	90	20	40	2,80

1" x 17,02 mm

25,4 x 17,02 mm
Rullo 15,88 mm
16B - 1

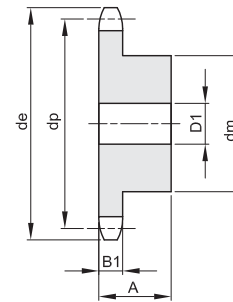
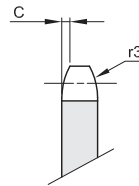

B1	C	r3
16,2	2,5	26

Materiale INOX AISI 304 L

Z	de	dp	dm	D1	A	Kg.
13	117,7	106,12	78	16	40	1,77
14	125,7	114,15	84	16	40	2,08
15	133,7	122,17	92	16	40	2,46
16	141,8	130,20	100	20	45	3,14
17	149,8	138,22	100	20	45	3,34
18	157,8	146,28	100	20	45	3,56
19	165,9	154,33	100	20	45	3,78

Z	de	dp	dm	D1	A	Kg.
20	173,9	162,38	100	20	45	4,03
21	182,0	170,43	110	20	50	5,14

PIGNONI IN GHISA PER CATENE A RULLI - DIN 8187 - ISO 606

CAST IRON SPROCKETS FOR ROLLER CHAINS - DIN 8187 - ISO 606

3/8" x 7/32"

9,525 x 5,72 mm
Rullo 6,35 mm
06B - 1 - 2 - 3

B1	B2	B3	b1	C	r3
5,3	15,4	25,6	5,2	1	10

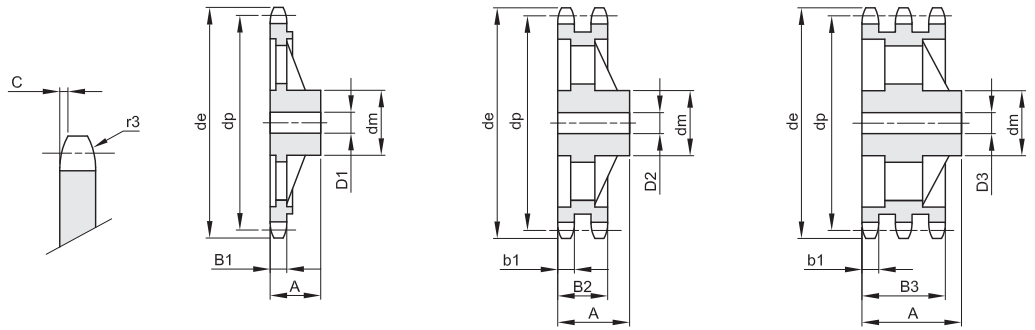

Materiale Ghisa EN-GJL-200

Z	de	dp	semplici				doppi				tripli				
			dm	D1	A	Kg.	dm	D2	A	Kg.	dm	D3	A	Kg.	
38	119,0	115,34	70	20	32	1,12									
45	141,1	136,54	70	20	32	1,30	80	20	40	2,06	90	24	56	3,56	
57	177,5	172,91	70	20	32	1,55	80	20	40	2,30	90	24	56	3,97	
76	235,1	230,49	70	20	35	2,00	80	20	40	3,02	100	24	56	4,52	
95	292,7	288,08	80	20	40	3,83	90	20	45	4,68	100	24	56	6,12	
114	350,3	345,68	80	20	40	4,05	95	20	45	5,90	100	24	56	7,45	

1/2" x 5/16"

12,7 x 7,75 mm
Rullo 8,51 mm
08B - 1 - 2 - 3

B1	B2	B3	b1	C	r3
7,2	21	34,9	7	1,3	13

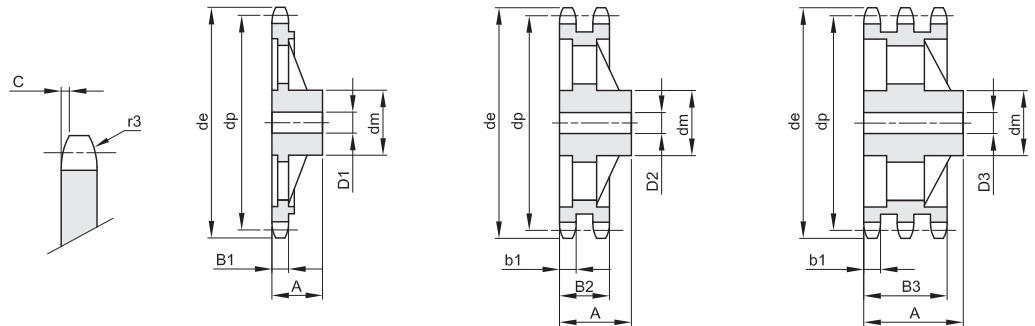

Materiale Ghisa EN-GJL-200

Z	de	dp	semplici				doppi				tripli				
			dm	D1	A	Kg.	dm	D2	A	Kg.	dm	D3	A	Kg.	
38	158,6	153,80	70	24	40	1,56	90	24	50	3,15	100	24	60	4,45	
45	188,6	182,07	70	24	40	1,95	90	24	50	3,56	100	24	60	5,85	
57	237,1	230,54	70	24	40	2,46	90	24	50	4,00	100	24	60	6,28	
76	313,9	307,33	80	24	40	4,20	100	24	56	6,35	100	24	60	8,60	
95	390,7	384,11	80	24	45	5,45	100	24	56	8,00	120	24	67	11,90	
114	467,4	460,90	80	24	45	8,35	100	24	63	11,90					

PIGNONI IN GHISA PER CATENE A RULLI - DIN 8187 - ISO 606

CAST IRON SPROCKETS FOR ROLLER CHAINS - DIN 8187 - ISO 606

5/8" x 3/8"

15,875 x 9,65 mm
Rullo 10,16 mm
10B - 1 - 2 - 3

B1	B2	B3	b1	C	r3
9,1	25,5	42,1	9	1,6	16

Materiale Ghisa EN-GJL-200

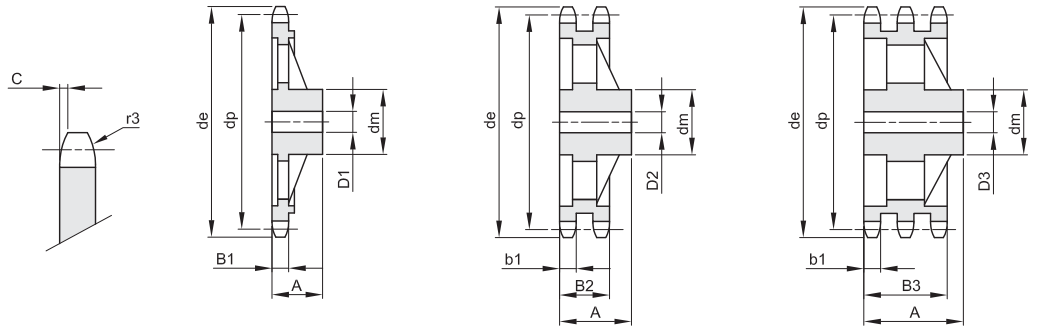

Z	de	dp	semplici				doppi				tripli			
			dm	D1	A	Kg.	dm	D2	A	Kg.	dm	D3	A	Kg.
38	199,1	192,24	80	24	40	2,32	100	30	50	4,56	100	32	60	6,50
45	236,0	227,58	80	24	40	2,88	100	30	50	4,93	100	32	60	7,04
57	296,6	288,18	90	24	45	4,30	100	30	56	6,50	100	32	63	8,00
76	392,5	384,16	90	24	50	7,00	100	30	63	9,10	110	35	67	12,00
95	488,5	480,14	100	24	56	10,65	110	30	63	12,60	125	35	70	19,40
114	584,5	576,13	100	24	56	14,50	125	30	70	17,80	125	35	80	24,00

3/4" x 7/16"

19,05 x 11,68 mm
Rullo 12,07 mm
12B - 1 - 2 - 3

B1	B2	B3	b1	C	r3
11,1	30,3	49,8	10,8	2	19

Materiale Ghisa EN-GJL-200

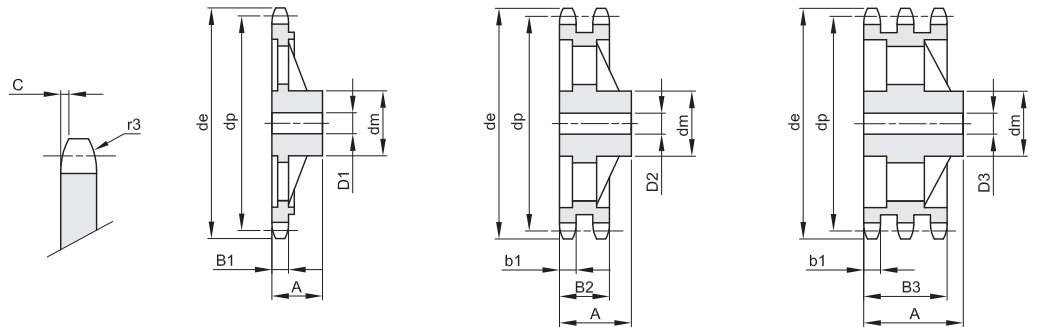

Z	de	dp	semplici				doppi				tripli			
			dm	D1	A	Kg.	dm	D2	A	Kg.	dm	D3	A	Kg.
38	238,9	230,69	100	24	56	4,75	110	25	63	7,50	115	30	70	10,00
45	283,2	273,10	100	24	56	5,90	110	30	63	8,30	140	30	70	13,30
57	355,9	345,81	100	30	56	6,45	120	30	63	10,30	140	40	70	15,25
76	471,1	460,99	100	30	56	12,30	135	30	63	15,20	160	40	75	27,20
95	586,2	576,17	100	30	65	15,40	135	30	70	20,20	170	40	82	36,40
114	701,4	691,36	100	30	65	24,80	135	45	70	30,40	170	50	82	41,10

PIGNONI IN GHISA PER CATENE A RULLI - DIN 8187 - ISO 606

CAST IRON SPROCKETS FOR ROLLER CHAINS - DIN 8187 - ISO 606

1" x 17,02 mm

25,4 x 17,02 mm
Rullo 15,88 mm
16B - 1 - 2 - 3

B1	B2	B3	b1	C	r3
16,2	47,7	79,6	15,8	2,5	26

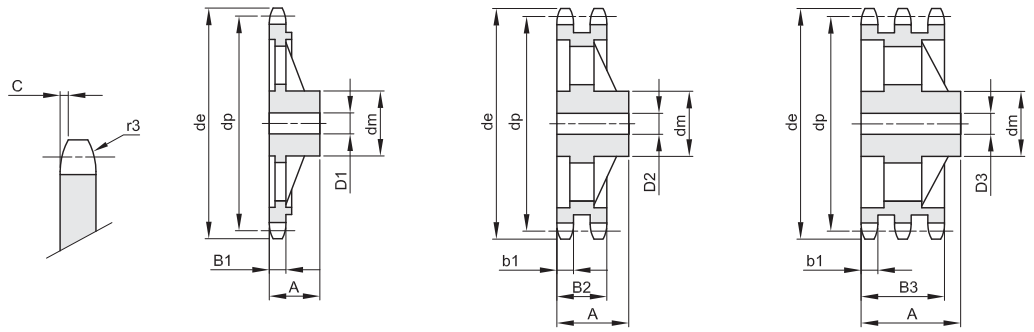

Materiale Ghisa EN-GJL-200

Z	de	dp	semplici				doppi				tripli			
			dm	D1	A	Kg.	dm	D2	A	Kg.	dm	D3	A	Kg.
38	319,2	307,59	110	30	65	8,26	140	40	75	16,45	160	45	100	25,40
45	377,9	364,12	125	30	70	10,75	150	40	75	19,20	160	45	100	33,60
57	474,9	461,07	125	35	70	12,90	170	40	90	29,50	180	45	100	44,70
76	628,4	614,65	140	35	80	24,70	175	40	95	46,30	200	45	110	63,10
95	782,0	768,22	140	40	80	32,00	175	45	95	53,00	200	50	110	77,00
114	935,6	921,81	150	40	80	45,50	180	45	95	74,00	200	50	115	97,00

1"1/4 x 3/4"

31,75 x 19,56 mm
Rullo 19,05 mm
20B - 1 - 2 - 3

B1	B2	B3	b1	C	r3
18,5	54,6	91	18,2	3,5	32

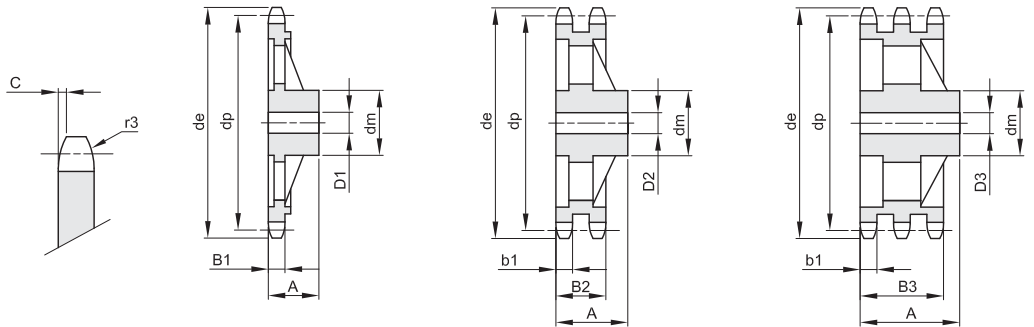

Materiale Ghisa EN-GJL-200

Z	de	dp	semplici				doppi				tripli			
			dm	D1	A	Kg.	dm	D2	A	Kg.	dm	D3	A	Kg.
38	399,4	384,49	125	35	70	12,30	140	45	90	24,80	180	50	115	52,00
57	592,3	576,36	135	40	80	25,60	170	50	100	43,00	180	50	130	71,50
76	784,3	768,32	140	50	90	29,10	180	50	110	62,50	200	50	140	115,00

PIGNONI IN GHISA PER CATENE A RULLI - DIN 8187 - ISO 606

CAST IRON SPROCKETS FOR ROLLER CHAINS - DIN 8187 - ISO 606

1"1/2 x 1"

38,1 x 25,4 mm

Rullo 25,4 mm

24B - 1 - 2 - 3

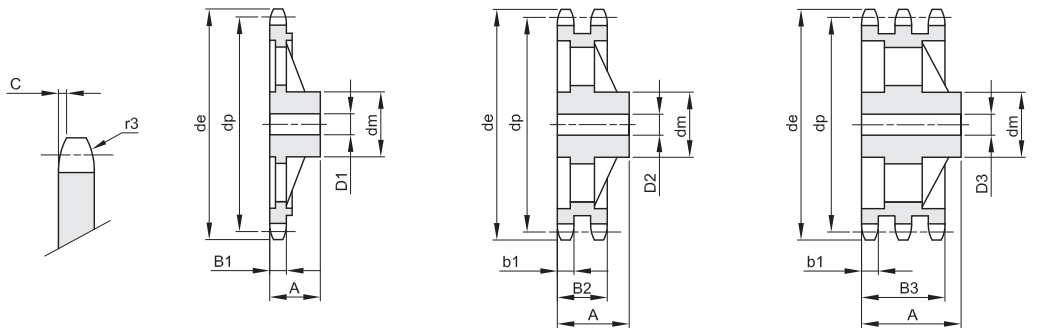

B1	B2	B3	b1	C	r3
----	----	----	----	---	----

24,1	72	120,3	23,6	4	38
------	----	-------	------	---	----

Materiale Ghisa EN-GJL-200

Z	de	dp	semplici				doppi				tripli			
			dm	D1	A	Kg.	dm	D2	A	Kg.	dm	D3	A	Kg.
38	476,5	461,39	140	45	90	21,80	180	45	100	42,20	200	50	150	42,50
57	707,5	691,63	160	45	100	46,20	200	50	110	72,70	200	55	150	119,40
76	939,0	921,98	180	45	100	63,60	220	55	120	125,00				

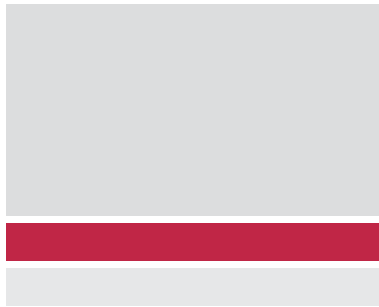

PIGNONI PER CATENE A RULLI - DIN 8188 - ISO 606 - ANSI B 29.1

SPROCKETS FOR ROLLER CHAINS - DIN 8188 - ISO 606 - ANSI B 29.1

ASA 25

6,35 x 3,18 mm
Rullo 3,3 mm
04C - 1

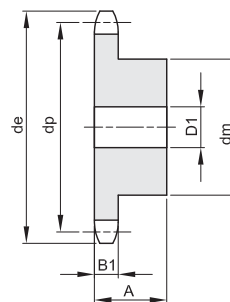
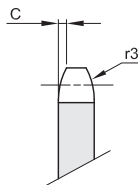

B1	B2	B3	b1	C	r3
2,9				0,6	6

Materiale acciaio C45

Z	de	dp	semplici				doppi				tripli					
			dm	D1	A	Kg.	dm	D2	A	Kg.	dm	D3	A	Kg.		
8	18,1	16,59														
9	20,2	18,56														
10	22,3	20,55	12	6	15	0,02										
11	24,3	22,54	14	6	15	0,02										
12	26,4	24,53	16	6	15	0,03										
13	28,5	26,53	18	6	15	0,03										
14	30,5	28,53	20	6	15	0,04										
15	32,5	30,55	22	6	15	0,05										
16	34,5	32,55	24	8	15	0,06										
17	36,5	34,55	26	8	15	0,07										
18	38,5	36,56	28	8	15	0,08										
19	40,5	38,58	30	8	15	0,09										
20	42,5	40,58	32	8	15	0,10										
21	44,6	42,60	34	8	15	0,11										
22	46,6	44,62	36	8	15	0,12										
23	48,6	46,63	38	8	15	0,14										
24	50,6	48,64	40	8	18	0,18										
25	52,6	50,66	42	8	18	0,20										
26	54,6	52,67														
27	56,6	54,69	46	10	18	0,22										
28	58,7	56,71	48	10	18	0,25										
29	60,7	58,73														
30	62,7	60,75	48	10	18	0,27										
31	64,7	62,76														
32	66,7	64,78	50	12	18	0,29										
33	68,8	66,80														
34	70,8	68,82	50	12	18	0,28										
35	72,8	70,84	50	12	18	0,30										
36	74,8	72,85	50	12	18	0,31										
37	76,8	74,87														
38	78,8	76,89														
39	80,9	78,91														
40	82,9	80,93														

PIGNONI PER CATENE A RULLI - DIN 8188 - ISO 606 - ANSI B 29.1
SPROCKETS FOR ROLLER CHAINS - DIN 8188 - ISO 606 - ANSI B 29.1

ASA 35

9,525 x 4,77 mm
Rullo 5,08 mm
06C - 1 - 2

B1	B2	B3	b1	C	r3
4,3	14,3		4,1	1,2	10

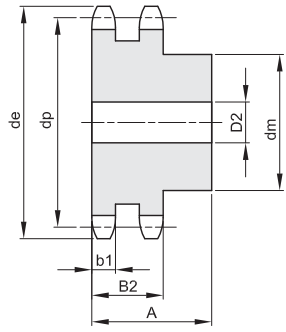
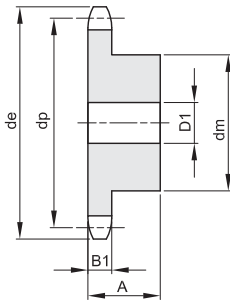
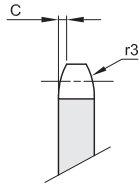

Materiale acciaio C45

Z	de	dp	semplici				doppi				tripli				
			dm	D1	A	Kg.	dm	D2	A	Kg.	dm	D3	A	Kg.	
8	28,6	24,89													
9	31,5	27,85	18	8	20	0,05									
10	34,5	30,82	20	8	20	0,05									
11	37,5	33,80	22	8	25	0,08									
12	40,5	36,80	25	8	25	0,10									
13	43,5	39,80	28	8	25	0,12	28	10	30	0,16					
14	46,5	42,80	31	8	25	0,15	31	10	30	0,19					
15	49,5	45,81	34	8	25	0,19	34	10	30	0,23					
16	52,5	48,82	37	10	28	0,24	37	12	30	0,27					
17	55,5	51,83	40	10	28	0,28	40	12	30	0,31					
18	58,6	54,85	43	10	28	0,32	43	12	30	0,36					
19	61,6	57,87	45	10	28	0,36	46	12	30	0,42					
20	64,6	60,89	46	10	28	0,38									
21	67,6	63,91	48	12	28	0,41	52	16	30	0,51					
22	70,6	66,93	50	12	28	0,45	55	16	30	0,57					
23	73,7	69,95	52	12	28	0,49	58	16	30	0,64					
24	76,7	72,97	54	12	28	0,54	61	16	30	0,71					
25	79,7	76,00	57	12	28	0,60	64	16	30	0,78					
26	82,7	79,02													
27	85,7	82,04	60	12	28	0,67	70	16	30	0,94					
28	88,8	85,07	60	12	28	0,68	73	16	30	1,02					
29	91,8	88,09	60	12	28	0,70									
30	94,8	91,12	60	12	30	0,72									
31	97,9	94,15													
32	100,9	97,17	65	14	30	0,86	80	16	30	1,31					
33	103,9	100,20													
34	106,9	103,23	65	14	30	0,92	80	16	30	1,42					
35	110,0	106,26	65	14	30	0,94	80	16	30	1,48					
36	113,0	109,29	70	16	30	1,05	90	16	30	1,69					
37	116,0	112,32	70	16	30	1,09									
38	119,0	115,34	70	16	30	1,08									
39	122,1	118,37													
40	125,1	121,40	70	16	30	1,10	90	16	30	1,90					

PIGNONI PER CATENE A RULLI - DIN 8188 - ISO 606 - ANSI B 29.1

SPROCKETS FOR ROLLER CHAINS - DIN 8188 - ISO 606 - ANSI B 29.1

ASA 40
12,7 x 7,95 mm
Rullo 7,95 mm
08A - 1 - 2

B1	B2	B3	b1	C	r3
7,2	21,4		7	1,6	13,5

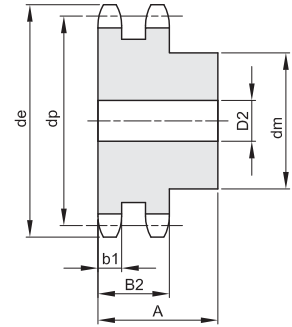
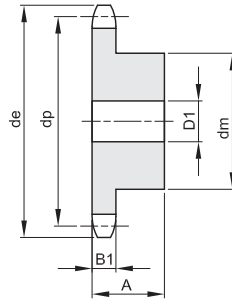
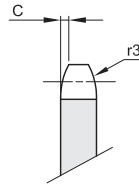

Materiale acciaio C45

Z	de	dp	semplici				doppi				tripli				
			dm	D1	A	Kg.	dm	D2	A	Kg.	dm	D3	A	Kg.	
8	39,3	33,18													
9	43,2	37,13	24	10	25	0,09									
10	47,2	41,10	26	10	25	0,12	28	10	32	0,19					
11	51,2	45,07	29	10	25	0,14									
12	55,2	49,07	33	10	28	0,20	35	12	35	0,29					
13	59,2	53,06	37	10	28	0,26	38	12	35	0,35					
14	63,2	57,07	41	10	28	0,32	42	12	35	0,43					
15	67,2	61,09	45	10	28	0,38	46	12	35	0,52					
16	71,2	65,10	50	12	28	0,45	50	16	38	0,62					
17	75,2	69,11	52	12	28	0,50	54	16	38	0,73					
18	79,2	73,14	56	12	28	0,58									
19	83,3	77,16	60	12	28	0,67	62	16	38	0,97					
20	87,3	81,19	64	12	28	0,77									
21	91,3	85,22	68	14	28	0,84	70	16	40	1,28					
22	95,4	89,24	70	14	28	0,91	70	16	40	1,37					
23	99,4	93,27	70	14	28	0,94	70	16	40	1,46					
24	103,4	97,29	70	14	28	0,97	75	16	40	1,63					
25	107,4	101,33	70	14	28	1,01	80	16	40	1,82					
26	111,5	105,36	70	16	30	1,09	85	16	40	2,01					
27	115,5	109,40	70	16	30	1,13	85	16	40	2,12					
28	119,5	113,42	70	16	30	1,16	90	16	40	2,33					
29	123,6	117,46	80	16	30	1,41									
30	127,6	121,50	80	16	30	1,46	100	16	40	2,79					
31	131,6	125,54													
32	135,7	129,56	90	16	30	1,78									
33	139,7	133,60													
34	143,8	137,64	90	16	30	1,87									
35	147,8	141,68	90	16	30	1,92	100	16	40	3,40					
36	151,8	145,72	90	16	35	2,21									
37	155,9	149,76													
38	159,9	153,80	90	16	35	2,32									
39	163,9	157,83	90	16	35	2,37									
40	168,0	161,87	90	16	35	2,43									

PIGNONI PER CATENE A RULLI - DIN 8188 - ISO 606 - ANSI B 29.1
SPROCKETS FOR ROLLER CHAINS - DIN 8188 - ISO 606 - ANSI B 29.1

ASA 50

15,875 x 9,53 mm
Rullo 10,16 mm
10A - 1 - 2

B1	B2	B3	b1	C	r3
8,7	26,5		8,4	2	17

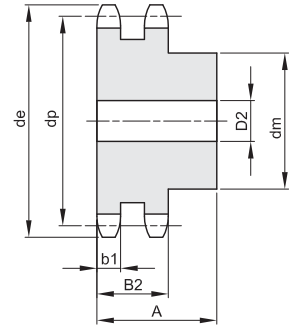
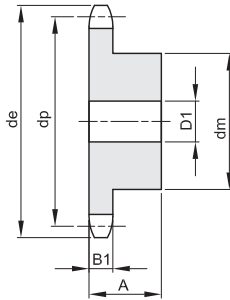
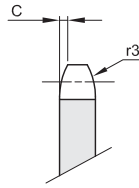

Materiale acciaio C45

Z	de	dp	semplici				doppi				tripli				
			dm	D1	A	Kg.	dm	D2	A	Kg.	dm	D3	A	Kg.	
8	48,4	41,48	25	10	25	0,11									
9	53,3	46,42	30	10	25	0,16									
10	58,3	51,37	35	10	25	0,22	35	12	40	0,37					
11	63,2	56,34	37	12	30	0,29									
12	68,2	61,34	42	12	30	0,37	44	16	40	0,54					
13	73,2	66,32	47	12	30	0,46	49	16	40	0,67					
14	78,2	71,34	52	12	30	0,56	54	16	40	0,82					
15	83,2	76,36	57	12	30	0,67	59	16	40	0,97					
16	88,3	81,37	60	12	30	0,75	64	16	45	1,25					
17	93,3	86,39	60	12	30	0,87	69	16	45	1,45					
18	98,3	91,42	70	14	30	1,00									
19	103,3	96,45	70	14	30	1,15	79	16	45	1,67					
20	108,4	101,49	75	14	30	1,20	84	16	45	2,14					
21	113,4	106,52	75	16	30	1,35	85	16	45	2,27					
22	118,4	111,55	80	16	30	1,40	90	16	45	2,54					
23	123,5	116,58	80	16	30	1,47	95	16	45	2,81					
24	128,5	121,62	80	16	30	1,53	100	16	45	3,11					
25	133,6	126,66	80	16	30	1,60	105	16	45	3,14					
26	138,6	131,70	85	20	35	1,96	110	20	45	3,74					
27	143,6	136,75	85	20	35	2,03	110	20	45	3,94					
28	148,7	141,78	90	20	35	2,25	115	20	45	4,28					
29	153,7	146,83	90	20	35	2,33									
30	158,8	151,87	90	20	35	2,41									
31	163,8	156,92	95	20	35	2,64									
32	168,9	161,95	95	20	35	2,73									
33	173,9	167,00	95	20	35	2,82									
34	178,9	172,05	95	20	35	2,91									
35	184,0	177,10	95	20	35	3,01									
36	189,0	182,15	100	20	35	3,26									
37	194,1	187,20	100	20	35	3,36									
38	199,1	192,24	100	20	35	3,47									
39	204,2	197,29	100	20	35	3,57									
40	209,2	202,34	100	20	35	3,68									

PIGNONI PER CATENE A RULLI - DIN 8188 - ISO 606 - ANSI B 29.1

SPROCKETS FOR ROLLER CHAINS - DIN 8188 - ISO 606 - ANSI B 29.1

ASA 60

19,05 x 12,7 mm
Rullo 11,91 mm
12A - 1 - 2

B1	B2	B3	b1	C	r3
11,6	34,1		11,3	2,4	20

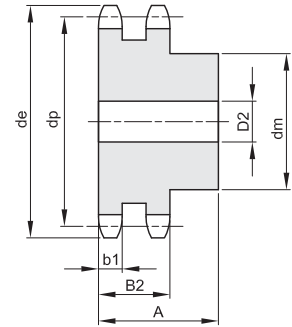
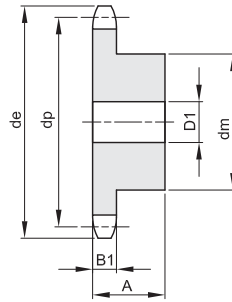
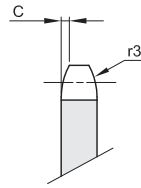

Materiale acciaio C45

Z	de	dp	semplici				doppi				tripli			
			dm	D1	A	Kg.	dm	D2	A	Kg.	dm	D3	A	Kg.
8	58,1	49,78												
9	64,0	55,70												
10	70,0	61,64	42	12	30	0,38	42	16	45	0,58				
11	76,0	67,61	46	16	35	0,50	47	16	50	0,80				
12	81,9	73,60	52	16	35	0,64	53	16	50	1,01				
13	87,9	79,59	58	16	35	0,80	59	16	50	1,24				
14	94,0	85,61	64	16	35	0,97	65	16	50	1,45				
15	100,0	91,63	70	16	35	1,16	71	16	50	1,73				
16	106,0	97,65	75	16	35	1,34	77	20	50	2,03				
17	112,0	103,67	80	16	35	1,53	83	20	50	2,35				
18	118,0	109,71	80	16	35	1,61	89	20	50	2,70				
19	124,1	115,75	80	16	35	1,70	95	20	50	3,06				
20	130,1	121,78	80	16	35	1,84	100	20	50	3,45				
21	136,2	127,82	90	20	40	2,35	100	20	50	3,69				
22	142,2	133,86	90	20	40	2,45	100	20	50	3,96				
23	148,2	139,90	90	20	40	2,56	110	20	50	4,50				
24	154,3	145,94	90	20	40	2,67	110	20	50	4,81				
25	160,3	152,00	90	20	40	2,79	120	20	50	5,40				
26	166,4	158,04	95	20	40	3,08	120	20	50	5,73				
27	172,4	164,09	95	20	40	3,21								
28	178,5	170,13	95	20	40	3,34	120	20	50	6,43				
29	184,5	176,19												
30	190,6	182,25	95	20	40	3,62	120	20	50	7,18				
31	196,6	188,31												
32	202,7	194,35	95	20	40	3,92								
33	208,8	200,40												
34	214,8	206,46	95	20	40	4,25								
35	220,9	212,52	95	20	40	4,41								
36	226,9	218,58	95	20	40	4,71								
37	233,0	224,64												
38	239,0	230,69	100	20	40	5,07								
39	245,1	236,75												
40	251,1	242,81	100	20	40	5,45								

PIGNONI PER CATENE A RULLI - DIN 8188 - ISO 606 - ANSI B 29.1
SPROCKETS FOR ROLLER CHAINS - DIN 8188 - ISO 606 - ANSI B 29.1

ASA 80

25,4 x 15,88 mm
Rullo 15,88 mm
16A - 1 - 2

B1	B2	B3	b1	C	r3
14,6	43,4		14,1	3,2	27

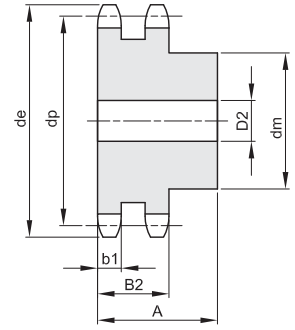
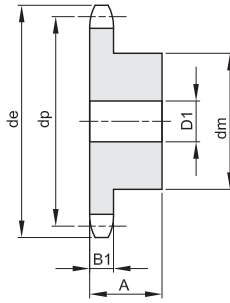
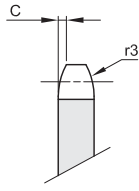

Materiale acciaio C45

Z	de	dp	semplici				doppi				tripli			
			dm	D1	A	Kg.	dm	D2	A	Kg.	dm	D3	A	Kg.
8	77,9	66,37	42	16	35	0,47								
9	85,8	74,27	50	16	35	0,65								
10	93,8	82,19	55	16	35	0,82								
11	101,7	90,14	61	16	40	1,13								
12	109,7	98,14	69	16	40	1,42								
13	117,7	106,12	78	16	40	1,77	80	20	70	3,22				
14	125,7	114,15	84	16	40	2,07	88	20	70	3,82				
15	133,7	122,17	92	16	40	2,46	96	20	70	4,51				
16	141,8	130,20	100	20	45	3,13	104	20	70	5,17				
17	149,8	138,22	100	20	45	3,34	112	20	70	5,97				
18	157,8	146,28	100	20	45	3,55	120	20	70	6,84				
19	165,9	154,33	100	20	45	3,78	128	20	70	7,75				
20	173,9	162,38	100	20	45	4,02	130	20	70	8,43				
21	182,0	170,43	110	20	50	5,01								
22	190,1	178,48	110	20	50	5,26								
23	198,1	186,53	110	20	50	5,56								
24	206,2	194,59	110	20	50	5,85								
25	214,2	202,66	110	20	50	6,16								
26	222,3	210,72	120	20	50	6,96								
27	230,4	218,79	120	20	50	7,29								
28	238,4	226,85	120	20	50	7,64								
29	246,5	234,92	120	20	50	7,78								
30	254,6	243,00	120	20	50	7,96								
31	262,6	251,08												
32	270,7	259,13												
33	278,8	267,21												
34	286,9	275,28	120	25	50	9,92								
35	294,9	283,36	120	25	50	10,36								
36	303,0	291,44												
37	311,1	299,51												
38	319,2	307,59	120	25	50	11,75								
39	327,2	315,67												
40	335,3	323,73												

PIGNONI PER CATENE A RULLI - DIN 8188 - ISO 606 - ANSI B 29.1

SPROCKETS FOR ROLLER CHAINS - DIN 8188 - ISO 606 - ANSI B 29.1

ASA 100

31,75 x 19,05 mm
Rullo 19,05 mm
20A - 1

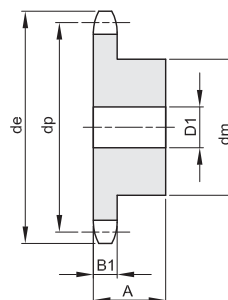
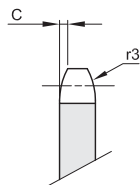

B1	B2	B3	b1	C	r3
17,6				4	33,5

Materiale acciaio C45

Z	de	dp	semplici				doppi				tripli			
			dm	D1	A	Kg.	dm	D2	A	Kg.	dm	D3	A	Kg.
8	96,0	82,96	53	20	40	0,85								
9	106,5	92,84	63	20	40	1,18								
10	117,0	102,74	70	20	40	1,57								
11	127,0	112,68	77	20	45	2,04								
12	137,0	122,68	88	20	45	2,58								
13	147,5	132,65	98	20	45	3,15								
14	157,6	142,68	108	20	45	3,78								
15	167,7	152,72	118	20	45	4,47								
16	177,7	162,75	120	25	50	5,25								
17	187,7	172,78	120	25	50	5,61								
18	197,8	182,85	120	25	50	5,99								
19	207,9	192,91	120	25	50	6,40								
20	217,9	202,98	120	25	50	6,82								
21	228,0	213,04	140	25	55	8,79								
22	238,1	223,11	140	25	55	9,27								
23	248,2	233,17	140	25	55	9,77								
24	258,3	243,23	140	25	55	10,30								
25	268,4	253,33	140	25	55	10,85								
26	278,4	263,40												
27	288,5	273,48												
28	298,5	283,56												
29	308,6	293,65												
30	318,7	303,75												
31	328,8	313,85												
32	338,9	323,91												
33	349,0	334,01												
34	359,1	344,10												
35	369,2	354,20												
36	379,2	364,30												
37	389,3	374,39												
38	399,4	384,49												
39	409,5	394,59												
40	419,6	404,66												

PIGNONI PER CATENE A RULLI - DIN 8188 - ISO 606 - ANSI B 29.1

SPROCKETS FOR ROLLER CHAINS - DIN 8188 - ISO 606 - ANSI B 29.1

ASA 120

38,1 x 25,4 mm
Rullo 22,23 mm
24A - 1

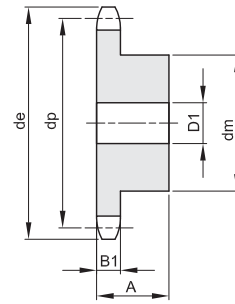
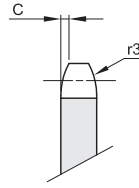

B1	B2	B3	b1	C	r3
23,5				4,8	40,5

Materiale acciaio C45 / * Materiale Fe - con mozzo saldato

Z	de	dp	semplici				doppi				tripli				
			dm	D1	A	Kg.	dm	D2	A	Kg.	dm	D3	A	Kg.	
8	113,0	99,55													
9	125,0	111,40													
10	137,0	123,29	80	20	45	2,67									
11	149,0	135,21	90	25	50	3,45									
12	161,0	147,22	102	25	50	4,26									
13	173,0	159,18	114	25	50	5,22									
14	185,0	171,22	128	25	50	6,29									
15	197,0	183,26	132	25	50	7,05									
16	209,0	195,30	136	25	55	8,41									
17	221,0	207,34	140	25	55	9,26									
18	233,0	219,42	140	25	55	9,95									
19	245,5	231,49													
20	257,5	243,57	140	25	55	11,56									
21	270,5	255,65													
22	282,5	267,73													
23	294,5	279,80													
24	307,0	291,88													
25	319,0	304,00	150	30	60	17,70									
26	331,0	316,08													
27	343,0	328,19													
28	355,0	340,27													
29	367,5	352,38													
30	379,5	364,50													
31	391,5	376,62													
32	403,5	388,69													
33	415,5	400,81													
34	428,0	412,93													
35	440,0	425,04	*150	30	60	30,01									
36	452,0	437,16													
37	464,0	449,27													
38	476,5	461,39													
39	488,5	473,50													
40	501,5	485,62													

PIGNONI PER CATENE A RULLI - DIN 8188 - ISO 606 - ANSI B 29.1

SPROCKETS FOR ROLLER CHAINS - DIN 8188 - ISO 606 - ANSI B 29.1

ASA 140

44,45 x 25,4 mm
Rullo 25,4 mm
28A - 1

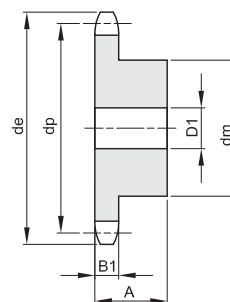
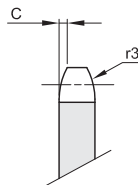

B1	B2	B3	b1	C	r3
23,5				5,8	47,5

Materiale acciaio C45

Z	de	dp	semplici				doppi				tripli			
			dm	D1	A	Kg.	dm	D2	A	Kg.	dm	D3	A	Kg.
8	132,0	116,15												
9	146,0	129,96												
10	160,0	143,85	100	25	70	5,23								
11	174,0	157,77	112	25	70	6,53								
12	188,0	171,74	125	25	70	8,02								
13	204,0	185,75	125	25	70	8,72								
14	218,0	199,76	125	25	70	9,46								
15	232,0	213,79												
16	246,0	227,84	160	30	75	14,65								
17	260,0	241,90	160	30	75	15,50								
18	274,0	255,98												
19	289,0	270,06												
20	303,0	284,15												
21	317,0	298,24												
22	331,0	312,34												
23	345,0	326,44												
24	359,0	340,55												
25	373,0	354,66												
26	387,0	368,77												
27	401,0	382,88												
28	416,0	397,00												
29	430,0	411,12												
30	444,0	425,24												
31	458,0	439,37												
32	472,0	453,49												
33	486,0	467,62												
34	500,0	481,75												
35	514,0	495,88												
36	529,0	510,01												
37	543,0	524,13												
38	557,0	538,27												
39	571,0	552,40												
40	585,0	566,54												

CORONE PER CATENE A RULLI - DIN 8187 - ISO 606

PLATE WHEELS FOR ROLLER CHAINS - DIN 8187 - ISO 606

5 x 2,5 mm

Rullo 3,2 mm

03 - 1

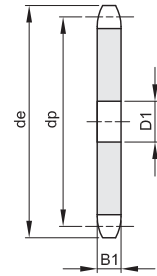
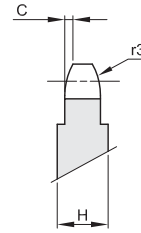
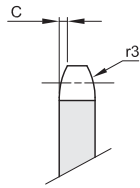

Da Z 51 H=4 mm

B1	B2	B3	b1	C	r3
2,3				0,4	5

Z	de	dp	semplici D1	Kg.	doppie D2	Kg.	triple D3	Kg.
8	14,8	13,06	4	0,01				
9	16,4	14,62	4	0,01				
10	17,9	16,18	4	0,01				
11	19,5	17,75	5	0,01				
12	21,1	19,32	5	0,01				
13	22,6	20,89	5	0,01				
14	24,2	22,47	5	0,01				
15	25,8	24,04	5	0,01				
16	27,4	25,63	6	0,01				
17	29,0	27,20	6	0,01				
18	30,5	28,79	6	0,01				
19	32,1	30,38	6	0,01				
20	33,7	31,96	6	0,01				
21	35,3	33,54	8	0,01				
22	36,9	35,13	8	0,02				
23	38,5	36,72	8	0,02				
24	40,1	38,30	8	0,02				
25	41,6	39,89	8	0,02				
26	43,2	41,48	8	0,02				
27	44,8	43,07	8	0,02				
28	46,4	44,65	8	0,03				
29	48,0	46,25						
30	49,6	47,83	8	0,03				
31	51,2	49,42						
32	52,8	51,01	8	0,03				
33	54,4	52,60	8	0,04				
34	55,9	54,19	8	0,04				
35	57,5	55,78	8	0,04				
36	59,1	57,37	8	0,04				
37	60,7	58,96	8	0,05				
38	62,3	60,54	8	0,05				
39	63,9	62,13						
40	65,5	63,73	8	0,05				
41	67,1	65,31						
42	68,7	66,91	8	0,06				
43	70,2	68,49						
44	71,8	70,09	8	0,07				
45	73,4	71,68	8	0,07				
46	75,0	73,27	8	0,07				
47	76,6	74,86						
48	78,2	76,45	8	0,08				
49	79,8	78,03						
50	81,4	79,63	8	0,08				

Z	de	dp	semplici D1	Kg.	doppie D2	Kg.	triple D3	Kg.
51	83,0	81,22						
52	84,6	82,81	10	0,17				
53	86,2	84,40						
54	87,7	85,97	10	0,18				
55	89,3	87,58	10	0,19				
56	90,9	89,17	10	0,20				
57	92,6	90,76	10	0,20				
58	94,1	92,35	10	0,21				
59	95,7	93,94						
60	97,3	95,53	10	0,23				
62	100,5	98,72	12	0,24				
64	103,7	101,90						
65	105,2	103,49	12	0,27				
66	106,8	105,08	12	0,28				
68	110,0	108,26						
70	113,2	111,44	12	0,31				
72	116,4	114,63						
75	121,2	119,40	12	0,36				
76	122,7	120,99	12	0,37				
78	125,9	124,17						
80	129,1	127,35	12	0,41				
85	137,1	135,31	14	0,46				
90	145,0	143,27	14	0,52				
95	153,0	151,22	14	0,58				
100	160,9	159,18	14	0,65				
110	176,8	175,09	14	0,79				
114	183,2	181,46	14	0,85				
120	192,8	191,01	14	0,95				
125	200,7	198,96	14	1,03				

CORONE PER CATENE A RULLI - DIN 8187 - ISO 606

PLATE WHEELS FOR ROLLER CHAINS - DIN 8187 - ISO 606

6 x 2,8 mm

Rullo 4 mm

04 - 1

B1	B2	B3	b1	C	r3
2,6				0,6	6

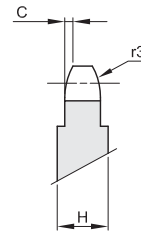
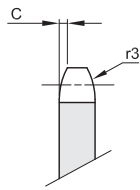

Da Z 51 H=4 mm

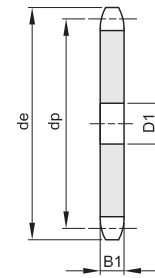

Z	de	dp	semplici D1	Kg.	doppie D2	Kg.	triple D3	Kg.
8	18,0	15,67	5	0,01				
9	19,9	17,54	5	0,01				
10	21,7	19,42	6	0,01				
11	23,6	21,30	6	0,01				
12	25,4	23,18	6	0,01				
13	27,3	25,05	8	0,01				
14	29,2	26,96	8	0,01				
15	31,1	28,86	8	0,01				
16	33,0	30,76	8	0,01				
17	35,0	32,65	8	0,01				
18	36,9	34,55	8	0,02				
19	38,8	36,44	8	0,02				
20	40,7	38,44	8	0,02				
21	42,6	40,25	8	0,02				
22	44,5	42,16	8	0,02				
23	46,4	44,06	8	0,03				
24	48,3	45,96	8	0,03				
25	50,2	47,87	8	0,03				
26	52,1	49,77	8	0,03				
27	54,0	51,67	8	0,04				
28	55,9	53,58	8	0,04				
29	57,8	55,50						
30	59,8	57,42	8	0,05				
31	61,7	59,31						
32	63,6	61,21	10	0,05				
33	65,5	63,11	10	0,06				
34	67,4	65,02	10	0,06				
35	69,3	66,93	10	0,07				
36	71,2	68,84	10	0,07				
37	73,1	70,75	10	0,07				
38	75,0	72,66	10	0,08				
39	76,9	74,56						
40	78,9	76,47	10	0,09				
41	80,8	78,38						
42	82,7	80,28	12	0,10				
43	84,7	82,19						
44	86,6	84,10						
45	88,5	86,01	12	0,11				
46	90,4	87,92	12	0,12				
47	92,3	89,83						
48	94,2	91,74	12	0,13				
49	96,1	93,64						
50	98,0	95,55	12	0,14				

Z	de	dp	semplici D1	Kg.	doppie D2	Kg.	triple D3	Kg.
51	99,9	97,47						
52	101,8	99,37	12	0,25				
53	103,7	101,27						
54	105,6	103,17	12	0,26				
55	107,6	105,08	12	0,27				
56	109,5	107,00	12	0,28				
57	111,4	108,93	12	0,29				
58	113,3	110,82	12	0,30				
59	115,2	112,71						
60	117,5	114,62	12	0,33				
62	120,9	118,45	16	0,35				
64	124,7	122,27	16	0,37				
65	126,6	124,18	16	0,38				
66	128,5	126,09	16	0,40				
68	132,4	129,91						
70	136,2	133,73	16	0,45				
72	140,0	137,55						
75	145,7	143,28						
76	148,1	145,19	16	0,53				
78	151,5	149,01						
80	155,3	152,82	16	0,59				
85	164,8	162,37	16	0,67				
90	174,4	171,92	16	0,77				
95	183,9	181,47	16	0,85				
100	193,5	191,01	16	0,94				
110	211,6	210,11						
114	220,2	217,75	16	1,23				
120	231,7	229,20	16	1,37				
125	241,2	238,75	16	1,48				

CORONE PER CATENE A RULLI - DIN 8187 - ISO 606

PLATE WHEELS FOR ROLLER CHAINS - DIN 8187 - ISO 606

8 x 3,0 mm

Rullo 5 mm

05B - 1 - 2

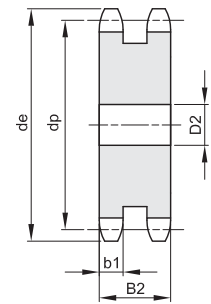
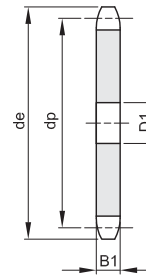
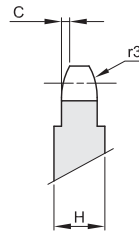
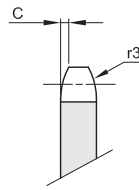

Da Z 46 H=4 mm

B1	B2	B3	b1	C	r3
2,8	8,3		2,7	0,8	8

Z	de	dp	semplici D1 Kg.	doppie D2 Kg.	triple D3 Kg.
8	23,4	20,90	6 0,01	8 0,01	
9	25,9	23,39	6 0,01	8 0,01	
10	28,4	25,89	8 0,01	8 0,02	
11	31,0	28,39	8 0,01	8 0,02	
12	33,7	30,91	8 0,01	8 0,03	
13	36,7	33,42	8 0,01	8 0,04	
14	39,2	35,95	8 0,02	8 0,05	
15	41,7	38,48	8 0,02	8 0,06	
16	44,2	41,01	8 0,02	10 0,07	
17	46,7	43,53	8 0,03	10 0,08	
18	49,2	46,07	8 0,03	10 0,09	
19	51,7	48,61	8 0,03	10 0,10	
20	54,2	51,14	8 0,04		
21	57,2	53,67	10 0,04	10 0,13	
22	59,4	56,21	10 0,05	10 0,14	
23	62,2	58,75	10 0,05	10 0,16	
24	64,7	61,29	10 0,06	10 0,17	
25	67,2	63,83	10 0,06	10 0,18	
26	69,7	66,37	10 0,07	12 0,18	
27	72,3	68,91	10 0,07		
28	74,7	71,45	10 0,08	12 0,22	
29	77,2	73,99	10 0,09		
30	80,2	76,53	10 0,09	12 0,25	
31	82,7	79,08	10 0,10		
32	85,2	81,61	10 0,11	12 0,29	
33	87,7	84,16	10 0,11		
34	90,2	86,70	10 0,12	12 0,34	
35	92,7	89,24	10 0,13	12 0,36	
36	95,2	91,79	10 0,13	12 0,38	
37	97,7	94,33	12 0,14		
38	100,2	96,88	12 0,15	12 0,42	
39	102,7	99,42	12 0,16		
40	105,2	101,97	12 0,17	12 0,47	
41	108,4	104,51			
42	111,0	107,05	12 0,28		
43	113,5	109,60			
44	116,1	112,14	12 0,31		
45	118,6	114,69	12 0,32		
46	121,2	117,23	12 0,34	16 0,63	
47	123,7	119,77			
48	125,5	122,32	12 0,37	16 0,69	
49	128,9	124,86			
50	131,5	127,41	12 0,40	16 0,75	

Z	de	dp	semplici D1 Kg.	doppie D2 Kg.	triple D3 Kg.
51	134,0	129,95			
52	136,6	132,49	16 0,43	16 0,82	
53	139,1	135,04			
54	141,7	137,59	16 0,47		
55	144,2	140,13	16 0,49		
56	146,8	142,68		16 0,96	
57	149,3	145,22	16 0,53	16 0,99	
58	151,9	147,77	16 0,55		
59	154,5	150,31			
60	156,0	152,85	16 0,59	16 1,11	
62	162,2	157,95	16 0,63		
64	167,3	163,04	16 0,67		
65	169,8	165,58	16 0,69	20 1,30	
66	172,4	168,13			
68	177,5	173,22			
70	182,6	178,31	16 0,81		
72	187,7	183,41			
75	195,3	191,04	20 0,93		
76	196,7	193,59	20 0,94	20 1,80	
78	203,0	198,68			
80	208,1	203,77	20 1,01	20 2,00	
85	220,8	216,50	20 1,20		
90	233,6	229,23	20 1,35		
95	246,3	241,96	20 1,51		
100	259,1	254,68	20 1,68		
110	284,6	280,15			
114	294,8	290,33	20 2,20	20 4,15	
120	310,1	305,61	20 2,44		
125	322,8	318,34	20 2,65		

CORONE PER CATENE A RULLI - DIN 8187 - ISO 606

PLATE WHEELS FOR ROLLER CHAINS - DIN 8187 - ISO 606

3/8" x 7/32"
9,525 x 5,72 mm
Rullo 6,35 mm
06B - 1 - 2 - 3

B1	B2	B3	b1	C	r3
5,3	15,4	25,6	5,2	1	10

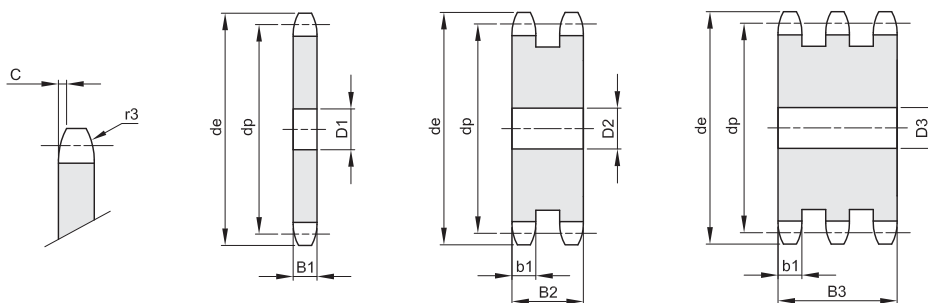

Z	de	dp	semplici D1 Kg.	doppie D2 Kg.	triple D3 Kg.
8	28,6	24,89	6 0,01	8 0,03	8 0,04
9	31,5	27,85	8 0,02	8 0,04	8 0,06
10	34,5	30,82	8 0,02	8 0,05	10 0,08
11	37,5	33,80	8 0,03	10 0,06	12 0,09
12	40,5	36,80	8 0,03	10 0,08	12 0,12
13	43,5	39,80	8 0,04	10 0,10	12 0,15
14	46,5	42,80	8 0,05	10 0,12	12 0,18
15	49,5	45,81	8 0,06	10 0,14	12 0,22
16	52,5	48,82	10 0,06	12 0,16	12 0,26
17	55,5	51,83	10 0,07	12 0,19	12 0,30
18	58,6	54,85	10 0,08	12 0,21	12 0,35
19	61,6	57,87	10 0,09	12 0,24	12 0,39
20	64,6	60,89	10 0,10	12 0,27	12 0,44
21	67,6	63,91	10 0,12	12 0,30	16 0,48
22	70,6	66,93	10 0,13	12 0,34	16 0,54
23	73,7	69,95	10 0,14	12 0,37	16 0,59
24	76,7	72,97	10 0,15	12 0,41	16 0,66
25	79,7	76,00	10 0,17	12 0,45	16 0,72
26	82,7	79,02	10 0,18	16 0,48	16 0,79
27	85,7	82,04	10 0,20	16 0,53	16 0,86
28	88,8	85,07	10 0,21	16 0,57	16 0,93
29	91,8	88,09	10 0,23	16 0,62	16 1,01
30	94,8	91,12	10 0,25	16 0,66	16 1,09
31	97,9	94,15	12 0,26	16 0,71	16 1,17
32	100,9	97,17	12 0,28	16 0,77	16 1,26
33	103,9	100,20	12 0,30	16 0,82	
34	106,9	103,23	12 0,32	16 0,87	16 1,44
35	110,0	106,26	12 0,34	16 0,93	16 1,53
36	113,0	109,29	12 0,36	16 0,99	20 1,61
37	116,0	112,32	12 0,38	16 1,05	
38	119,0	115,34	12 0,40	16 1,11	20 1,81
39	122,1	118,37	12 0,43	16 1,18	
40	125,1	121,40	12 0,45	16 1,24	20 2,02
41	129,0	124,43	16 0,47	20 1,30	
42	132,1	127,46	16 0,49	20 1,36	20 2,25
43	135,1	130,49	16 0,52	20 1,44	
44	138,1	133,52	16 0,55	20 1,51	20 2,49
45	141,1	136,54	16 0,57	20 1,58	20 2,61
46	144,2	139,58	16 0,60	20 1,66	
47	147,2	142,61	16 0,63		
48	150,2	145,64	16 0,65	20 1,82	20 2,99
49	153,3	148,66	16 0,68	20 1,90	
50	156,3	151,69	20 0,71	20 1,98	20 3,27

Z	de	dp	semplici D1 Kg.	doppie D2 Kg.	triple D3 Kg.
51	159,3	154,72	20 0,74	20 2,06	
52	162,4	157,75	20 0,77	20 2,15	
53	165,4	160,78	20 0,80	20 2,22	
54	168,4	163,82	20 0,83	20 2,33	
55	171,4	166,85	20 0,86	20 2,42	
56	174,5	169,88	20 0,89	20 2,51	
57	177,5	172,91	20 0,93	20 2,61	25 4,28
58	180,5	175,93	20 0,96	20 2,71	25 4,44
60	186,6	181,99	20 1,03	20 2,91	25 4,77
62	192,7	188,06	20 1,10	25 3,09	
64	198,7	194,12	20 1,18	25 3,30	25 5,46
65	201,8	197,15	20 1,21	25 3,41	25 5,64
66	204,8	200,18	20 1,25		25 5,83
68	210,8	206,24	20 1,33	25 3,75	
70	216,9	212,30	20 1,41	25 3,99	25 6,59
72	223,0	218,37	20 1,50	25 4,23	25 6,99
75	232,1	227,46	20 1,63	25 4,60	
76	235,1	230,49	20 1,67	25 4,73	25 7,83
78	241,2	236,55		25 4,99	
80	247,2	242,61	20 1,86	25 5,26	25 8,71
85	262,4	257,77	25 2,10	25 5,96	25 9,87
90	277,5	272,93	25 2,36	25 6,71	25 11,11
95	292,7	288,08	25 2,63	25 7,50	25 12,42
100	307,8	303,25	25 2,92	25 8,34	25 13,81
110	338,2	333,55	25 3,54	25 10,14	
114	350,3	345,68	25 3,81	25 10,90	25 18,06
120	368,5	363,86	25 4,23	25 12,11	
125	383,6	379,02	25 4,59	25 13,16	25 21,81

CORONE PER CATENE A RULLI - DIN 8187 - ISO 606

PLATE WHEELS FOR ROLLER CHAINS - DIN 8187 - ISO 606

1/2" x 1/8"
12,7 x 3,3 mm
 Rullo 7,75 mm
081 - 1

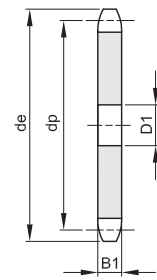
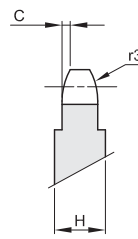
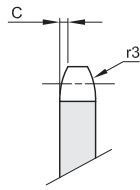

Da Z 31 H=4 mm
 Da Z 90 H=6 mm

B1	B2	B3	b1	C	r3
3				0,8	13

Z	de	dp	semplici D1	doppie D2	triple D3	Kg.
8	39,5	33,18				
9	43,4	37,13	8			0,02
10	47,4	41,10	8			0,02
11	51,4	45,07	8			0,03
12	55,4	49,07	8			0,04
13	59,4	53,06	8			0,04
14	63,4	57,07	8			0,05
15	67,4	61,09	8			0,06
16	71,4	65,10	8			0,07
17	75,4	69,11	8			0,08
18	79,4	73,14	8			0,09
19	83,5	77,16	8			0,10
20	87,5	81,19	8			0,11
21	91,5	85,22	8			0,11
22	95,5	89,24	10			0,13
23	99,6	93,27	10			0,15
24	103,6	97,29	12			0,16
25	107,6	101,33	12			0,17
26	111,7	105,36	12			0,26
27	115,7	109,40	12			0,28
28	119,7	113,42	12			0,32
29	123,8	117,46				
30	127,8	121,50	12			0,35
31	131,8	125,54				
32	135,9	129,56	12			0,40
33	139,9	133,60	12			0,43
34	143,9	137,64	12			0,46
35	148,0	141,68	12			0,49
36	152,0	145,72	16			0,51
37	156,1	149,76	16			0,55
38	160,1	153,80	16			0,58
39	164,1	157,83	16			0,61
40	168,2	161,87	16			0,64
41	172,7	165,91				
42	176,7	169,95				
43	180,8	173,99				
44	184,8	178,03	16			0,79
45	188,9	182,07	16			0,82
46	192,9	186,10				
47	196,9	190,14				
48	201,0	194,18	20			0,94
49	205,0	198,22				
50	209,1	202,26				

Z	de	dp	semplici D1	doppie D2	triple D3	Kg.
51	213,1	206,30				
52	217,1	210,34				
53	221,2	214,87				
54	225,2	218,43				
55	229,3	222,46	20			1,25
56	233,3	226,50	20			1,30
57	237,3	230,54	20			1,35
58	241,4	234,58				
59	245,4	238,62				
60	249,5	242,66	20			1,50
62	257,5	250,75				
64	265,6	258,82				
65	269,7	262,86				
66	273,7	266,90				
68	281,8	274,99				
70	289,9	283,07	25			2,05
72	298,0	291,16				
75	310,1	303,27				
76	314,1	307,33				
78	322,2	315,40				
80	330,3	323,48				
85	350,5	343,69				
90	370,7	363,90				
95	390,9	384,11				
100	411,1	404,31				
110	451,5	444,74				
114	467,7	460,90				
120	492,0	485,16				
125	512,2	505,37				

CORONE PER CATENE A RULLI - DIN 8187 - ISO 606

PLATE WHEELS FOR ROLLER CHAINS - DIN 8187 - ISO 606

1/2" x 3/16"
12,7 x 4,88 mm
Rullo 7,75 mm
083 - 1 / 084 - 1

B1	B2	B3	b1	C	r3
4,5				1,3	13

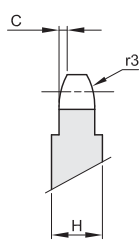
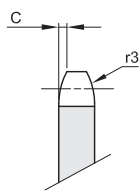

Da Z 90 H=6 mm

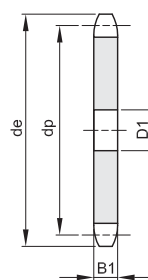

Z	de	dp	semplici D1	doppie D2	triple D3
			Kg.	Kg.	Kg.
8	39,5	33,18	8	0,02	
9	43,4	37,13	8	0,03	
10	47,4	41,10	8	0,04	
11	51,4	45,07	8	0,05	
12	55,4	49,07	8	0,05	
13	59,4	53,06	8	0,06	
14	63,4	57,07	8	0,08	
15	67,4	61,09	8	0,09	
16	71,4	65,10	8	0,10	
17	75,4	69,11	8	0,12	
18	79,4	73,14	8	0,13	
19	83,5	77,16	8	0,15	
20	87,5	81,19	8	0,16	
21	91,5	85,22	8	0,18	
22	95,5	89,24	10	0,20	
23	99,6	93,27	10	0,22	
24	103,6	97,29	12	0,24	
25	107,6	101,33	12	0,26	
26	111,7	105,36	12	0,28	
27	115,7	109,40	12	0,30	
28	119,7	113,42	12	0,33	
29	123,8	117,46	12	0,35	
30	127,8	121,50	12	0,38	
31	131,8	125,54	12	0,40	
32	135,9	129,56	12	0,43	
33	139,9	133,60	12	0,46	
34	143,9	137,64	12	0,49	
35	148,0	141,68	12	0,52	
36	152,0	145,72	16	0,55	
37	156,1	149,76	16	0,58	
38	160,1	153,80	16	0,62	
39	164,1	157,83	16	0,65	
40	168,2	161,87	16	0,68	
41	172,7	165,91	16	0,72	
42	176,7	169,95	16	0,76	
43	180,8	173,99	16	0,80	
44	184,8	178,03	16	0,83	
45	188,9	182,07	16	0,87	
46	192,9	186,10	20	0,91	
47	196,9	190,14	20	0,95	
48	201,0	194,18	20	0,99	
49	205,0	198,22	20	1,04	
50	209,1	202,26	20	1,08	

Z	de	dp	semplici D1	doppie D2	triple D3
			Kg.	Kg.	Kg.
51	213,1	206,30	20	1,12	
52	217,1	210,34	20	1,17	
53	221,2	214,37	20	1,22	
54	225,2	218,43	20	1,26	
55	229,3	222,46	20	1,31	
56	233,3	226,50	20	1,36	
57	237,3	230,54	20	1,41	
58	241,4	234,58	20	1,46	
59	245,5	238,62			
60	249,5	242,66	20	1,57	
62	257,5	250,75			
64	265,6	258,82	20	1,80	
65	269,7	262,86	20	1,85	
66	273,7	266,90			
68	281,8	274,99	25	2,02	
70	289,9	283,07	25	2,14	
72	298,0	291,16	25	2,27	
75	310,1	303,27			
76	314,1	307,33	25	2,54	
78	322,2	315,40			
80	330,3	323,48	25	2,82	
85	350,5	343,69	25	3,19	
90	370,7	363,90			
95	390,9	384,11			
100	411,1	404,31	25	5,83	
110	451,5	444,74			
114	467,7	460,90			
120	492,0	485,16			
125	512,2	505,37			

CORONE PER CATENE A RULLI - DIN 8187 - ISO 606

PLATE WHEELS FOR ROLLER CHAINS - DIN 8187 - ISO 606

1/2" x 5/16"
12,7 x 7,5 mm
Rullo 8,51 mm
08B - 1 - 2 - 3

B1	B2	B3	b1	C	r3
7,2	21	34,9	7	1,3	13

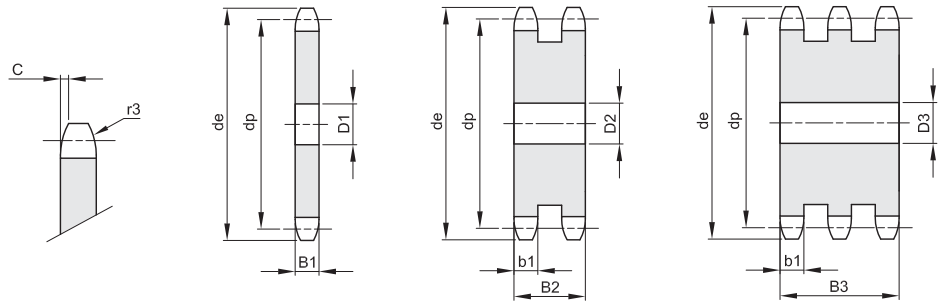

Z	de	dp	semplici D1 Kg.	doppie D2 Kg.	triple D3 Kg.
8	38,0	33,18	8 0,03	10 0,07	10 0,11
9	42,0	37,13	8 0,04	10 0,10	10 0,16
10	45,9	41,10	8 0,06	10 0,13	10 0,21
11	49,9	45,07	10 0,07	10 0,17	12 0,26
12	53,9	49,07	10 0,08	10 0,21	12 0,33
13	57,9	53,06	10 0,10	10 0,25	12 0,40
14	61,9	57,07	10 0,12	10 0,30	12 0,48
15	65,9	61,09	10 0,14	10 0,36	12 0,57
16	69,9	65,10	10 0,16	12 0,41	16 0,64
17	74,0	69,11	10 0,18	12 0,47	16 0,74
18	78,0	73,14	10 0,20	12 0,54	16 0,85
19	82,0	77,16	10 0,23	12 0,61	16 0,97
20	86,0	81,19	10 0,26	12 0,68	16 1,09
21	90,1	85,22	12 0,28	16 0,75	16 1,22
22	94,1	89,24	12 0,31	16 0,83	16 1,36
23	98,1	93,27	12 0,34	16 0,92	16 1,50
24	102,1	97,29	12 0,38	16 1,01	16 1,63
25	106,2	101,33	12 0,41	16 1,10	16 1,81
26	110,2	105,36	16 0,44	16 1,20	16 1,98
27	114,2	109,40	16 0,48	16 1,31	16 2,15
28	118,3	113,42	16 0,52	16 1,42	16 2,33
29	122,3	117,46	16 0,56	16 1,53	16 2,52
30	126,3	121,50	16 0,60	16 1,65	16 2,71
31	130,4	125,54	16 0,64	16 1,77	
32	134,4	129,56	16 0,68	16 1,90	20 3,09
33	138,4	133,60	16 0,73	16 2,02	20 3,30
34	142,5	137,64	16 0,78	16 2,16	20 3,53
35	146,5	141,68	16 0,83	16 2,30	20 3,76
36	150,6	145,72	16 0,88	20 2,42	20 3,99
37	154,6	149,76	16 0,93	20 2,56	
38	158,6	153,80	16 0,98	20 2,71	20 4,49
39	162,7	157,83	16 1,03	20 2,87	
40	166,7	161,87	16 1,09	20 3,03	20 5,00
41	172,4	165,91	20 1,14	20 3,20	
42	176,5	169,95	20 1,20	20 3,36	25 5,51
43	180,5	173,99	20 1,26	20 3,53	25 5,80
44	184,6	178,03	20 1,32	20 3,71	25 6,09
45	188,6	182,07	20 1,38	20 3,89	25 6,39
46	192,6	186,10	20 1,45	20 4,07	25 6,70
47	196,7	190,14	20 1,51		25 7,00
48	200,7	194,18	20 1,58	20 4,96	r3 7,33
49	204,8	198,22	20 1,65	20 4,66	
50	208,8	202,26	20 1,72	20 4,86	25 8,00

Z	de	dp	semplici D1 Kg.	doppie D2 Kg.	triple D3 Kg.
51	212,8	206,30	20 1,80	25 5,03	
52	216,9	210,34	20 1,87	25 5,24	25 8,68
53	220,9	214,37	20 1,94	25 5,46	
54	225,0	218,43	20 2,02	25 5,68	25 9,40
55	229,0	222,46	20 2,10	25 5,90	25 9,77
56	233,0	226,50	20 2,17	25 6,13	25 10,15
57	237,1	230,54	20 2,25	25 6,36	25 10,53
58	241,1	234,58	20 2,34	25 6,59	
59	245,2	238,62			
60	249,2	242,66	20 2,50	25 7,08	25 11,73
62	257,3	250,75	25 2,67	25 7,60	25 15,56
64	265,4	258,82	25 2,85	25 8,10	
65	269,4	262,86	25 2,94	25 8,36	25 13,86
66	273,4	266,90	25 3,03		
68	281,5	274,99	25 3,22	25 9,20	25 15,22
70	289,6	283,07	25 3,42	25 9,75	25 16,17
72	297,7	291,16	25 3,62	25 10,33	25 17,14
75	309,8	303,27	25 3,94	25 11,24	25 18,65
76	313,9	307,33	25 4,05	25 11,55	25 19,17
78	321,9	315,40	25 4,27		
80	330,0	323,48	25 4,50	25 12,90	25 21,82
85	350,2	343,69	25 5,62	25 14,55	25 24,15
90	370,4	363,90	25 6,31	25 16,36	25 27,17
95	390,7	384,11	25 7,05	25 18,28	25 30,36
100	410,9	404,31	25 7,82	25 20,30	25 33,73
110	451,3	444,74	25 9,50	25 24,67	
114	467,4	460,90	25 10,21	25 26,53	25 44,10
120	491,7	485,16	25 11,32	25 29,46	
125	511,0	505,37	25 12,31	25 32,00	25 55,21

CORONE PER CATENE A RULLI - DIN 8187 - ISO 606

PLATE WHEELS FOR ROLLER CHAINS - DIN 8187 - ISO 606

5/8" x 3/8"

15,875 x 9,65 mm
Rullo 10,16 mm
10B - 1 - 2 - 3

B1	B2	B3	b1	C	r3
9,1	25,5	42,1	9	1,6	16

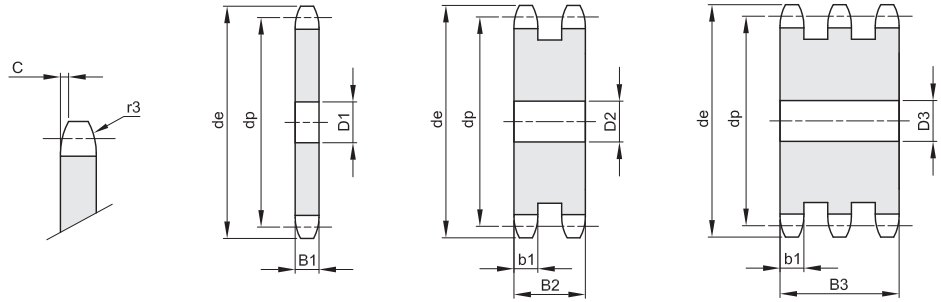

Z	de	dp	semplici D1 Kg.	doppie D2 Kg.	triple D3 Kg.
8	48,4	41,48	10 0,06	10 0,15	12 0,23
9	53,3	46,42	10 0,09	10 0,21	12 0,32
10	58,3	51,37	10 0,11	10 0,27	12 0,44
11	63,2	56,34	10 0,14	10 0,34	12 0,55
12	68,2	61,34	10 0,17	10 0,42	12 0,67
13	73,2	66,32	10 0,20	10 0,51	12 0,81
14	78,2	71,34	12 0,23	10 0,60	12 0,97
15	83,2	76,36	12 0,27	12 0,70	12 1,14
16	88,3	81,37	12 0,31	12 0,82	16 1,29
17	93,3	86,39	12 0,36	12 0,94	16 1,49
18	98,3	91,42	12 0,41	12 1,06	16 1,70
19	103,3	96,45	12 0,46	12 1,20	16 1,92
20	108,4	101,49	12 0,51	12 1,34	16 2,15
21	113,4	106,52	12 0,57	16 1,48	16 2,40
22	118,4	111,55	12 0,62	16 1,64	16 2,66
23	123,5	116,58	12 0,69	16 1,80	16 2,94
24	128,5	121,62	12 0,75	16 1,98	16 3,23
25	133,6	126,66	12 0,82	16 2,17	16 3,53
26	138,6	131,70	16 0,88	20 2,33	20 3,81
27	143,6	136,75	16 0,95	20 2,53	20 4,13
28	148,7	141,78	16 1,03	20 2,74	20 4,47
29	153,7	146,83	16 1,11	20 2,96	20 4,83
30	158,8	151,87	16 1,19	20 3,18	20 5,20
31	163,8	156,92	16 1,28	20 3,41	
32	168,9	161,95	16 1,36	20 3,66	20 5,97
33	173,9	167,00	16 1,45	20 3,90	20 6,38
34	178,9	172,05	16 1,55	20 4,16	20 6,80
35	184,0	177,10	16 1,64	20 4,42	20 7,23
36	189,0	182,15	20 1,73	20 4,70	25 7,62
37	194,1	187,20	20 1,83	20 4,98	25 8,08
38	199,1	192,24	20 1,94	20 5,26	25 8,55
39	204,2	197,29	20 2,05	20 5,56	25 9,04
40	209,2	202,34	20 2,16	20 5,87	25 9,54
41	215,8	207,39	20 2,29		25 10,05
42	220,8	212,44	20 2,39	25 6,46	25 10,58
43	225,9	217,49	20 2,50	25 6,80	
44	230,9	222,53	20 2,63	25 7,13	25 11,67
45	236,0	227,58	20 2,75	25 7,47	25 12,24
46	241,0	236,63	20 2,88	25 7,83	25 12,82
47	246,1	237,68	20 3,01	25 8,19	
48	251,1	242,73	20 3,14	25 8,55	25 14,01
49	256,2	247,78	20 3,28		
50	261,2	252,82	20 3,42	25 9,32	25 15,26

Z	de	dp	semplici D1 Kg.	doppie D2 Kg.	triple D3 Kg.
51	266,3	257,87	20 3,56		
52	271,3	262,92	20 3,70	25 10,11	25 16,57
53	276,4	267,97	20 3,85	25 10,52	
54	281,4	273,03	20 4,00	25 10,94	
55	286,5	278,08	20 4,15	25 11,36	25 18,62
56	291,5	283,13	25 4,30	25 11,80	
57	296,6	288,18	25 4,46	25 12,24	25 20,06
58	301,6	293,23	25 4,62	25 12,68	
60	311,7	303,32	25 4,95	25 13,61	25 22,31
62	321,8	313,43	25 5,30	25 14,56	
64	331,9	323,53	25 5,65		30 25,43
65	337,0	328,58	25 5,83	25 16,05	30 26,26
66	342,0	333,63		25 16,57	
68	352,1	343,74	25 6,40		
70	362,2	353,84	25 6,79	25 18,70	30 30,61
72	372,3	363,95	25 7,19	25 19,81	
75	387,5	379,09	25 7,81	25 21,54	30 30,35
76	392,5	384,16	25 8,02	25 22,14	30 36,27
78	402,6	394,25	25 8,46		
80	412,7	404,35	25 8,91	25 24,60	30 40,30
85	438,0	429,62	30 10,06	30 28,00	
90	463,3	454,88	30 11,30	30 31,25	30 51,32
95	488,5	480,14	30 12,61	30 34,90	30 57,32
100	513,8	505,40	30 13,99	30 38,75	
110	564,3	555,92	30 17,00		
114	584,5	576,13	30 19,99	30 50,60	30 83,15
120	614,8	606,44	30 22,17	30 56,16	
125	640,1	631,71	30 24,08	30 61,00	30 100,29

CORONE PER CATENE A RULLI - DIN 8187 - ISO 606

PLATE WHEELS FOR ROLLER CHAINS - DIN 8187 - ISO 606

3/4" x 7/16"

19,05 x 11,68 mm

Rullo 12,07 mm

12B - 1 - 2 - 3

B1	B2	B3	b1	C	r3
11,1	30,3	49,8	10,8	2	19

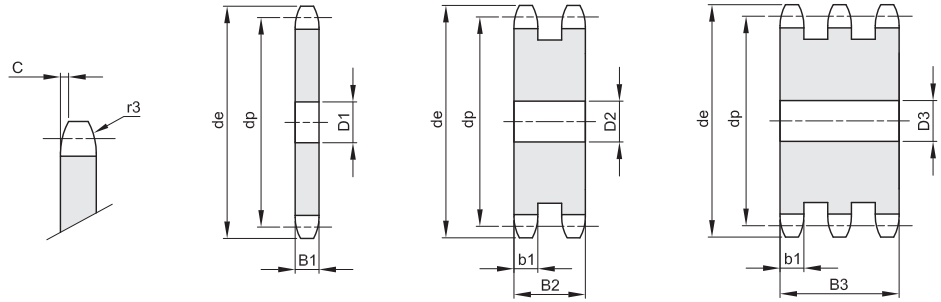

Z	de	dp	semplici D1 Kg.		doppie D2 Kg.		triple D3 Kg.	
8	58,0	49,78	10	0,12	12	0,26	12	0,31
9	63,9	55,70	10	0,15	12	0,36	12	0,57
10	69,8	61,64	10	0,20	12	0,46	12	0,74
11	75,8	67,61	12	0,24	12	0,59	16	0,91
12	81,8	73,50	14	0,30	14	0,72	16	1,13
13	87,8	79,59	14	0,35	14	0,88	16	1,38
14	93,8	85,61	14	0,41	16	1,02	16	1,64
15	99,8	91,63	14	0,48	16	1,20	16	1,93
16	105,8	97,65	14	0,55	16	1,39	20	2,20
17	111,9	103,67	14	0,63	16	1,60	20	2,54
18	117,9	109,71	14	0,71	16	1,81	20	2,89
19	123,9	115,75	14	0,80	16	2,05	20	3,27
20	130,0	121,78	14	0,89	16	2,30	20	3,67
21	136,0	127,82	16	0,99	20	2,53	20	4,10
22	142,0	133,86	16	1,03	20	2,80	20	4,55
23	148,1	139,90	16	1,20	20	3,09	20	5,02
24	154,1	145,94	16	1,31	20	3,39	20	5,51
25	160,2	152,00	16	1,43	20	3,70	20	6,02
26	166,2	158,04	16	1,56	20	4,03	20	6,56
27	172,3	164,09	16	1,68	20	4,38	20	7,12
28	178,3	170,13	16	1,82	20	4,73	20	7,71
29	184,4	176,19	16	1,96	20	5,10	20	8,31
30	190,4	182,25	16	2,10	20	5,49	20	8,97
31	196,5	188,31	20	2,24	20	5,88	25	9,52
32	202,5	194,35	20	2,39	20	6,30	25	10,19
33	208,6	200,40	20	2,55	20	6,72	25	10,89
34	214,6	206,46	20	2,71	20	7,16	25	11,61
35	220,7	212,52	20	2,88	20	7,61	25	12,35
36	226,8	218,58	20	3,06	25	7,99	25	13,11
37	232,8	224,64	20	3,24	25	8,47	25	13,90
38	238,9	230,69	20	3,42	25	8,96	25	14,70
39	244,9	236,75	20	3,61	25	9,50	25	15,54
40	251,0	242,81	20	3,80	25	9,99	25	16,40
41	258,9	248,87	25	3,98	25	10,51		
42	265,0	254,93	25	4,19	25	11,07	25	18,17
43	271,1	260,98	25	4,38	25	11,63	25	19,09
44	277,1	267,03	25	4,61	25	12,21	25	20,03
45	283,2	273,10	25	4,83	25	12,80	25	21,00
46	289,2	279,16	25	5,05	25	13,40		
47	295,3	285,21	25	5,28	25	14,02	25	23,00
48	301,4	291,27	25	5,52	25	14,65	25	24,04
49	307,4	297,33	25	5,76				
50	313,5	303,39	25	6,00	25	15,95	25	26,17

Z	de	dp	semplici D1 Kg.		doppie D2 Kg.		triple D3 Kg.	
51	319,5	309,45	25	6,25				
52	325,6	315,50	25	6,50	25	17,31	25	28,40
53	331,6	321,56	25	6,77				
54	337,7	327,64	25	7,03	25	18,73	25	30,72
55	343,8	333,70	25	7,30	25	19,45	25	31,91
56	349,8	339,75	25	7,57	25	20,20		
57	355,9	345,81	25	7,85	25	20,95	30	34,28
58	362,0	351,87	25	8,13	25	21,72		
60	374,1	363,99	25	8,72	25	23,30	30	38,12
62	386,2	376,12	25	9,33				
64	398,3	388,24	25	9,95	30	26,62		
65	404,4	394,29	25	10,27	30	27,48	30	45,00
68	422,6	412,49	30	11,24	30	29,00		
70	434,7	424,61	30	11,92	30	32,01	30	52,42
72	446,8	436,74	30	12,63	30	33,92	30	55,55
75	465,0	454,91	30	13,72	30	36,88		
76	471,1	460,99	30	14,09	30	37,90	30	62,09
78	483,2	473,10	30	14,86				
80	495,3	485,22	30	15,65	30	42,10	30	68,98
85	525,6	515,55	30	17,70	30	47,66	30	78,10
90	555,9	545,86	30	19,87	30	53,36	30	87,79
95	586,2	576,17	30	22,18	30	59,80	30	98,04
100	616,6	606,47	30	24,60	30	66,39	30	108,86
110	677,2	667,11	30	29,84				
114	701,4	691,36	30	32,07	30	86,68	30	142,15
120	737,8	727,74	30	35,58			30	157,77
125	768,1	758,05	30	38,63	30	104,50	30	171,41

CORONE PER CATENE A RULLI - DIN 8187 - ISO 606

PLATE WHEELS FOR ROLLER CHAINS - DIN 8187 - ISO 606

1" x 17,02 mm

25,4 x 17,02 mm

Rullo 15,88 mm

16B - 1 - 2 - 3

B1 B2 B3 b1 C r3

16,2 47,7 79,6 15,8 2,5 26

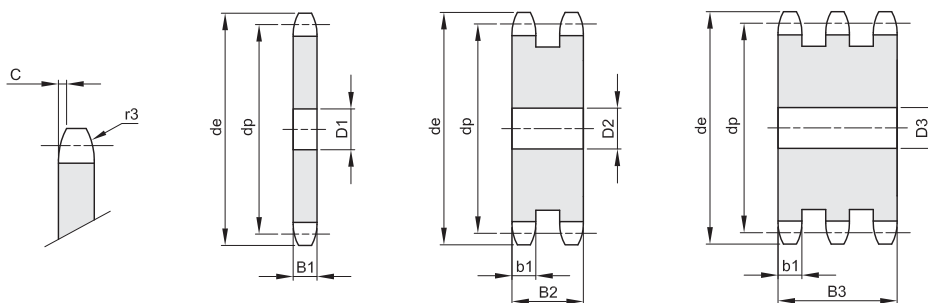

Z	de	dp	semplici D1 Kg.	doppie D2 Kg.	triple D3 Kg.
8	77,9	66,37	16 0,30	16 0,71	16 1,13
9	85,8	74,27	16 0,39	16 0,97	16 1,56
10	93,8	82,19	16 0,51	16 1,27	16 2,05
11	101,7	90,14	16 0,63	20 1,57	20 2,53
12	109,7	98,14	16 0,77	20 1,94	20 3,15
13	117,7	106,12	16 0,92	20 2,36	20 3,84
14	125,7	114,15	16 1,08	20 2,81	20 4,59
15	133,7	122,17	16 1,26	20 3,31	20 5,40
16	141,8	130,20	20 1,43	20 3,84	25 6,16
17	149,8	138,22	20 1,64	20 4,41	25 7,11
18	157,8	146,28	20 1,85	20 5,01	25 8,11
19	165,9	154,33	20 2,08	20 5,66	25 9,18
20	173,9	162,38	20 2,32	20 6,34	25 10,31
21	182,0	170,43	20 2,58	25 7,00	25 11,51
22	190,1	178,48	20 2,84	25 7,76	25 12,77
23	198,1	186,53	20 3,13	25 8,56	25 14,10
24	206,2	194,59	20 3,42	25 9,40	25 14,49
25	214,2	202,66	20 3,73	25 10,28	25 16,94
26	222,3	210,72	20 4,05	25 11,20	30 18,33
27	230,4	218,79	20 4,38	25 12,15	30 19,91
28	238,4	226,85	20 4,73	25 13,14	30 21,55
29	246,5	234,92	20 5,09	25 14,17	30 23,26
30	254,6	243,00	20 5,46	25 15,24	30 25,04
31	262,6	251,08	25 5,82	25 16,35	30 26,88
32	270,7	259,13	25 6,22	25 17,50	30 28,78
33	278,8	267,21	25 6,63	25 18,68	30 30,75
34	286,9	275,28	25 7,06	25 19,90	30 32,78
35	294,9	283,36	25 7,50	25 21,16	30 34,88
36	303,0	291,44	25 7,95	25 22,46	30 37,04
37	311,1	299,51	25 8,41	25 23,80	
38	319,2	307,59	25 8,88	25 25,18	30 41,56
39	327,2	315,67	25 9,37	25 26,59	
40	335,3	323,73	25 9,88	25 28,04	30 46,42
41	345,6	331,82	25 10,39		
42	353,7	339,90	25 10,92	25 31,07	30 51,34
43	361,7	347,98	25 11,46		
44	369,8	356,06	25 12,02	25 34,24	30 56,63
45	377,9	364,12	25 12,60	25 35,89	30 59,36
46	386,0	372,21	25 13,17	25 37,56	30 62,17
47	394,1	380,29	25 13,76		
48	402,1	388,36	25 14,37	25 41,06	30 67,97
49	410,2	396,44	25 14,99		
50	418,3	404,52	25 15,63	25 44,70	30 74,01

Z	de	dp	semplici D1 Kg.	doppie D2 Kg.	triple D3 Kg.
51	426,4	412,60	30 16,25		
52	434,5	420,67	30 16,90	30 48,40	40 79,98
53	442,5	428,75	30 17,58		
54	450,6	436,85	30 18,26		
55	458,7	444,93	30 18,96	30 54,38	40 89,92
56	466,8	453,01	30 19,67	40 56,24	
57	474,9	461,07	30 20,50	40 58,35	40 96,87
58	482,9	469,16	30 21,13		
60	499,1	485,32	30 22,65	40 64,90	40 107,78
62	515,3	501,50	30 24,22	40 69,46	
64	531,4	517,65	30 25,84		
65	539,5	525,73	30 26,67	40 76,59	40 127,24
68	563,8	549,98	30 29,23	40 84,07	
70	579,9	566,14	30 31,01	40 89,24	40 148,31
72	596,1	582,32	30 32,84	40 94,60	40 157,18
75	620,3	606,55	30 35,68	40 102,85	
76	628,4	614,65	30 36,65	40 105,69	40 175,70
78	644,6	630,80	30 38,64		
80	660,7	646,96	30 40,68	40 117,43	40 195,25
85	701,2	687,40	30 46,00	40 132,96	40 221,13
90	741,6	727,81	30 51,65	40 149,46	40 248,61
95	782,0	768,22	30 57,62	40 166,91	40 277,70
100	822,4	808,63	30 63,62	40 181,33	
110	903,3	889,48	30 77,50		
114	935,6	921,82	30 83,31	40 242,01	40 402,85
120	984,1	970,33	30 92,40		
125	1024,5	1010,73	30 100,33	40 291,84	40 485,90

CORONE PER CATENE A RULLI - DIN 8187 - ISO 606

PLATE WHEELS FOR ROLLER CHAINS - DIN 8187 - ISO 606

1"1/4 x 3/4"

31,75 x 19,56 mm
Rullo 19,05 mm
20B - 1 - 2 - 3

B1	B2	B3	b1	C	r3
18,5	54,6	91	18,2	3,5	32

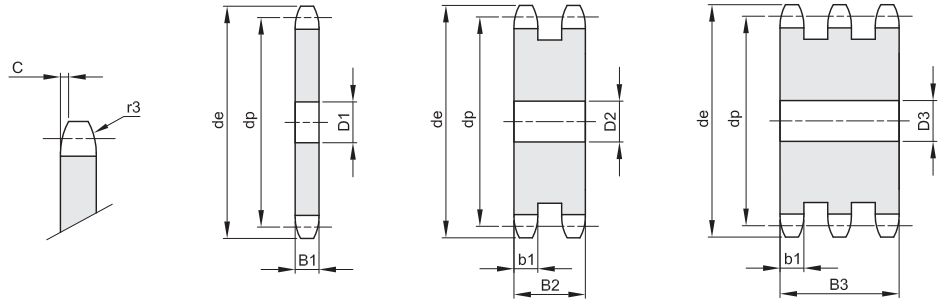

Z	de	dp	semplici D1 Kg.		doppie D2 Kg.		triple D3 Kg.	
8	96,0	82,96	16	0,55	20	1,28	20	2,02
9	106,5	92,84	16	0,73	20	1,74	20	2,79
10	117,0	102,74	16	0,93	20	2,28	20	3,77
11	127,0	112,68	20	1,13	20	2,89	25	4,53
12	137,0	122,68	20	1,38	20	3,56	25	5,64
13	147,5	132,65	20	1,65	20	4,31	25	4,87
14	157,6	142,68	20	1,94	20	5,12	25	8,20
15	167,7	152,72	20	2,26	20	6,00	25	9,65
16	177,7	162,75	20	2,60	30	6,78	30	11,07
17	187,7	172,78	20	2,96	30	7,80	30	12,75
18	197,8	182,85	20	3,34	30	8,89	30	14,54
19	207,9	192,91	20	3,75	30	10,05	30	16,45
20	217,9	202,98	20	4,19	30	11,27	30	18,47
21	228,0	213,04	25	4,62	30	12,56	30	20,62
22	238,1	223,11	25	5,09	30	13,93	30	22,87
23	248,2	233,17	25	5,60	30	15,36	30	25,24
24	258,3	243,23	25	6,18	30	16,86	30	27,72
25	268,4	253,33	25	6,67	30	18,43	30	30,32
26	278,4	263,40	30	7,21	30	20,07	30	33,03
27	288,5	273,48	30	7,81	30	21,77	30	35,86
28	298,5	283,56	30	8,43	30	23,56	30	38,80
29	308,6	293,65	30	9,07	30	25,39		
30	318,7	303,75	30	9,73	30	27,30	30	45,03
31	328,8	313,85	30	10,42	30	29,29		
32	338,9	323,91	30	11,13	30	31,34	30	51,72
33	349,0	334,01	30	11,87				
34	359,1	344,10	30	12,63	30	35,64	30	58,86
35	369,2	354,20	30	13,41	30	37,90	30	62,60
36	379,2	364,30	30	14,22	30	40,22	30	66,46
37	389,3	374,39	30	15,04				
38	399,4	384,49	30	15,90	30	45,08	30	74,52
39	409,5	394,59	30	16,77				
40	419,6	404,66	30	17,67	30	50,21	30	83,04
41	430,7	414,78	30	18,59				
42	440,8	424,88	30	19,54	30	55,62		
43	450,9	434,97	30	20,50				
44	461,0	445,07	30	21,50				
45	471,1	455,17	30	22,51	30	64,25	40	105,96
46	481,2	465,26	30	23,55	30	67,26		
48	501,4	485,46	30	25,70	30	73,49		
50	521,6	505,65	30	27,93	30	80,00	40	132,13
52	541,8	525,84	30	30,27	40	86,55		
54	562,0	546,07	30	32,69				

Z	de	dp	semplici D1 Kg.		doppie D2 Kg.		triple D3 Kg.	
55	572,1	556,16	30	33,94			40	161,16
56	582,2	566,26	30	35,21				
57	592,3	576,36	30	36,51	40	104,71	40	173,58
58	602,4	586,45	30	37,82				
60	622,6	606,65	30	40,53	40	116,43	40	193,06
64	663,0	647,06	30	46,22				
65	673,1	657,16	30	47,70	40	137,34	40	227,83
70	723,6	707,67	30	55,45	40	159,97	40	265,46
75	774,2	758,19	30	63,79				
76	784,3	768,32	30	66,53	40	189,39	40	314,39
80	824,7	808,72	30	72,71	40	210,38		
85	875,2	859,25	30	82,21				
90	925,7	909,76	30	92,30				
95	976,2	960,28	30	102,96	40	298,90		
100	1026,7	1010,79	40	114,13				
114	1168,2	1152,26	40	148,73	40	433,24	40	720,16

CORONE PER CATENE A RULLI - DIN 8187 - ISO 606

PLATE WHEELS FOR ROLLER CHAINS - DIN 8187 - ISO 606

1"1/2 x 1"

38,1 x 25,4 mm
Rullo 25,4 mm
24B - 1 - 2 - 3

B1	B2	B3	b1	C	r3
24,1	72	120,3	23,6	4	38

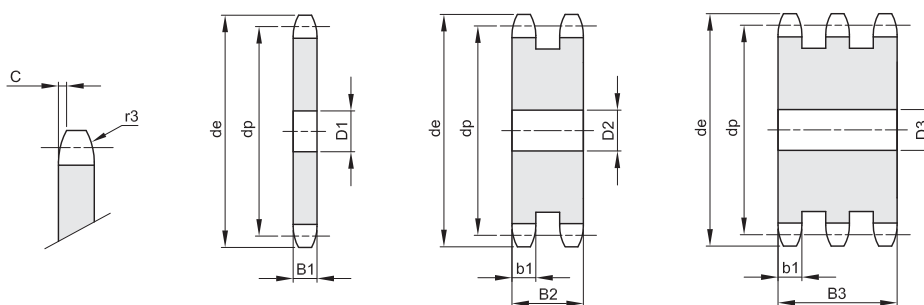

Z	de	dp	semplici D1	Kg.	doppie D2	Kg.	triple D3	Kg.
8	113,0	99,55	20	1,00	25	2,31	25	3,67
9	125,0	111,40	20	1,32	25	3,18	25	5,10
10	137,0	123,29	20	1,69	25	4,19	25	6,75
11	149,0	135,21	25	2,07	25	5,33	30	8,42
12	161,0	147,22	25	2,53	25	6,59	30	10,50
13	173,0	159,18	25	3,03	25	7,99	30	12,81
14	185,0	171,22	25	3,57	25	9,52	30	15,33
15	197,0	183,26	25	4,16	25	11,18	30	18,08
16	209,0	195,30	25	4,79	30	12,85	30	21,04
17	221,0	207,34	25	5,47	30	14,77	30	24,22
18	233,0	219,42	25	6,19	30	16,82	30	27,61
19	245,5	231,49	25	6,95	30	19,00	30	31,23
20	257,5	243,57	25	7,76	30	21,31	30	35,06
21	270,5	255,65	30	8,57	30	23,75	40	38,60
22	282,5	267,73	30	9,46	30	26,33	40	42,87
23	294,5	279,80	30	10,40	30	29,03	40	47,36
24	307,0	291,88	30	11,38	30	31,86	40	52,07
25	319,0	304,00	30	12,41	30	34,83	40	56,99
26	331,0	316,08	30	13,47	30	37,93	40	62,14
27	343,0	328,19	30	14,59	30	41,15	40	67,50
28	355,0	340,27	30	15,74	30	44,51	40	73,08
29	367,5	352,38	30	16,94	30	48,00		
30	379,5	364,50	30	18,91	30	51,61	40	84,90
31	391,5	376,62	30	19,47	40	55,05		
32	403,5	388,69	30	20,80	40	58,93	40	97,59
33	415,5	400,81	30	22,18	40	62,94		
34	428,0	412,93	30	23,60	40	67,08		
35	440,0	425,04	30	25,06	40	71,35	40	118,26
36	452,0	437,16	30	26,60	40	75,75		
37	464,0	449,27	30	28,12	40	80,28		
38	476,5	461,39	30	29,71	40	84,95	40	140,90
40	501,5	485,62	30	33,03	40	94,66	40	158,08
41	513,5	497,74	30	34,75				
42	525,5	509,85	30	36,52	40	104,90		
45	562,0	546,20	30	42,08	40	121,24	40	201,37
46	574,0	558,32	30	44,03				
48	598,5	582,55	30	48,04	40	138,75	40	230,56
50	622,5	606,78	30	52,24	40	151,08	40	251,11
52	647,0	631,01	30	56,60				
54	671,0	655,25	30	61,14				
55	683,5	667,40	30	63,48				
56	695,5	679,50	30	65,86				
57	707,5	691,63	30	68,28	40	198,34	40	329,92

Z	de	dp	semplici D1	Kg.	doppie D2	Kg.	triple D3	Kg.
60	745,0	727,97	30	75,82	40	220,55	40	366,97
62	769,0	752,24	40	80,95				
65	805,5	788,59	40	89,14	40	260,19		
70	866,0	849,21	40	103,77				
76	939,0	921,98	40	122,54	40	358,88	40	597,76
80	987,5	970,44	40	135,99				
85	1048,0	1031,10	40	153,79				
95	1169,0	1152,33	40	192,67	40	583,00		

CORONE PER CATENE A RULLI - DIN 8187 - ISO 606

PLATE WHEELS FOR ROLLER CHAINS - DIN 8187 - ISO 606

1"3/4 x 1"1/4

44,45 x 30,99 mm

Rullo 27,94 mm

28B - 1 - 2 - 3

B1	B2	B3	b1	C	r3
29,4	88,4	148	28,8	5	44

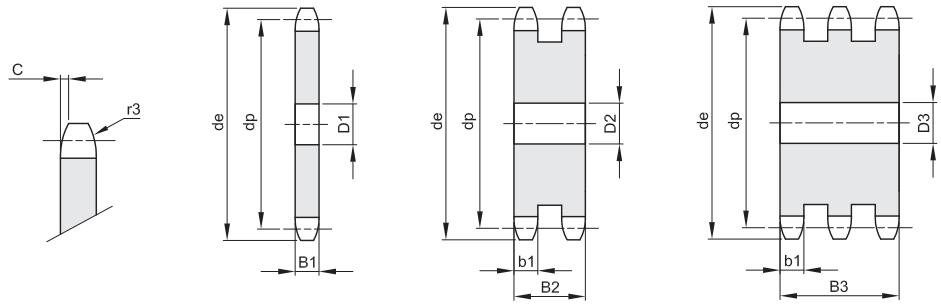

Z	de	dp	semplici		doppie		triple	
			D1	Kg.	D2	Kg.	D3	Kg.
8	132,0	116,15	20	1,71	25	4,01	25	6,39
9	146,0	129,96	20	2,26	25	5,48	25	8,80
10	160,0	143,85	20	2,88	25	7,17	25	11,56
11	174,0	157,77	25	3,53	30	8,92	30	14,44
12	188,0	171,74	25	4,29	30	11,04	30	17,93
13	204,0	185,75	25	5,12	30	13,38	30	21,79
14	218,0	199,76	25	6,03	30	15,94	30	26,02
15	232,0	213,79	25	7,01	30	18,72	30	30,61
16	246,0	227,84	30	8,02	30	21,71	30	35,57
17	260,0	241,90	30	9,14	30	24,92	30	40,89
18	274,0	255,98	30	10,34	30	28,36	30	46,58
19	289,0	270,06	30	11,61	30	32,00	30	52,64
20	303,0	284,15	30	12,95	30	35,87	30	59,06
21	317,0	298,24	30	14,37	30	39,96	40	65,20
22	331,0	312,34	30	15,86	30	44,26		
23	345,0	326,44	30	17,42	30	48,78	40	79,87
24	359,0	340,55	30	19,05				
25	373,0	354,66	30	20,76	30	58,50	40	95,99
26	387,0	368,77	30	22,54	40	63,28		
27	401,0	382,88	30	24,39				
28	416,0	397,00	30	26,32	40	74,29		
30	444,0	425,24	30	30,38	40	86,17	40	142,70
32	472,0	453,49	30	34,74				
34	500,0	481,75	30	39,38				
35	514,0	495,88	30	41,82	40	119,69		
36	529,0	510,01	30	44,32				
38	557,0	538,27	30	49,55	40	142,42	40	236,43
40	585,0	566,54	30	55,07	40	158,67	40	263,52
45	656,0	637,22	30	70,13	40	203,10	40	337,73
50	726,0	707,91	30	87,01	40	252,99		
57	825,0	806,90	40	113,56	40	332,00	40	552,76
60	869,0	849,32	40	126,08				
76	1095,0	1075,62	40	203,89	40	600,35	40	1000,97

Z	de	dp	semplici		doppie		triple	
			D1	Kg.	D2	Kg.	D3	Kg.

CORONE PER CATENE A RULLI - DIN 8187 - ISO 606

PLATE WHEELS FOR ROLLER CHAINS - DIN 8187 - ISO 606

2" x 1"1/4

50,8 x 30,99 mm

Rullo 29,21 mm

32B - 1 - 2 - 3

B1	B2	B3	b1	C	r3
-----------	-----------	-----------	-----------	----------	-----------

29,4	87,4	146	28,8	6	51
------	------	-----	------	---	----

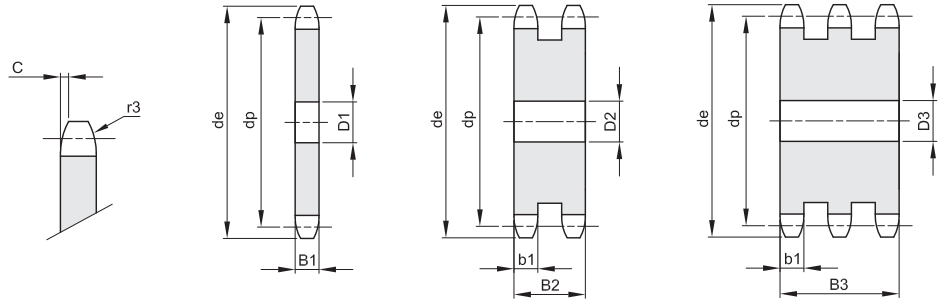

Z	de	dp	semplici D1		doppie D2		triple D3	
			Kg.		Kg.		Kg.	
8	152,0	132,74	25	2,27	25	5,53	25	8,83
9	168,0	148,54	25	2,99	25	7,46	25	11,99
10	184,0	164,39	25	3,81	25	9,68	25	15,63
11	200,0	180,31	30	4,67	35	11,86	35	19,20
12	216,0	196,29	30	5,67	35	14,64	35	23,78
13	235,0	212,29	30	6,77	35	17,70	35	28,83
14	251,0	228,29	30	7,97	35	21,05	35	34,35
15	267,0	244,30	30	9,26	35	24,68	35	40,34
16	283,0	260,40	30	10,64	40	28,38	40	46,47
17	299,0	276,46	30	12,12	40	32,57	40	53,40
18	315,0	292,55	30	13,69	40	37,05	40	60,80
19	331,0	308,66	30	15,36	40	41,80	40	68,68
20	347,0	324,71	40	16,99	40	46,84	40	77,02
21	363,0	340,82	40	18,85	40	52,15	40	85,84
22	379,0	356,98	40	20,80	40	57,75		
23	396,0	373,08	40	22,85	40	63,63	40	104,88
24	412,0	389,18	40	24,99	40	69,80		
25	428,0	405,33	40	27,23	40	76,24	40	125,81
26	444,0	421,44	40	29,56	40	82,97		
28	476,0	453,69	40	34,51	40	97,27		
30	508,0	486,00	40	39,84	40	112,70	40	186,37
32	541,0	518,27	40	45,54				
35	589,0	566,71	40	54,81	40	156,19	40	258,69
38	638,0	615,16	40	64,93	40	185,67	40	307,73
40	670,0	647,47	40	72,16	40	206,73		
45	751,0	728,24	40	91,87	40	265,32	40	438,64
50	832,0	809,04	40	113,96	40	328,95	40	549,27
57	945,0	922,16	40	148,86	40	431,27	40	716,72
60	993,0	970,65	40	165,24				
76	1252,0	1229,27	40	267,00	40	757,78	40	1295,64

Z	de	dp	semplici D1		doppie D2		triple D3	
			Kg.		Kg.		Kg.	

CORONE DOPPIE PER DUE CATENE SEMPLICI - DIN 8187 - ISO 606

DOUBLE SIMPLE SPROCKETS - DIN 8187 - ISO 606

3/8" x 7/32"
9,525 x 5,72 mm
 Rullo 6,35 mm
06B - 1

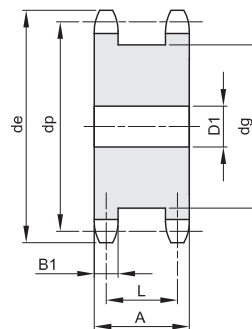
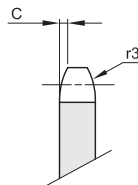

B1	C	r3
5,3	1	10

Materiale acciaio C45

Z	de	dp	D1	dg	A	L	Kg.
13	43,5	39,80	10	29	23	17,8	0,14
14	46,5	42,80	10	32	23	17,8	0,17
15	49,5	45,81	10	35	23	17,8	0,20
16	52,5	48,82	12	38	23	17,8	0,23
17	55,5	51,83	12	41	23	17,8	0,26
18	58,6	54,85	12	44	23	17,8	0,30
19	61,6	57,87	12	47	23	17,8	0,34
20	64,6	60,89	15	50	23	17,8	0,38
21	67,6	63,91	15	53	23	17,8	0,43
23	73,7	69,95	15	60	23	17,8	0,54
25	79,7	76,00	15	66	23	17,8	0,65

1/2" x 5/16"
12,7 x 7,75 mm
 Rullo 8,51 mm
08B - 1

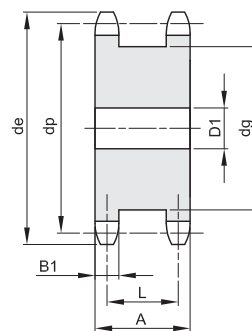
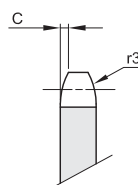

B1	C	r3
7,2	1,3	13

Materiale acciaio C45

Z	de	dp	D1	dg	A	L	Kg.
12	53,9	49,07	15	36	30	23	0,27
13	57,9	53,06	15	40	30	23	0,33
14	61,9	57,07	15	44	30	23	0,40
15	65,9	61,09	15	48	30	23	0,47
16	69,9	65,10	15	52	30	23	0,55
17	74,0	69,11	15	56	30	23	0,64
18	78,0	73,14	15	60	30	23	0,73
19	82,0	77,16	15	64	30	23	0,84
20	86,0	81,19	15	68	30	23	0,93
21	90,1	85,22	15	72	30	23	1,03
23	98,1	93,27	15	80	30	23	1,28
25	106,2	101,33	15	88	30	23	1,54

CORONE DOPPIE PER DUE CATENE SEMPLICI - DIN 8187 - ISO 606

DOUBLE SIMPLE SPROCKETS - DIN 8187 - ISO 606

5/8" x 3/8"

15,875 x 9,65 mm
Rullo 10,16 mm
10B - 1

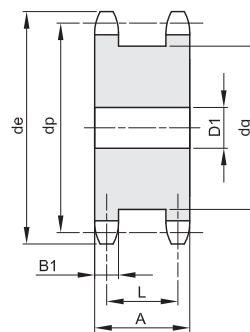
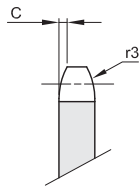

B1	C	r3
----	---	----

9,1	1,6	16
-----	-----	----

Materiale acciaio C45

Z	de	dp	D1	dg	A	L	Kg.
12	68,2	61,34	15	45	34	25,2	0,51
13	73,2	66,32	15	50	34	25,2	0,62
14	78,2	71,34	15	55	34	25,2	0,74
15	83,2	76,36	15	60	34	25,2	0,87
16	88,3	81,37	15	65	34	25,2	1,02
17	93,3	86,39	15	70	34	25,2	1,17
18	98,3	91,42	15	75	34	25,2	1,34
19	103,3	96,45	20	80	34	25,2	1,49
20	108,4	101,49	20	85	34	25,2	1,68
21	113,4	106,52	20	90	34	25,2	1,88
23	123,5	116,58	20	100	34	25,2	2,30
25	133,6	126,66	20	110	34	25,2	2,77

3/4" x 7/16"

19,05 x 11,68 mm
Rullo 12,07 mm
12B - 1

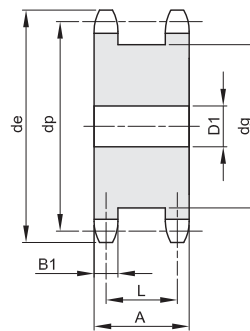
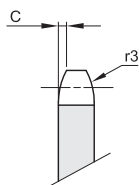

B1	C	r3
----	---	----

11,1	2	19
------	---	----

Materiale acciaio C45

Z	de	dp	D1	dg	A	L	Kg.
12	81,8	73,60	20	53	44	33,4	0,91
13	87,8	79,59	20	59	44	33,4	1,12
14	93,8	85,61	20	65	44	33,4	1,33
15	99,8	91,63	20	71	44	33,4	1,57
16	105,8	97,65	20	77	44	33,4	1,84
17	111,9	103,67	20	83	44	33,4	2,12
18	117,9	109,71	20	89	44	33,4	2,42
19	123,9	115,75	20	95	44	33,4	2,75
20	130,0	121,78	20	101	44	33,4	3,09
21	136,0	127,82	25	107	44	33,4	3,42
23	148,1	139,90	25	119	44	33,4	4,21
25	160,2	152,00	25	131	44	33,4	5,07

CORONE DOPPIE PER DUE CATENE SEMPLICI - DIN 8187 - ISO 606

DOUBLE SIMPLE SPROCKETS - DIN 8187 - ISO 606

1" x 17,02 mm
25,4 x 17,02 mm
Rullo 15,88 mm
16B - 1

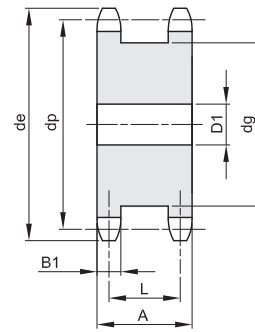
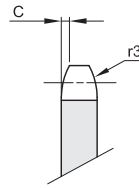

B1	C	r3
16,2	2,5	26

Materiale acciaio C45

Z	de	dp	D1	dg	A	L	Kg.
12	109,7	98,14	20	72	68	52,5	2,58
13	117,7	106,12	20	80	68	52,5	3,14
14	125,7	114,15	20	88	68	52,5	3,76
15	133,7	122,17	20	96	68	52,5	4,44
16	141,8	130,20	25	104	68	52,5	5,09
17	149,8	138,22	25	112	68	52,5	5,87
18	157,8	146,28	25	120	68	52,5	6,70
19	165,9	154,33	30	128	68	52,5	7,53
21	182,0	170,43	30	144	68	52,5	9,48

PIGNONI TENDICATENA COMPLETI DI CUSCINETTO A SFERE CHAIN-STRETCHER SPROCKETS WITH BALL BEARING

I pignoni tendicatena vengono forniti pronti per il montaggio. Sono composti da una ruota dentata montata su un cuscinetto a sfere a doppio schermo di protezione che garantisce una maggiore resistenza all'usura. Il cuscinetto a sfere non richiede manutenzione. Le ruote sono in materiale C45 e dentate secondo riferimento DIN 8187, ISO 606.

I cuscinetti possono operare ad una temperatura da -20°C a $+120^{\circ}\text{C}$.

Our chain-stretcher sprockets with ball bearing are supplied "ready for mounting". They consist of a toothed wheel mounted on a ball bearing with double protection shield that guarantee a high resistance against break-age and wear. Bearing requires no maintenance.

The wheels are in C45 steel and they are toothed according to DIN 8187, ISO 606. The ball bearing can operate at a temperature from -20°C to $+120^{\circ}\text{C}$.

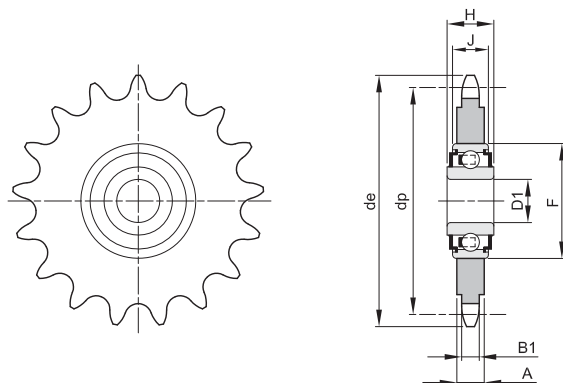

Materiale acciaio C45

Z	passo	ISO	De	Dp	B1	A	D1	F	H	J	Kg.
23	8 x 1/8"	05B-1	62,2	58,75	2,8	7,0	16 ^{+0,26} _{+0,13}	40	18,3	12	0,13
21	3/8" x 7/32"	06B-1	67,6	63,91	5,3	5,3	16 ^{+0,26} _{+0,13}	40	18,3	12	0,15
22	3/8" x 7/32"	06B-1	70,6	66,93	5,3	5,3	16 ^{+0,26} _{+0,13}	40	18,3	12	0,16
18	1/2" x 1/8"	081-1	79,4	73,14	3,0	7,0	16 ^{+0,26} _{+0,13}	40	18,3	12	0,18
15	1/2" x 3/16"	083-1	67,4	61,09	4,5	7,0	16 ^{+0,26} _{+0,13}	40	18,3	12	0,16
16	1/2" x 3/16"	083-1	71,4	65,10	4,5	7,0	16 ^{+0,26} _{+0,13}	40	18,3	12	0,17
18	1/2" x 3/16"	083-1	79,4	73,14	4,5	7,0	16 ^{+0,26} _{+0,13}	40	18,3	12	0,20
14	1/2" x 5/16"	08B-1	61,9	57,07	7,2	7,2	16 ^{+0,26} _{+0,13}	40	18,3	12	0,13
16	1/2" x 5/16"	08B-1	69,9	65,10	7,2	7,2	16 ^{+0,26} _{+0,13}	40	18,3	12	0,17
18	1/2" x 5/16"	08B-1	78,0	73,14	7,2	7,2	16 ^{+0,26} _{+0,13}	40	18,3	12	0,22
14	5/8" x 3/8"	10B-1	78,2	71,34	9,1	9,1	16 ^{+0,26} _{+0,13}	40	18,3	12	0,23
15	5/8" x 3/8"	10B-1	83,2	76,36	9,1	9,1	16 ^{+0,26} _{+0,13}	40	18,3	12	0,27
17	5/8" x 3/8"	10B-1	93,3	86,39	9,1	9,1	16 ^{+0,26} _{+0,13}	40	18,3	12	0,36
13	3/4" x 7/16"	12B-1	87,8	79,59	11,1	11,1	16 ^{+0,26} _{+0,13}	40	18,3	12	0,34
15	3/4" x 7/16"	12B-1	99,8	91,63	11,1	11,1	16 ^{+0,26} _{+0,13}	40	18,3	12	0,47
12	1" x 17,02	16B-1	109,7	98,14	16,2	16,2	20 ^{+0,10} ₋₀	47	17,7	14	0,72
13	1"1/4 x 3/4"	20B-1	147,7	132,67	18,5	18,5	25 ^{+0,10} ₋₀	52	21	15	1,64

ELEMENTI DI FISSAGGIO PER PIGNONI TENDICATENA LOCKING PARTS FOR CHAIN STRETCHER SPROCKETS

Gli Elementi di fissaggio per tendicatena sono stati realizzati per facilitare e velocizzare il montaggio del Pignone Tendicatena.

Il set degli elementi è composto da: una vite con testa cava esagonale, una bussola per la guida del foro, un dado esagonale autobloccante.

The Locking Parts have been presented to make easier and faster the mounting of Chain Stretcher Sprockets.

Elements set: Exagonal head screw, hole guide bush, self-locking exagonal nut.

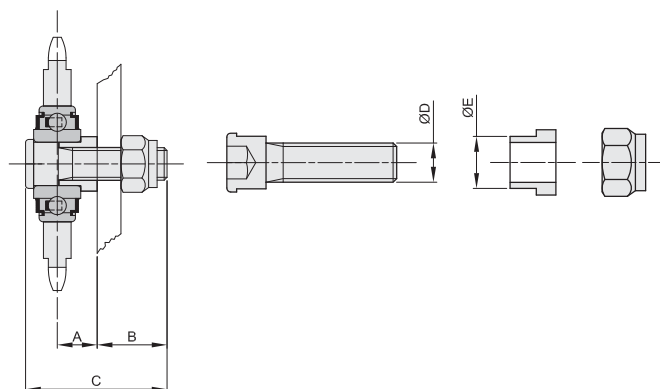

codice	A	B	C	ØD	ØE	Kg
EFT-1	15	25	52	M12	16	0,08
EFT-2	25	28	66	M16	20	0,16

RUOTE PER CATENE A CERNIERA - DIN 8153 WHEELS FOR TABLE TOP CHAINS - DIN 8153

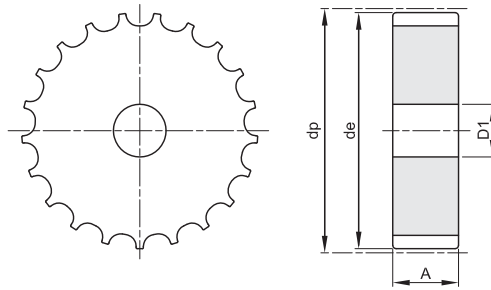

Materiale acciaio C45

Z	passo	de	dp	D1	A	Kg.
15	1"1/2 (38,1)	92,9	93,7	16	43,5	1,86
17	1"1/2 (38,1)	104,7	105,5	16	43,5	2,34
19	1"1/2 (38,1)	116,6	117,3	16	43,5	3,10
21	1"1/2 (38,1)	129,7	129,2	20	43,5	3,79
23	1"1/2 (38,1)	141,6	141,2	20	43,5	4,46
25	1"1/2 (38,1)	153,6	153,2	20	43,5	5,50
27	1"1/2 (38,1)	165,6	165,2	20	43,5	6,31
29	1"1/2 (38,1)	177,7	177,2	20	43,5	7,31
31	1"1/2 (38,1)	189,7	189,3	20	43,5	8,63

PIGNONI TENDICATENA CON SFERE E VITE DI FISSAGGIO CHAIN-STRETCHER SPROCKETS WITH BALLS AND FASTENING BOLT

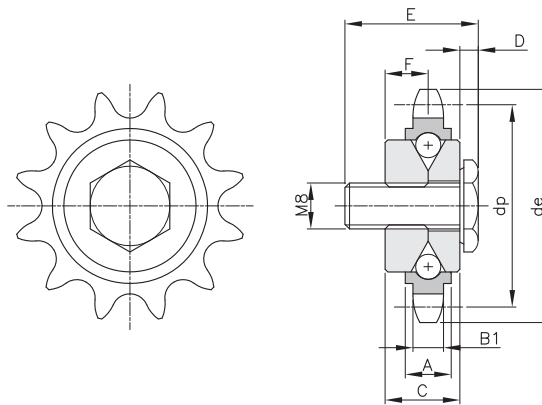

Materiale acciaio C 10 Cementato e Temperato

Z	passo	de	dp	A	B1	C	D	E	F	Kg.
12	3/8" x 5/32"	40	36,80	7	3,5	11,7	3	23	7,2	0,06
10	1/2" x 1/8"	46	41,10	7	3	11,7	3	23	7,2	0,06
10	1/2" x 3/16"	46	41,10	7	4,5	11,7	3	23	7,2	0,07

RUOTE LIBERE SEMPLICI SIMPLEX FREE WHEELS

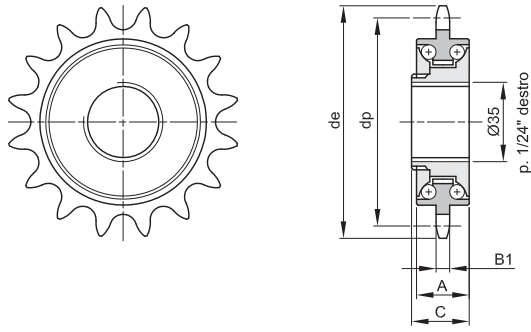

Z	passo	de	dp	B1	A	C	Kg.
16	1/2" x 1/8"	71,4	65,10	3	14	15	0,14
18	1/2" x 1/8"	79,4	73,14	3	14	15	0,15

RUOTE LIBERE INDUSTRIALI INDUSTRIAL FREE WHEELS

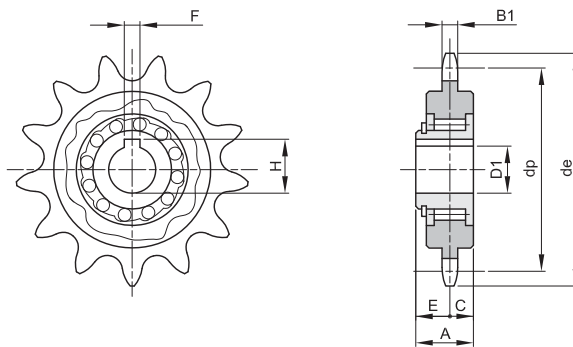

Materiale acciaio 18NiCrMo5 Cementato e Temperato

Z	passo	de	dp	A	C	E	B1	D1	F	H	Kg.
13	1/2" x 1/8"	59,4	53,06	14,8	6	8,8	3	12	4	13,7	0,12

MOZZI SALDABILI PER BUSSOLA CONICA

WELD - ON HUBS FOR TAPER BUSHES

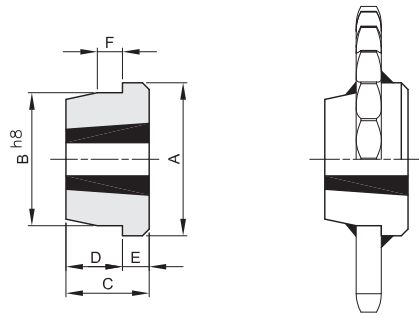

Materiale Fe

codice	bussola	A	B	C	D	E	F	Kg.
MSC	1210	73	60	25	16	9	10	0,31
MSC	1215	73	60	38	22	16	11	0,50
MSC	1610	83	70	25	16	9	10	0,37
MSC	1615	83	70	38	22	16	11	0,60
MSC	2012	96	90	32	22	10	12	0,72
MSC	2517	127	110	45	26	19	13	1,80
MSC	3020	152	130	51	27	24	18	2,59
MSC	3030	152	130	76	51	25	19	3,55
MSC	3525	184	155	65	40	25	25	7,30
MSC	3535	184	155	89	57	32	25	6,40
MSC	4040	225	195	102	70	32	35	13,22
MSC	4545	254	220	114	76	38	40	19,30
MSC	5050	276	242	127	89	38	40	24,52

CORONE PER CATENE A RULLI - DIN 8188 - ISO 606 - ANSI B 29.1
PLATE WHEELS FOR ROLLER CHAINS - DIN 8188 - ISO 606 - ANSI B 29.1

ASA 40

12,7 x 7,95 mm
Rullo 7,95 mm
08A - 1

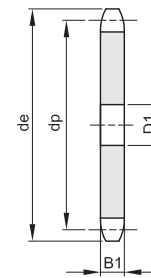
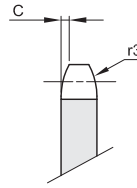

B1	B2	B3	b1	C	r3
7,2				1,6	13,5

Z	de	dp	semplici D1	Kg.	doppie D2	Kg.	triple D3	Kg.
8	39,3	33,18						
9	43,2	37,13						
10	47,2	41,10	8	0,06				
11	51,2	45,07						
12	55,2	49,07						
13	59,2	53,06	10	0,10				
14	63,2	57,07						
15	67,2	61,09						
16	71,2	65,10						
17	75,2	69,11	10	0,18				
18	79,2	73,14						
19	83,3	77,16	10	0,23				
20	87,3	81,19	10	0,27				
21	91,3	85,22	12	0,28				
22	95,4	89,24						
23	99,4	93,27						
24	103,4	97,29	12	0,38				
25	107,4	101,33						
26	111,5	105,36						
27	115,5	109,40						
28	119,5	113,42						
29	123,6	117,46						
30	127,6	121,50	16	0,58				
31	131,6	125,54						
32	135,7	129,56	16	0,68				
33	139,7	133,60						
34	143,8	137,64	16	0,78				
35	147,8	141,68	16	0,83				
36	151,8	145,72						
37	155,9	149,76						
38	159,9	153,80	16	0,98				
39	163,9	157,83						
40	168,0	161,87						
41	172,5	165,91						
42	176,6	169,95						
43	180,6	173,99						
44	184,6	178,03	20	1,32				
45	188,7	182,07						
46	192,7	186,10						
47	196,8	190,14						
48	200,8	194,18	20	1,58				
49	204,8	198,22						
50	208,9	202,26	20	1,73				

Z	de	dp	semplici D1	Kg.	doppie D2	Kg.	triple D3	Kg.
51	212,9	206,30						
52	217,0	210,34						
53	221,0	214,37						
54	225,0	218,43						
55	229,1	222,46						
56	233,1	226,50						
57	237,2	230,54	20	2,25				
58	241,2	234,62						
59	245,2	238,62						
60	249,3	242,66						
62	257,4	250,74						
64	265,4	258,82						
65	269,5	262,86						
66	273,5	266,90						
68	281,6	274,99						
70	289,7	283,07						
72	297,8	291,16						
75	309,9	303,27						
76	313,9	307,33						
78	322,0	315,40						
80	330,1	323,48						
85	350,3	343,69						
90	370,5	363,90						
95	390,7	384,11						
100	410,9	404,31						
110	451,4	444,74						
114	467,5	460,90						
120	491,8	485,16						
125	512,0	505,37						

CORONE PER CATENE A RULLI - DIN 8188 - ISO 606 - ANSI B 29.1
PLATE WHEELS FOR ROLLER CHAINS - DIN 8188 - ISO 606 - ANSI B 29.1

ASA 50

15,875 x 9,53 mm
Rullo 10,16 mm
10A - 1

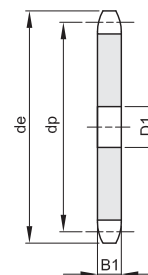
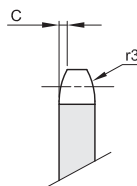

B1	B2	B3	b1	C	r3
8,7				2	17

Z	de	dp	semplici D1	doppie D2	triple D3
			Kg.	Kg.	Kg.
8	48,4	41,48	10	0,06	
9	53,3	46,42	10	0,09	
10	58,3	51,37	10	0,11	
11	63,2	56,34	10	0,14	
12	68,2	61,34	10	0,17	
13	73,2	66,32	10	0,20	
14	78,2	71,34	12	0,23	
15	83,2	76,36	12	0,27	
16	88,3	81,37	12	0,31	
17	93,3	86,39	12	0,36	
18	98,3	91,42	12	0,41	
19	103,3	96,45	12	0,46	
20	108,4	101,49	12	0,51	
21	113,4	106,52	12	0,57	
22	118,4	111,55	12	0,62	
23	123,5	116,58	12	0,68	
24	128,5	121,62	12	0,75	
25	133,6	126,66	12	0,82	
26	138,6	131,70	16	0,88	
27	143,6	136,75	16	0,95	
28	148,7	141,78	16	1,03	
29	153,7	146,83	16	1,11	
30	158,8	151,87	16	1,19	
31	163,8	156,92	16	1,28	
32	168,9	161,95	16	1,36	
33	173,9	167,00	16	1,45	
34	178,9	172,05	16	1,55	
35	184,0	177,10	16	1,64	
36	189,0	182,15	20	1,73	
37	194,1	187,20	20	1,83	
38	199,1	192,24	20	1,94	
39	204,2	197,29	20	2,05	
40	209,2	202,34	20	2,16	
41	215,8	207,39	20	2,28	
42	220,8	212,44	20	2,39	
43	225,9	217,49	20	2,50	
44	230,9	222,53	20	2,63	
45	236,0	227,58	20	2,75	
46	241,0	232,63	20	2,88	
47	246,1	237,68	20	3,00	
48	251,1	242,73	20	3,14	
49	256,2	247,78	20	3,28	
50	261,2	252,82	20	3,42	

Z	de	dp	semplici D1	doppie D2	triple D3
			Kg.	Kg.	Kg.
51	266,3	257,87	20	3,56	
52	271,3	262,92	20	3,70	
53	276,4	267,97	20	3,85	
54	281,4	273,03	20	4,00	
55	286,5	278,08	20	4,15	
56	291,5	283,13	25	4,30	
57	296,6	288,18	25	4,46	
58	301,6	293,23	25	4,62	
59	306,7	298,27			
60	311,7	303,32	25	4,95	
62	321,8	313,43	25	5,30	
64	331,9	323,53	25	5,65	
65	337,0	328,58	25	5,83	
68	352,1	343,74	25	6,40	
70	362,2	353,84	25	6,79	
72	372,3	363,95	25	7,19	
75	387,5	379,09	25	7,81	
76	392,5	384,16	25	8,02	
78	402,6	394,25	25	8,46	
80	412,7	404,35	25	8,91	
85	438,0	429,62	30	10,06	
90	463,3	454,88	30	11,30	
95	488,5	480,14	30	12,61	
100	513,8	505,40	30	13,99	
110	564,3	555,92	30	16,97	
114	584,5	576,13	30	19,98	
120	614,8	606,44	30	22,17	
125	640,1	631,71	30	24,08	

CORONE PER CATENE A RULLI - DIN 8188 - ISO 606 - ANSI B 29.1
PLATE WHEELS FOR ROLLER CHAINS - DIN 8188 - ISO 606 - ANSI B 29.1

ASA 60

19,05 x 12,7 mm
Rullo 11,91 mm
12A - 1

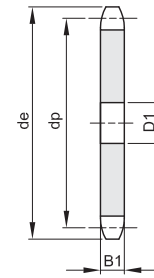
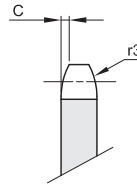

B1	B2	B3	b1	C	r3
11,6				2,4	20

Z	de	dp	semplici D1 Kg.		doppie D2 Kg.		triple D3 Kg.	
8	58,1	49,78						
9	64,0	55,70						
10	70,0	61,64						
11	76,0	67,61						
12	81,9	73,60						
13	87,9	79,59	14	0,35				
14	94,0	85,61	14	0,41				
15	100,0	91,63	14	0,48				
16	106,0	97,65	14	0,55				
17	112,0	103,67	14	0,63				
18	118,0	109,71	14	0,71				
19	124,1	115,75						
20	130,1	121,78	14	0,92				
21	136,2	127,82	16	0,99				
22	142,2	133,86	16	1,09				
23	148,2	139,90	16	1,20				
24	154,3	145,94						
25	160,3	152,00	16	1,43				
26	166,4	158,04	16	1,56				
27	172,4	164,09	16	1,68				
28	178,5	170,13	16	1,82				
29	184,5	176,19	16	1,96				
30	190,6	182,25	16	2,10				
31	196,6	188,31	20	2,24				
32	202,7	194,35	20	2,39				
33	208,8	200,40						
34	214,8	206,46	20	2,71				
35	220,9	212,52	20	2,88				
36	226,9	218,58	20	3,06				
37	233,0	224,64						
38	239,0	230,69	20	3,42				
39	245,1	236,75						
40	251,1	242,81	20	3,85				
41	259,1	248,87						
42	265,2	254,93	25	4,19				
43	271,2	260,98						
44	277,3	267,03						
45	283,3	273,10						
46	289,4	279,16						
47	295,5	285,21						
48	301,5	291,27						
49	307,6	297,33						
50	313,6	303,39						

Z	de	dp	semplici D1 Kg.		doppie D2 Kg.		triple D3 Kg.	
51	319,7	309,45						
52	325,8	315,50						
53	331,8	321,56						
54	337,9	327,64						
55	343,9	333,70						
56	350,0	339,75						
57	356,1	345,81						
58	362,1	351,87						
59	368,2	357,93						
60	374,2	363,99						
62	386,4	376,12						
64	398,5	388,24						
65	404,5	394,29						
66	410,6	400,35						
68	422,7	412,49						
70	434,9	424,60						
72	447,0	436,74						
75	465,2	454,91						
76	471,2	460,99						
78	483,3	473,10						
80	495,5	485,22						
85	525,8	515,55						
90	556,1	545,86						
95	586,4	576,17						
100	616,7	606,47						
110	677,4	667,11						
114	701,6	691,36						
120	738,0	727,74						
125	768,3	758,05						

CORONE PER CATENE A RULLI - DIN 8188 - ISO 606 - ANSI B 29.1

PLATE WHEELS FOR ROLLER CHAINS - DIN 8188 - ISO 606 - ANSI B 29.1

ASA 80

25,4 x 15,88 mm
Rullo 15,88 mm
16A - 1

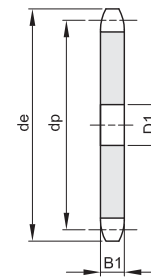
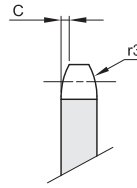

B1	B2	B3	b1	C	r3
14,6				3,2	27

Z	de	dp	semplici D1	Kg.	doppie D2	Kg.	triple D3	Kg.
8	77,9	66,37						
9	85,8	74,27						
10	93,8	82,19						
11	101,7	90,14						
12	109,7	98,14	16	0,77				
13	117,7	106,12						
14	125,7	114,15	16	1,01				
15	133,7	122,17						
16	141,8	130,20	20	1,43				
17	149,8	138,22	20	1,64				
18	157,8	146,28	20	1,85				
19	165,9	154,33	20	2,08				
20	173,9	162,38	20	2,12				
21	182,0	170,43	20	2,45				
22	190,1	178,48	20	2,84				
23	198,1	186,53	20	3,13				
24	206,2	194,59	20	3,42				
25	214,2	202,66						
26	222,3	210,72	20	4,05				
27	230,4	218,79						
28	238,4	226,85	20	4,73				
29	246,5	234,92	20	5,09				
30	254,6	243,00	20	5,46				
31	262,6	251,08						
32	270,7	259,13						
33	278,8	267,21	25	6,63				
34	286,9	275,28	25	7,06				
35	294,9	283,36	25	7,49				
36	303,0	291,44						
37	311,1	299,51						
38	319,2	307,59	25	8,88				
39	327,2	315,67						
40	335,3	323,73						
41	345,6	331,82						
42	353,7	339,90						
43	361,7	347,98						
44	369,8	356,06						
45	377,9	364,12						
46	386,0	372,21						
47	394,1	380,29						
48	402,1	388,36						
49	410,2	396,44						
50	418,3	404,52						

Z	de	dp	semplici D1	Kg.	doppie D2	Kg.	triple D3	Kg.
51	426,5	412,60						
52	434,5	420,67						
53	442,5	428,75						
54	450,6	436,85						
55	458,7	444,93						
56	466,8	453,01						
57	474,9	461,07						
58	482,9	469,16						
59	491,0	477,24						
60	499,1	485,32						
62	515,3	501,50						
64	531,4	517,65						
65	539,5	525,73						
66	547,6	533,80						
68	563,8	549,98						
70	579,9	566,14						
72	596,1	582,32						
75	620,3	606,35						
76	628,4	614,65						
78	644,6	630,80						
80	660,7	646,96						
85	701,2	687,40						
90	741,6	727,81						
95	782,0	768,22						
100	822,4	808,63						
110	903,3	889,48						
114	935,6	921,81						
120	984,1	970,33						
125	1024,5	1010,73						

CORONE PER CATENE A RULLI - DIN 8188 - ISO 606 - ANSI B 29.1
PLATE WHEELS FOR ROLLER CHAINS - DIN 8188 - ISO 606 - ANSI B 29.1

ASA 100

31,75 x 19,05 mm
Rullo 19,05 mm
20A - 1

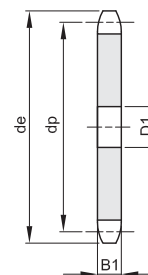
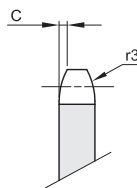

B1	B2	B3	b1	C	r3
17,6				4	33,5

Z	de	dp	semplici D1	Kg.	doppie D2	Kg.	triple D3	Kg.
8	96,0	82,96						
9	106,5	92,84						
10	117,0	102,74						
11	127,0	112,68						
12	137,0	122,68						
13	147,5	132,65						
14	157,6	142,68						
15	167,7	152,72						
16	177,7	162,75						
17	187,7	172,78	20	2,96				
18	197,8	182,85	20	3,28				
19	207,9	192,91						
20	217,9	202,98						
21	228,0	213,04	25	4,62				
22	238,1	223,11						
23	248,2	233,17						
24	258,3	243,23						
25	268,4	253,33						
26	278,4	263,40						
27	288,5	273,48						
28	298,5	283,56						
29	308,6	293,65						
30	318,7	303,75						
31	328,8	313,85						
32	338,9	323,91						
33	349,0	334,01						
34	359,1	344,10						
35	369,2	354,20						
36	379,2	364,30						
37	389,3	374,39						
38	399,4	384,49						
39	409,5	394,59						
40	419,6	404,66						
41	430,7	414,78						
42	440,8	424,88						
43	450,9	434,97						
44	461,0	445,07						
45	471,1	455,17						
46	481,2	465,26						
47	491,3	475,36						
48	501,4	485,46						
49	511,5	495,55						
50	521,6	505,65						

Z	de	dp	semplici D1	Kg.	doppie D2	Kg.	triple D3	Kg.
51	531,7	515,75						
52	541,8	525,84						
53	551,9	535,94						
54	562,0	546,07						
55	572,1	556,16						
56	582,2	566,26						
57	592,3	576,36						
58	602,4	586,45						
59	612,5	596,55						
60	622,6	606,65						
62	642,8	626,87						
64	663,0	647,06						
65	673,1	657,16						
66	683,2	667,26						
68	703,4	687,48						
70	723,6	707,67						
72	743,8	727,90						
75	774,2	758,19						
76	784,3	768,32						
80	824,7	808,72						
85	875,2	859,25						
90	925,7	909,76						
95	976,2	960,28						
100	1026,7	1010,79						
114	1168,2	1152,26						

CORONE PER CATENE A RULLI - DIN 8188 - ISO 606 - ANSI B 29.1
PLATE WHEELS FOR ROLLER CHAINS - DIN 8188 - ISO 606 - ANSI B 29.1

ASA 120

38,1 x 25,4 mm
Rullo 22,23 mm
24A - 1

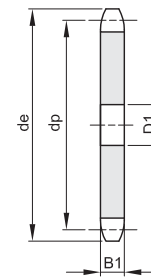
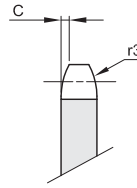

B1	B2	B3	b1	C	r3
23,5				4,8	40,5

Z	de	dp	semplici D1	Kg.	doppie D2	Kg.	triple D3	Kg.
8	113,0	99,55						
9	125,0	111,40	20	1,47				
10	137,0	123,29	20	1,85				
11	149,0	135,21	25	2,24				
12	161,0	147,22						
13	173,0	159,18	25	3,22				
14	185,0	171,22	25	3,68				
15	197,0	183,26	25	4,34				
16	209,0	195,30	25	4,88				
17	221,0	207,34	25	5,69				
18	233,0	219,42	25	6,29				
19	245,5	231,49						
20	257,5	243,57	25	7,95				
21	270,5	255,65						
22	282,5	267,73						
23	294,5	279,80						
24	307,0	291,88						
25	319,0	304,00	30	12,25				
26	331,0	316,08						
27	343,0	328,19						
28	355,0	340,27						
29	367,5	352,38						
30	379,5	364,50						
31	391,5	376,62						
32	403,5	388,69						
33	415,5	400,81						
34	428,5	412,93						
35	440,0	425,04	30	24,65				
36	452,0	437,16						
37	464,0	449,27						
38	476,5	461,39						
39	488,5	473,50						
40	501,5	485,62						
41	513,5	497,74						
42	525,5	509,85						
43	538,0	521,97						
44	550,0	534,08						
45	562,0	546,20						
46	574,0	558,32						
47	586,5	570,43						
48	598,5	582,55						
49	610,5	594,66						
50	622,5	606,78						

Z	de	dp	semplici D1	Kg.	doppie D2	Kg.	triple D3	Kg.
51	635,0	618,89						
52	647,0	631,01						
53	659,0	643,13						
54	671,0	655,25						
55	683,5	667,40						
56	695,5	679,50						
57	707,5	691,63						
58	719,5	703,74						
59	731,5	715,86						
60	745,0	727,97						
62	769,0	752,24						
64	793,5	776,48						
65	805,5	788,59						
66	817,5	800,71						
68	842,0	824,98						
70	866,0	849,21						
72	890,5	873,48						
75	926,5	909,83						
76	939,0	921,98						
80	987,5	970,44						
85	1048,0	1031,10						
90	1169,0	1152,33						

CORONE PER CATENE A RULLI - DIN 8188 - ISO 606 - ANSI B 29.1
PLATE WHEELS FOR ROLLER CHAINS - DIN 8188 - ISO 606 - ANSI B 29.1

ASA 140

44,45 x 25,4 mm
Rullo 25,4 mm
28A - 1

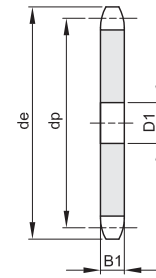
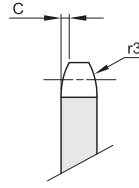

B1	B2	B3	b1	C	r3
23,5				5,8	47,5

Z	de	dp	semplici D1	Kg.	doppie D2	Kg.	triple D3	Kg.
8	132,0	116,15						
9	146,0	129,96	20	2,07				
10	160,0	143,85	20	2,59				
11	174,0	157,77	25	3,04				
12	188,0	171,74	25	3,72				
13	204,0	185,75	25	4,37				
14	218,0	199,76	25	5,16				
15	232,0	213,79						
16	246,0	227,84	30	6,85				
17	260,0	241,90	30	7,68				
18	274,0	255,98						
19	289,0	270,06						
20	303,0	284,15						
21	317,0	298,24						
22	331,0	312,34						
23	345,0	326,44						
24	359,0	340,55						
25	373,0	354,66						
26	387,0	368,77						
27	401,0	382,88						
28	416,0	397,00						
29	430,0	411,12						
30	444,0	425,24						
31	458,0	439,37						
32	472,0	453,49						
33	486,0	467,62						
34	500,0	481,75						
35	514,0	495,88						
36	529,0	510,01						
37	543,0	524,13						
38	557,0	538,27						
39	571,0	552,40						
40	585,0	566,54						
45	656,0	637,22						
50	726,0	707,91						
57	825,0	806,90						
60	869,0	849,32						
76	1095,0	1075,62						

Z	de	dp	semplici D1	Kg.	doppie D2	Kg.	triple D3	Kg.

CORONE PER CATENE TRASPORTO

PLATE WHEELS FOR CONVEYOR CHAINS

PASSO 50
RULLO 25

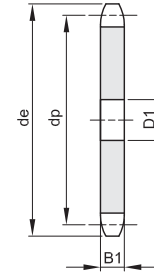
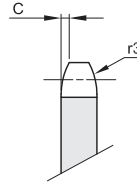

B1	C	r3
10,5	3	50

Materiale: Fe

Z	de	dp	D1	Kg.	Z	de	dp	D1	Kg.
6	121,0	100,00	20	0,55	21	356,5	335,45	30	7,39
7	136,0	115,24	20	0,76	22	372,5	351,35	30	7,88
8	151,5	130,65	20	0,92	23	388,0	367,20	30	8,15
9	167,0	146,20	20	1,15	24	404,0	383,05	30	8,68
10	183,0	161,80	25	1,52	25	420,0	398,95	30	9,66
11	198,5	177,50	25	1,86	28	467,5	446,55	30	13,15
12	214,0	193,20	25	2,20	30	499,5	478,35	30	14,82
13	230,0	208,95	25	2,56	35	579,0	557,80	30	19,10
14	245,5	224,70	25	2,99	38	626,5	605,45	30	21,50
15	261,5	240,45	25	3,40					
16	277,5	256,30	30	3,94					
17	293,0	272,11	30	4,73					
18	309,0	287,95	30	4,94					
19	325,0	303,80	30	6,00					
20	340,5	319,60	30	6,10					

PASSO 50
RULLO 31

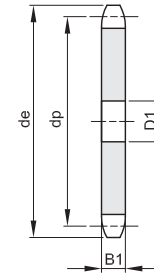
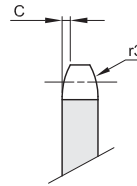

B1	C	r3
13,5	3	50

Materiale: Fe

Z	de	dp	D1	Kg.	Z	de	dp	D1	Kg.
6	120,0	100,00	20	0,61	21	355,5	335,45	30	8,65
7	135,0	115,24	20	0,86	22	371,5	351,35	30	9,44
8	150,5	130,65	20	1,16	23	387,0	367,20	30	10,28
9	166,0	146,20	20	1,48	24	403,0	383,05	30	11,25
10	182,0	161,80	25	1,83	25	419,0	398,95	30	12,30
11	197,5	177,50	25	2,27	26	435,0	414,80	30	13,34
12	213,0	193,20	25	2,72	28	466,5	446,55	30	15,52
13	229,0	208,95	25	3,21	30	498,5	478,35	30	17,95
14	244,5	224,70	25	3,71	32	530,0	510,10	30	20,46
15	260,5	240,45	25	4,33	38	625,5	605,45	30	26,60
16	276,5	256,30	30	4,94					
17	292,0	272,11	30	5,58					
18	308,0	287,95	30	6,30					
19	324,0	303,80	30	7,04					
20	339,5	319,60	30	7,82					

CORONE PER CATENE TRASPORTO

PLATE WHEELS FOR CONVEYOR CHAINS

PASSO 50,8 RULLO 30

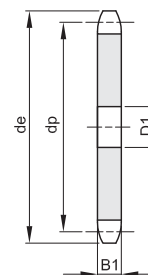
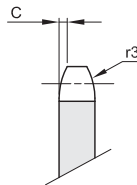

B1	C	r3
8,8	3	50

8,8	3	50
-----	---	----

Materiale: Fe

Z	de	dp	D1	Kg.
8	149,0	132,74	20	0,67
10	182,0	164,39	20	1,22
12	214,0	196,27	25	1,81
14	247,0	228,29	25	2,49
16	279,0	260,39	30	3,24

Z	de	dp	D1	Kg.

PASSO 75 RULLO 25

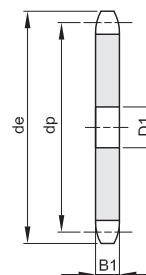
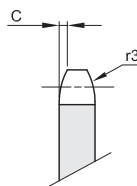

B1	C	r3
10,5	3	50

10,5	3	50
------	---	----

Materiale: Fe

Z	de	dp	D1	Kg.
8	211,0	195,98	25	2,47
10	258,0	242,70	25	3,77

Z	de	dp	D1	Kg.

PASSO 75 RULLO 31

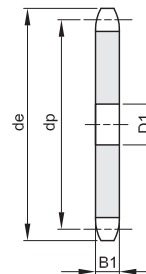
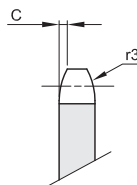

B1	C	r3
13,5	3	50

13,5	3	50
------	---	----

Materiale: Fe

Z	de	dp	D1	Kg.
6	168,0	150,00	25	1,68
8	215,0	195,98	25	2,94
9	238,0	219,30	25	3,78
10	261,0	242,70	30	4,50
11	286,0	266,25	30	5,57
12	309,0	289,80	30	6,70

Z	de	dp	D1	Kg.
13	333,0	313,42	30	7,80
14	357,0	337,05	30	9,12
15	380,0	360,73	30	10,42
16	404,0	384,45	30	11,98
20	499,0	479,40	30	18,35
21	523,0	503,17	30	20,62

CORONE PER CATENE TRASPORTO PLATE WHEELS FOR CONVEYOR CHAINS

**PASSO 100
RULLO 31**

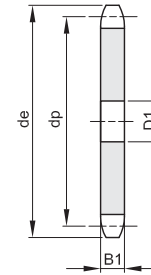
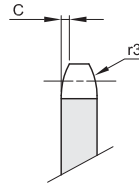

B1	C	r3
13,5	3	50

Materiale: Fe

Z	de	dp	D1	Kg.
6	218,0	200,00	25	3,32
7	249,0	230,48	25	4,32
8	280,0	261,31	30	5,50
9	311,0	292,40	30	6,95
10	342,0	323,61	30	8,57
11	375,0	354,95	30	10,29
12	406,0	386,40	30	12,45
13	437,0	417,90	30	14,45
14	469,0	449,40	30	16,84
15	500,0	480,97	30	19,36
16	532,0	512,60	30	21,76

Z	de	dp	D1	Kg.

**PASSO 100
RULLO 40**

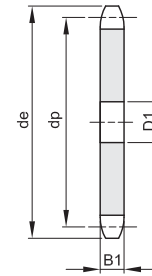
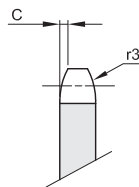

B1	C	r3
20	3	50

Materiale: Fe

Z	de	dp	D1	Kg.
6	220,0	200,00	25	4,54
7	251,0	230,48	25	6,10
8	283,0	261,31	30	7,87
9	314,0	292,40	30	9,94
10	345,0	323,61	30	12,25
11	378,0	354,95	30	14,72
12	409,0	386,40	30	17,48
13	441,0	417,90	30	20,90

Z	de	dp	D1	Kg.

PIGNONI PER CATENE TRASPORTO SPROCKETS FOR CONVEYOR CHAINS

**PASSO 50
RULLO 25**

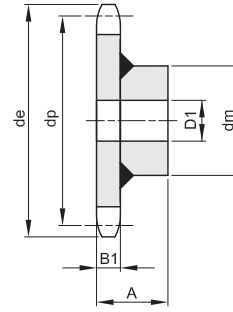
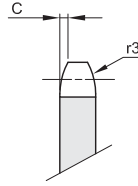

B1	C	r3
10,5	3	50

Materiale: Fe

Z	de	dp	dm	D1	A	Kg.
6	121,0	100,00	58	20	40,5	1,11
7	136,0	115,24	58	20	40,5	1,37
8	151,5	130,65	58	20	40,5	1,55
9	167,0	146,20	58	20	40,5	1,89
10	183,0	161,80	88	25	45,5	3,10
11	198,5	177,50	88	25	45,5	3,44
12	214,0	193,20	88	25	45,5	3,79
13	230,0	208,95	88	25	45,5	4,17
14	245,5	224,70	88	25	45,5	4,63
15	261,5	240,45	88	25	45,5	5,09
16	277,5	256,30	118	30	60,5	8,26
17	293,0	272,11	118	30	60,5	9,10
18	309,0	287,95	118	30	60,5	9,26
19	325,0	303,80	118	30	60,5	10,32
20	340,5	319,60	118	30	60,5	10,42

Z	de	dp	dm	D1	A	Kg.
21	356,5	335,45	118	30	60,5	11,71
22	372,5	351,35	118	30	60,5	12,20
23	388,0	367,20	118	30	60,5	12,47
24	404,0	383,05	118	30	60,5	13,00
25	420,0	398,95	118	30	60,5	13,98
28	467,5	446,55	133	30	62	18,62
30	499,5	478,35	133	30	62	20,29
35	579,0	557,80	133	30	62	24,57
38	626,5	605,45	133	30	62	26,97

**PASSO 50
RULLO 31**

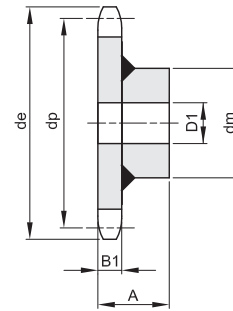
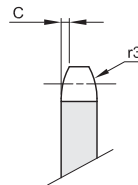

B1	C	r3
13,5	3	50

Materiale: Fe

Z	de	dp	dm	D1	A	Kg.
6	120,0	100,00	58	20	43,5	1,18
7	135,0	115,24	58	20	43,5	1,44
8	150,5	130,65	58	20	43,5	1,72
9	166,0	146,20	58	20	43,5	2,05
10	182,0	161,80	88	25	48,5	3,40
11	197,5	177,50	88	25	48,5	3,80
12	213,0	193,20	88	25	48,5	4,30
13	229,0	208,95	88	25	48,5	4,78
14	244,5	224,70	88	25	48,5	5,37
15	260,5	240,45	88	25	48,5	5,98
16	276,5	256,30	118	30	63,5	9,05
17	292,0	272,11	118	30	63,5	9,60
18	308,0	287,95	118	30	63,5	10,30
19	324,0	303,80	118	30	63,5	11,10
20	339,5	319,60	118	30	63,5	11,90

Z	de	dp	dm	D1	A	Kg.
21	355,5	335,45	118	30	63,5	12,75
22	371,5	351,35	118	30	63,5	13,54
23	387,0	367,20	118	30	63,5	14,38
24	403,0	383,05	118	30	63,5	15,35
25	419,0	398,95	118	30	63,5	16,40
26	435,0	414,80	133	30	65	18,81
28	466,5	446,55	133	30	65	21,00
30	498,5	478,35	133	30	65	23,42
32	530,0	510,10	133	30	65	25,93
38	625,5	605,45	133	30	65	32,10

PIGNONI PER CATENE TRASPORTO SPROCKETS FOR CONVEYOR CHAINS

**PASSO 50,8
RULLO 30**

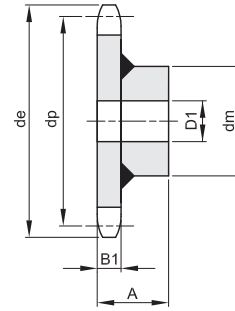
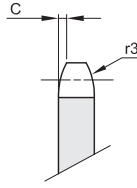

B1	C	r3
8,8	3	50

Materiale: Fe

Z	de	dp	dm	D1	A	Kg.
8	149,0	132,74	58	20	39	1,35
10	182,0	164,39	88	20	44	2,85
12	214,0	196,27	88	25	44	3,37
14	247,0	228,29	88	25	44	4,08
16	279,0	260,39	118	30	59	7,34

Z	de	dp	dm	D1	A	Kg.

**PASSO 75
RULLO 25**

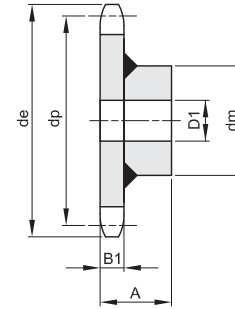
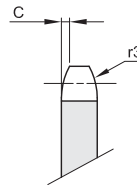

B1	C	r3
10,5	3	50

Materiale: Fe

Z	de	dp	dm	D1	A	Kg.
8	211,0	195,98	88	25	45,5	4,07
10	258,0	242,70	118	25	60,5	7,87

Z	de	dp	dm	D1	A	Kg.

**PASSO 75
RULLO 31**

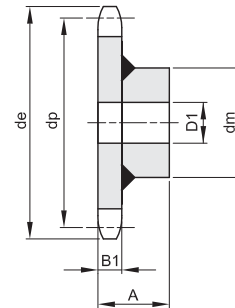
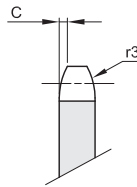

B1	C	r3
13,5	3	50

Materiale: Fe

Z	de	dp	dm	D1	A	Kg.
6	168,0	150,00	88	25	48,5	3,26
8	215,0	195,98	88	25	48,5	4,52
9	238,0	219,30	88	25	48,5	5,36
10	261,0	242,70	118	30	63,5	8,70
11	286,0	266,25	118	30	63,5	9,60
12	309,0	289,80	118	30	63,5	10,73

Z	de	dp	dm	D1	A	Kg.
13	333,0	313,42	118	30	63,5	11,83
14	357,0	337,05	118	30	63,5	13,15
15	380,0	360,73	118	30	63,5	14,45
16	404,0	384,45	133	30	65	17,43
20	499,0	479,40	133	30	65	23,80
21	523,0	503,17	133	30	65	26,07

PIGNONI PER CATENE TRASPORTO SPROCKETS FOR CONVEYOR CHAINS

**PASSO 100
RULLO 31**

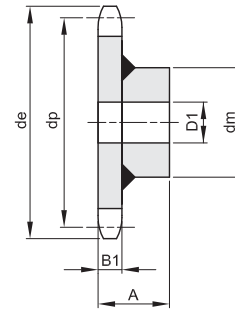
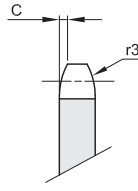

B1	C	r3
13,5	3	50

Materiale: Fe

Z	de	dp	dm	D1	A	Kg.
6	218,0	200,00	88	25	48,5	4,80
7	249,0	230,48	88	25	48,5	5,80
8	280,0	261,31	118	30	63,5	9,67
9	311,0	292,40	118	30	63,5	10,95
10	342,0	323,61	118	30	63,5	12,63
11	375,0	354,95	118	30	63,5	14,34
12	406,0	386,40	118	30	63,5	16,51
13	437,0	417,90	118	30	63,5	18,51
14	469,0	449,40	118	30	63,5	20,93
15	500,0	480,97	118	30	63,5	23,42
16	532,0	512,60	133	30	65,0	27,16

Z	de	dp	dm	D1	A	Kg.

**PASSO 100
RULLO 40**

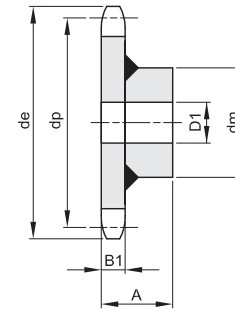
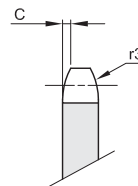

B1	C	r3
20	3	50

Materiale: Fe

Z	de	dp	dm	D1	A	Kg.
6	220,0	200,00	118	25	70	8,64
7	251,0	230,48	118	25	70	10,20
8	283,0	261,31	118	30	70	11,97
9	314,0	292,40	118	30	70	14,04
10	345,0	323,61	118	30	70	16,35
11	378,0	354,95	118	30	70	18,82
12	409,0	386,40	118	30	70	21,58
13	441,0	417,90	118	30	70	25,00

Z	de	dp	dm	D1	A	Kg.

SCELTA DEL PASSO DELLE CATENE A RULLI - DIN 8187 - ISO 606

CHOICE OF ROLLER CHAINS PITCH - DIN 8187 - ISO 606

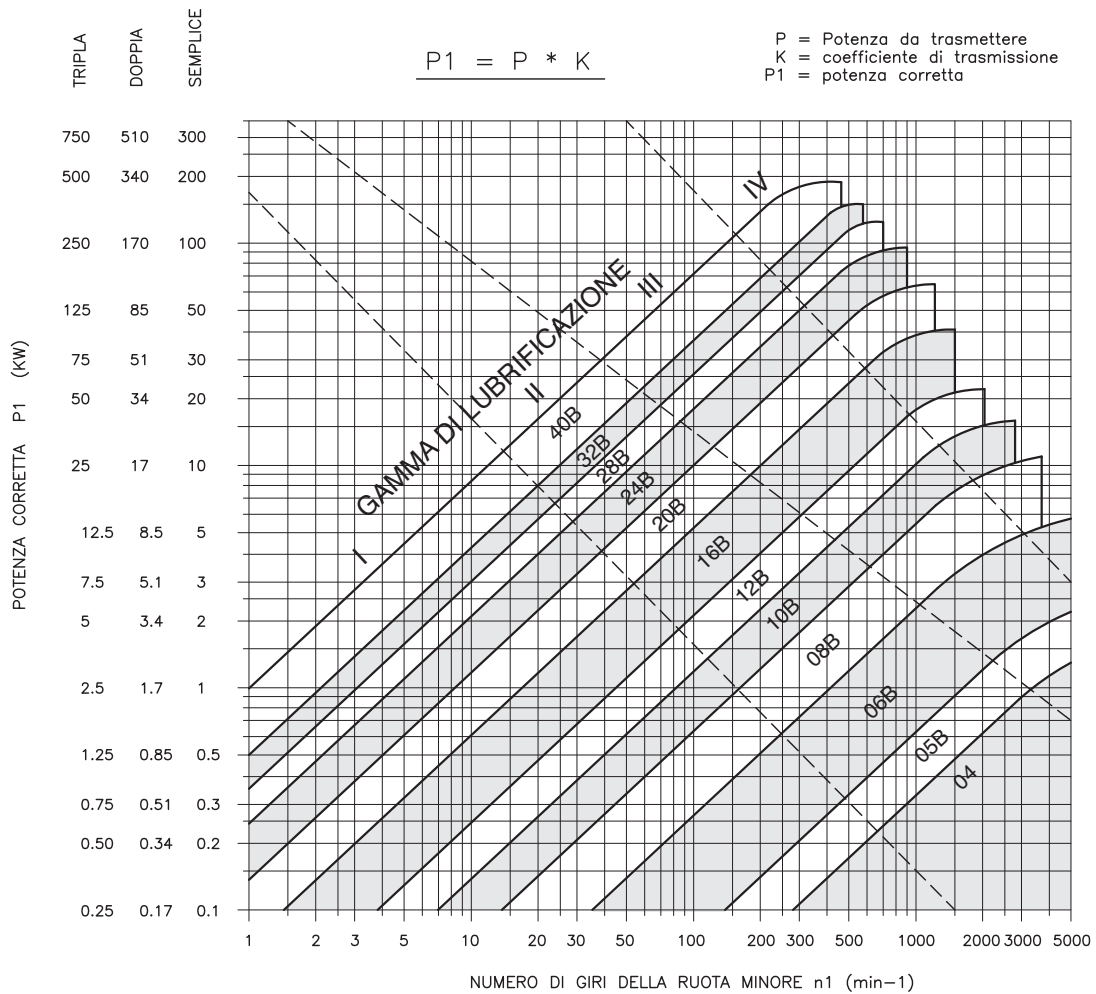

COEFFICIENTE DI TRASMISSIONE "K" PER MOTORI A SCOPPIO AUMENTARE IL FATTORE "K" DI 0,5

modalità d'avanzamento	rapporto di trasmissione $i = n1/n2 = z2/z1$	numero denti della ruota minore z1							
		11	13	15	17	19	21	23	25
Avanzamento senza urti Sollecitazione regolare	1:1	*2,22	*1,85	1,59	1,39	1,22	1,10	0,99	0,91
	2:1	*1,97	1,64	1,41	1,23	1,08	0,97	0,88	0,80
	3:1	1,82	1,52	1,30	1,14	1,00	0,90	0,81	0,74
	5:1	1,68	1,40	1,20	1,05	0,92	0,83	0,75	0,68
Marcia regolare con urti leggeri occasionali, sollecitazione leggermente ondulata	1:1	*2,78	*2,32	1,98	1,74	1,53	1,38	1,24	1,13
	2:1	*2,46	*2,05	1,76	1,55	1,35	1,22	1,10	1,05
	3:1	*2,28	1,90	1,63	1,43	1,25	1,13	1,02	0,93
	5:1	2,10	1,75	1,50	1,31	1,15	1,04	0,93	0,85
Urti leggeri, sollecitazione mediamente ondulata	1:1	*3,33	*2,79	2,38	2,09	1,83	1,65	1,49	1,36
	2:1	*2,95	*2,47	2,11	1,85	1,62	1,46	1,31	1,20
	3:1	*2,73	2,28	1,95	1,71	1,50	1,35	1,22	1,11
	5:1	*2,52	2,10	1,80	1,58	1,38	1,25	1,12	1,03
Urti medi, sollecitazione fortemente ondulata	1:1	*3,89	*3,25	*2,78	2,44	2,14	1,92	1,73	1,58
	2:1	*3,44	*2,87	2,46	2,16	1,89	1,70	1,53	1,40
	3:1	*3,19	*2,66	2,28	2,00	1,75	1,58	1,42	1,30
	5:1	*2,93	*2,45	2,09	1,84	1,16	1,45	1,31	1,19
Urti forti, sollecitazione alternata	1:1	*4,44	*3,71	*3,17	*2,78	2,44	2,20	1,98	1,81
	2:1	*3,93	*3,28	*2,81	2,46	2,16	1,95	1,75	1,60
	3:1	*3,64	*3,04	2,60	2,28	2,00	1,80	1,62	1,48
	5:1	*3,35	*2,80	2,39	2,10	1,84	1,66	1,49	1,36

* condizioni d'avanzamento da evitare

SCelta DEL PASSO DELLE CATENE A RULLI - DIN 8188 - ANSI B29.1 "ASA" CHOICE OF ROLLER CHAINS PITCH - DIN 8188 - ANSI B29.1 "ASA"



TAVOLA SINOTTICA DEI LUBRIFICANTI

gamma di lubrificazione	velocità della catena m/s	lubrificazione consigliata	potenza trasmissibile			
			lubrificazione corretta	lubrificazione insufficiente senza detriti	lubrificazione insufficiente presenza di detriti	senza lubrificazione
I	fino a ~ 1,5	lubrificazione manuale con pennello - lubrificazione col contagocce (da 4 a 14 gocce al 1')	100%	60%	30%	15%
II	fino a ~ 7	lubrificazione in bagno d'olio all'interno del carter ove è installata la catena lubrificazione col contagocce (~20 gocce d'olio al 1')	100%	30%	15%	—
III	fino a ~ 12	lubrificazione a circolazione forzata tramite disco dosatore installato all'interno del carter - lubrificazione in bagno d'olio	100%	non ammissibile	—	—
IV	oltre 12	lubrificazione a spruzzo mediante pompa di circolazione dell'olio - lubrificazione a circolazione forzata - prevede il raffreddamento	100%	non ammissibile	—	—

CATENE A RULLI SERIE EUROPEA - DIN 8187 - ISO 606

ROLLER CHAINS EUROPEAN STANDARD - DIN 8187 - ISO 606

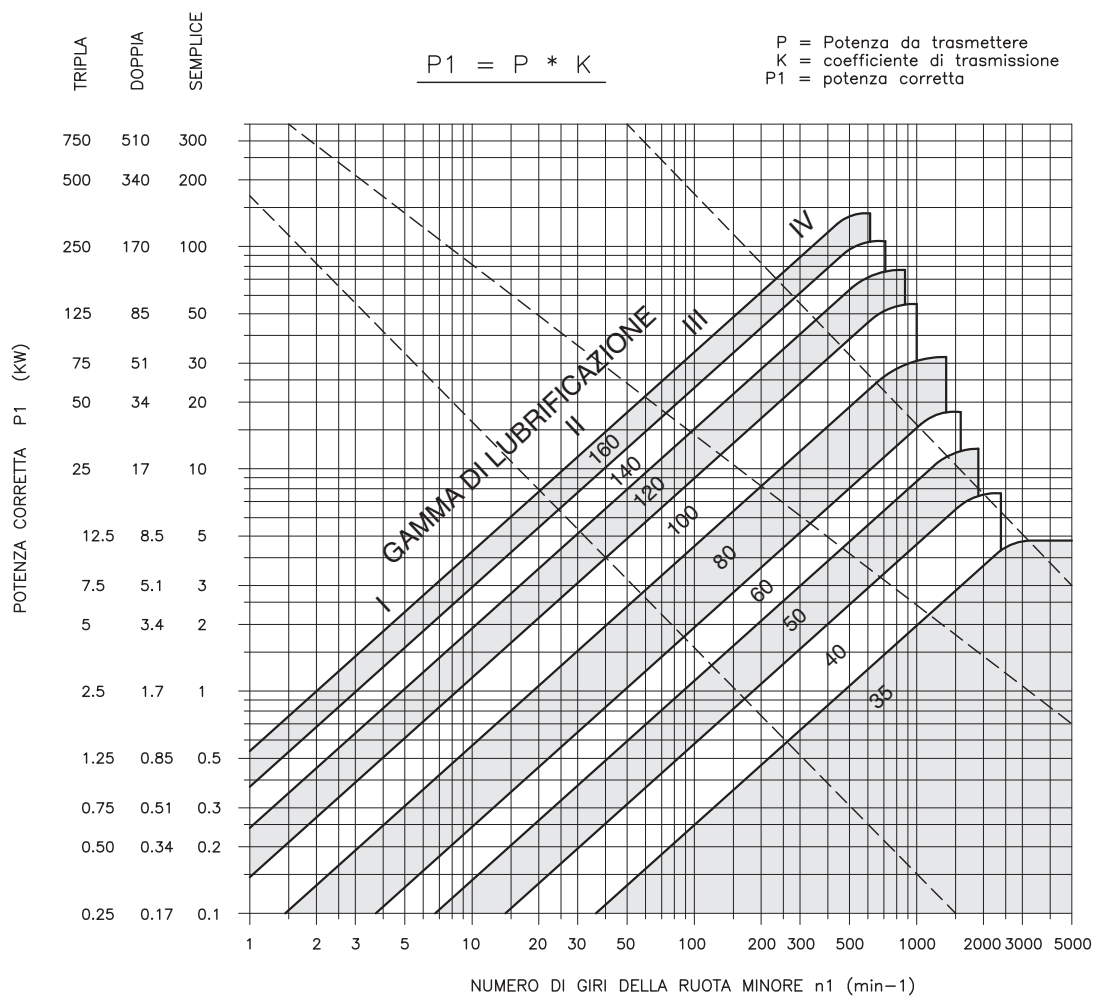
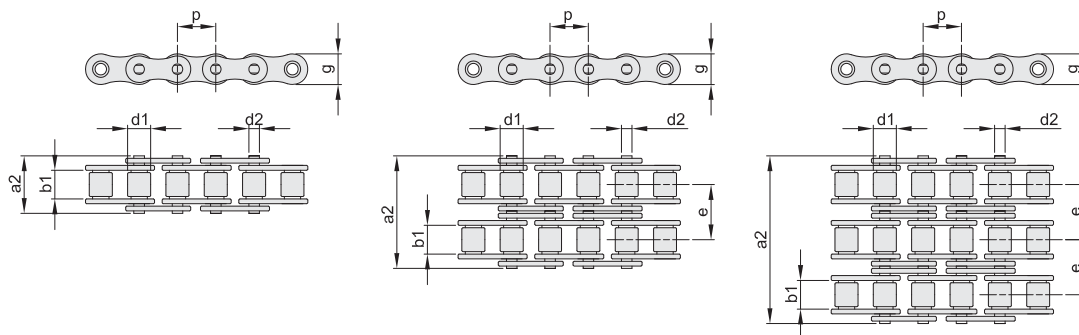

CATENA PRODOTTA DA AZIENDA CERTIFICATA ISO 9001 - ISO 14001 E API 7F
CHAIN PRODUCED BY ISO 9001 - ISO 14001 AND API 7F CERTIFIED COMPANY

CATENA PRESTIRATA / PRE-STRETCHED CHAINS



SEMPLICE

ISO	p		b ₁ mm min.	d ₂ mm	d ₁ mm max.	a ₂ mm max.	g mm max.	Carico di rottura		q kg/m ≈
	mm	inch						minimo KN	medio KN	
04-1	6	-	2,80	1,85	4,00	7,4	5,00	3,0	3,3	0,12
05B-1 ▲	8	-	3,00	2,31	5,00	8,6	7,11	5,0	5,9	0,18
06B-1 ▲	9,525	3/8"	5,72	3,28	6,35	13,5	8,26	9,0	10,7	0,40
084-1	12,7	1/2"	4,88	4,09	7,75	14,8	11,15	15,7	17,5	0,49
08B-1 ▲	12,7	1/2"	7,75	4,45	8,51	17,0	11,81	18,0	21,1	0,68
10B-1 ▲	15,875	5/8"	9,65	5,08	10,16	19,6	14,73	22,4	27,4	0,91
12B-1 ▲	19,05	3/4"	11,68	5,72	12,07	22,7	16,13	29,0	32,3	1,12
16B-1	25,4	1"	17,02	8,28	15,88	36,1	21,08	60,0	70,6	2,59
20B-1	31,75	1 1/4"	19,56	10,19	19,05	43,2	26,42	95,0	109,8	3,68
24B-1	38,1	1 1/2"	25,40	14,63	25,40	53,4	33,40	160,0	179,0	6,85
28B-1	44,45	1 3/4"	30,99	15,90	27,94	65,1	37,08	200,0	226,0	8,56
32B-1	50,8	2"	30,99	17,81	29,21	67,4	42,29	250,0	273,0	9,49
40B-1	63,5	2 1/2"	38,10	22,89	39,37	82,6	52,90	355,0	390,0	15,53

▲ Fornita anche in rotoli/Supplied also in reels.

DOPPIA

ISO	p		b ₁ mm min.	d ₂ mm	d ₁ mm max.	a ₂ mm max.	g mm max.	e mm	Carico di rottura		q kg/m ≈
	mm	inch							minimo KN	medio KN	
05B-2	8	-	3,00	2,31	5,00	14,3	7,11	5,64	7,8	8,5	0,32
06B-2	9,525	3/8"	5,72	3,28	6,35	23,8	8,26	10,24	16,9	19,2	0,76
08B-2	12,7	1/2"	7,75	4,45	8,51	31,0	11,81	13,92	32,0	38,0	1,31
10B-2	15,875	5/8"	9,65	5,08	10,16	36,2	14,73	16,59	44,5	57,3	1,79
12B-2	19,05	3/4"	11,68	5,72	12,07	42,2	16,13	19,46	57,8	65,7	2,22
16B-2	25,4	1"	17,02	8,28	15,88	68,0	21,08	31,88	113,7	137,5	5,03
20B-2	31,75	1 1/4"	19,56	10,19	19,05	79,7	26,42	36,45	170,0	210,0	7,33
24B-2	38,1	1 1/2"	25,40	14,63	25,40	101,8	33,40	48,36	280,0	322,5	13,50
28B-2	44,45	1 3/4"	30,99	15,90	27,94	124,7	37,08	59,56	360,0	412,6	16,96
32B-2	50,8	2"	30,99	17,81	29,21	126,0	42,99	58,55	450,0	510,8	18,74
40B-2	63,5	2 1/2"	38,10	22,89	39,37	154,0	52,90	72,29	630,0	708,1	30,72

TRIPLA

ISO	p		b ₁ mm min.	d ₂ mm	d ₁ mm max.	a ₂ mm max.	g mm max.	e mm	Carico di rottura		q kg/m ≈
	mm	inch							minimo KN	medio KN	
06B-3	9,525	3/8"	5,72	3,28	6,35	34,0	8,26	10,24	24,9	27,7	1,12
08B-3	12,7	1/2"	7,75	4,45	8,51	44,9	11,81	13,92	47,5	56,0	1,94
10B-3	15,875	5/8"	9,65	5,08	10,16	52,8	14,73	16,59	66,7	83,3	2,68
12B-3	19,05	3/4"	11,68	5,72	12,07	61,7	16,13	19,46	86,7	101,5	3,32
16B-3	25,4	1"	17,02	8,28	15,88	99,9	21,08	31,88	160,0	202,8	7,65
20B-3	31,75	1 1/4"	19,56	10,19	19,05	116,1	26,42	36,45	250,0	306,5	10,96
24B-3	38,1	1 1/2"	25,40	14,63	25,40	150,2	33,40	48,36	425,0	490,6	20,20
28B-3	44,45	1 3/4"	30,99	15,90	27,94	184,3	37,08	59,56	530,0	625,9	25,38
32B-3	50,8	2"	30,99	17,81	29,21	184,5	42,99	58,55	670,0	775,0	28,04

CATENE A RULLI SERIE AMERICANA - DIN 8188 - ANSI B29.1 "ASA" ROLLER CHAINS AMERICAN STANDARD - DIN 8188 - ANSI B29.1 "ASA"

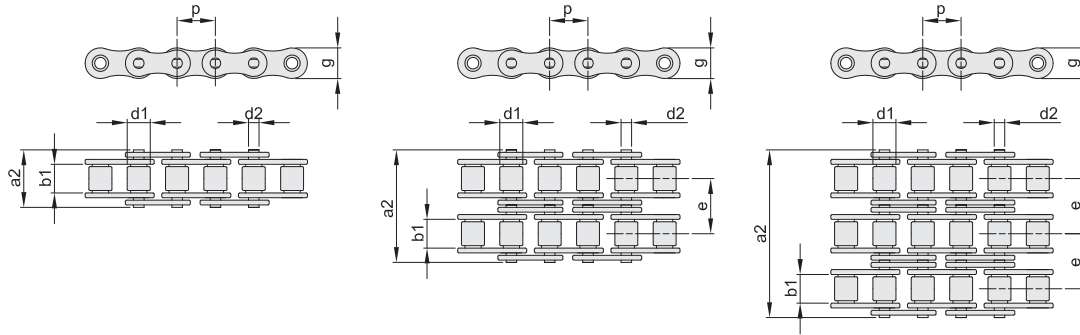

CATENA PRODOTTA DA AZIENDA CERTIFICATA ISO 9001 - ISO 14001 E API 7F
CHAIN PRODUCED BY ISO 9001 - ISO 14001 AND API 7F CERTIFIED COMPANY

CATENA PRESTIRATA / PRE-STRETCHED CHAINS



SEMPLICE

ANSI	p		b ₁ mm min.	d ₂ mm	d ₁ mm max.	a ₂ mm max.	g mm max.	Carico di rottura		q kg/m ≈
	mm	inch						minimo KN	medio KN	
35-1	9,525	3/8"	4,77	3,58	5,08	13,2	9,05	7,8	10,1	0,34
40-1	12,7	1/2"	7,95	3,96	7,92	17,8	12,07	14,1	18,8	0,63
50-1	15,875	5/8"	9,53	5,08	10,16	21,8	15,09	22,2	30,4	1,04
60-1	19,05	3/4"	12,70	5,94	11,91	26,9	18,08	31,8	41,7	1,52
80-1	25,4	1"	15,88	7,92	15,88	33,5	24,13	56,7	72,6	2,58
100-1	31,75	1 1/4"	19,05	9,53	19,05	41,1	30,18	88,5	110,4	3,85
120-1	38,1	1 1/2"	25,40	11,10	22,23	50,8	36,20	127,0	144,6	5,61
140-1	44,45	1 3/4"	25,40	12,70	25,40	54,9	42,24	172,4	190,8	7,24
160-1	50,8	2"	31,75	14,27	28,58	65,5	48,26	226,8	253,4	9,91
60-1H	19,05	3/4"	12,70	5,94	11,91	31,2	18,08	31,2	42,1	1,81
80-1H	25,4	1"	15,88	7,92	15,88	38,0	24,13	55,6	72,6	3,00
100-1H	31,75	1 1/4"	19,05	9,53	19,05	45,4	30,18	86,8	110,4	4,38

DOPPIA

ANSI	p		b ₁ mm min.	d ₂ mm	d ₁ mm max.	a ₂ mm max.	g mm max.	e mm	Carico di rottura		q kg/m ≈
	mm	inch							minimo KN	medio KN	
35-2	9,525	3/8"	4,77	3,58	5,08	21,6	9,05	10,13	15,6	20,3	0,67
40-2	12,7	1/2"	7,95	3,96	7,92	32,3	12,07	14,38	28,2	37,7	1,26
50-2	15,875	5/8"	9,53	5,08	10,16	39,9	15,09	18,11	44,4	60,8	2,05
60-2	19,05	3/4"	12,70	5,94	11,91	49,8	18,08	22,78	63,3	83,4	3,01
80-2	25,4	1"	15,88	7,92	15,88	62,7	24,13	29,29	113,4	145,1	5,13
100-2	31,75	1 1/4"	19,05	9,53	19,05	77,0	30,18	35,76	177,0	220,8	7,64
120-2	38,1	1 1/2"	25,40	11,10	22,23	96,3	36,20	45,44	254,0	289,3	11,13
140-2	44,45	1 3/4"	25,40	12,70	25,40	103,6	42,24	48,87	344,8	381,6	14,37
160-2	50,8	2"	31,75	14,27	28,58	124,2	48,26	58,55	453,6	506,7	19,68

TRIPLA

ANSI	p		b ₁ mm min.	d ₂ mm	d ₁ mm max.	a ₂ mm max.	g mm max.	e mm	Carico di rottura		q kg/m ≈
	mm	inch							minimo KN	medio KN	
35-3	9,525	3/8"	4,77	3,58	5,08	31,8	9,05	10,13	23,4	30,5	0,99
40-3	12,7	1/2"	7,95	3,96	7,92	46,7	12,07	14,38	42,3	56,6	1,98
50-3	15,875	5/8"	9,53	5,08	10,16	57,9	15,09	18,11	66,6	82,5	3,06
60-3	19,05	3/4"	12,70	5,94	11,91	72,6	18,08	22,78	95,4	120,1	4,50
80-3	25,4	1"	15,88	7,92	15,88	91,7	24,13	29,29	170,1	201,9	7,67
100-3	31,75	1 1/4"	19,05	9,53	19,05	113,0	30,18	35,76	265,5	313,9	11,43
120-3	38,1	1 1/2"	25,40	11,10	22,23	141,7	36,20	45,44	381,0	433,9	16,67
140-3	44,45	1 3/4"	25,40	12,70	25,40	152,4	42,24	48,87	517,2	583,4	21,51
160-3	50,8	2"	31,75	14,27	28,58	182,9	48,26	58,55	680,4	760,1	29,45

CATENE A RULLI CON PIASTRE A PROFILO DIRITTO - DIN 8187 - ISO 606

ROLLER CHAINS WITH STRAIGHT PLATES - DIN 8187 - ISO 606

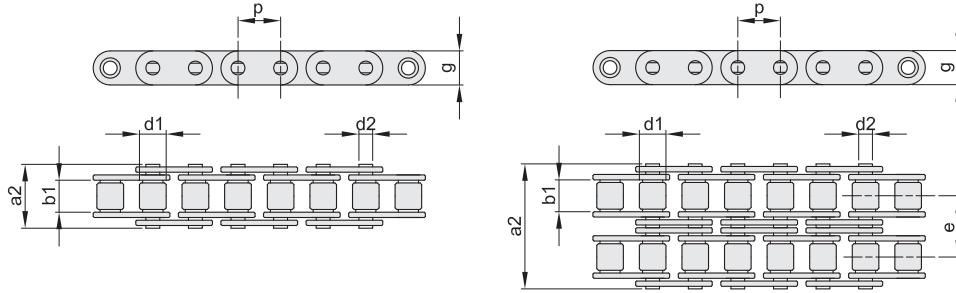

CATENA PRODOTTA DA AZIENDA CERTIFICATA ISO 9001 - ISO 14001 E API 7F
CHAIN PRODUCED BY ISO 9001 - ISO 14001 AND API 7F CERTIFIED COMPANY



CATENA PRESTIRATA / PRE-STRETCHED CHAINS

SEMPLICE

ISO	p		b ₁ mm min.	d ₂ mm	d ₁ mm max.	a ₂ mm max.	g mm max.	Carico di rottura		q kg/m ≈
	mm	inch						minimo KN	medio KN	
08B-1	12,7	1/2"	7,75	4,45	8,51	17,0	11,8	18,0	21,1	0,75
10B-1	15,875	5/8"	9,65	5,08	10,16	19,6	14,7	22,4	27,4	0,98
12B-1	19,05	3/4"	11,68	5,72	12,07	22,7	16,1	29,0	32,3	1,24
16B-1	25,4	1"	17,02	8,28	15,88	36,1	20,6	60,0	70,6	3,30
20B-1	31,75	1" 1/4	19,56	10,19	19,05	43,2	26,4	95,0	109,8	3,91

DOPPIA

ISO	p		b ₁ mm min.	d ₂ mm	d ₁ mm max.	a ₂ mm max.	g mm max.	e mm	Carico di rottura		q kg/m ≈
	mm	inch							minimo KN	medio KN	
10B-2	15,875	5/8"	9,65	5,08	10,16	36,2	14,7	16,59	44,5	57,3	1,97
12B-2	19,05	3/4"	11,68	5,72	12,07	42,2	16,1	19,46	57,8	65,7	2,27
16B-2	25,4	1"	17,02	8,28	15,88	68,0	20,6	31,88	113,7	137,5	5,78
20B-2	31,75	1" 1/4	19,56	10,19	19,05	79,7	26,4	35,45	170,0	210,0	7,72

CATENE A PERNI FORATI - DIN 8187 - ISO 606

HOLLOW PINS CHAINS - DIN 8187 - ISO 606

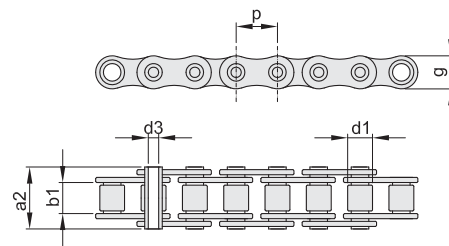
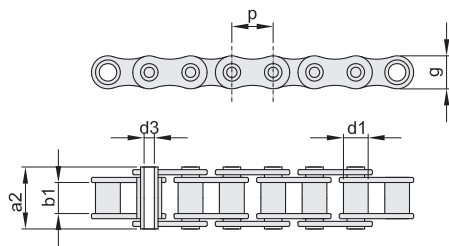

TIPO A - A BUSSOLA

TIPO B - A RULLI

CATENA PRODOTTA DA AZIENDA CERTIFICATA ISO 9001 - ISO 14001 E API 7F
CHAIN PRODUCED BY ISO 9001 - ISO 14001 AND API 7F CERTIFIED COMPANY



CATENA PRESTIRATA / PRE-STRETCHED CHAINS

ISO	p		b ₁ mm min.	d ₂ mm	d ₁ mm max.	a ₂ mm max.	g mm max.	Carico di rottura		q kg/m ≈	TIPO
	mm	inch						minimo KN	medio KN		
08B-1	12,7	1/2"	7,75	4,50	8,51	17,0	11,6	9,3	12,8	0,58	A
10B-1	15,875	5/8"	9,65	5,18	10,16	19,6	14,7	12,7	16,4	0,73	A
10A-1	15,875	5/8"	9,53	5,18	10,16	20,5	14,7	18,1	19,9	0,85	A
12B-1	19,05	3/4"	11,68	5,85	12,07	22,7	15,9	12,7	17,5	1,10	A
08B-1	12,7	1/2"	7,75	4,50	8,51	17,0	11,6	10,8	17,4	0,58	B
10B-1	15,875	5/8"	9,65	5,18	10,16	19,6	14,5	14,7	19,7	0,77	B
12B-1	19,05	3/4"	11,68	5,85	12,07	22,7	15,9	16,7	23,3	0,98	B
16B-1	25,4	1"	17,02	8,33	15,88	36,1	20,5	32,7	41,0	2,21	B

CATENE A RULLI AUTOLUBRIFICANTI - DIN 8187 - ISO 606

SINTERED BUSH CHAINS - DIN 8187 - ISO 606

Costruita con speciali bussole in acciaio sinterizzato. Indicata per applicazioni con scarsa lubrificazione come nelle industrie alimentari, chimiche, farmaceutiche, elettroniche ecc.

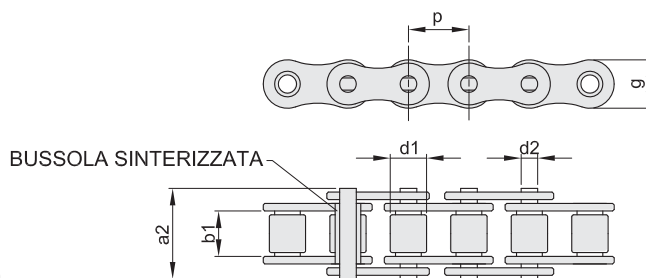
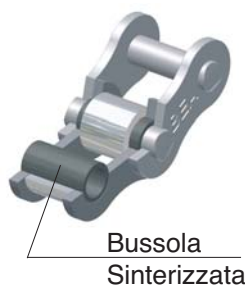

CATENA PRODOTTA DA AZIENDA CERTIFICATA ISO 9001 - ISO 14001 E API 7F
CHAIN PRODUCED BY ISO 9001 - ISO 14001 AND API 7F CERTIFIED COMPANY



CATENA PRESTIRATA / PRE-STRETCHED CHAINS

ISO	p		b ₁ mm min.	d ₂ mm	d ₁ mm max.	a ₂ mm max.	g mm max.	Carico di rottura		q kg/m ≈
	mm	inch						minimo KN	medio KN	
08B-1	12,7	1/2"	7,75	4,45	8,51	17,0	12,40	18,0	19,6	0,70
10B-1	15,875	5/8"	9,65	5,08	10,16	19,6	14,70	22,4	25,7	0,88
12B-1	19,05	3/4"	11,68	5,72	12,07	22,7	16,10	29,0	30,4	1,10

CATENE A RULLI "O-RING" - DIN 8187 - ISO 606

"O-RING" CHAINS - DIN 8187 - ISO 606

Costruita con anelli di tenuta lubrificati che impediscono l'entrata di detriti e offrono una maggiore resistenza all'usura.

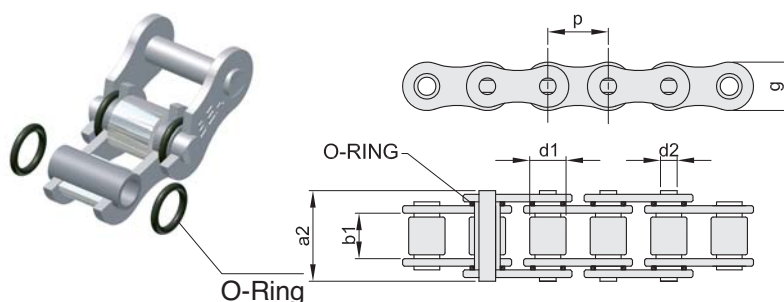

CATENA PRODOTTA DA AZIENDA CERTIFICATA ISO 9001 - ISO 14001 E API 7F
CHAIN PRODUCED BY ISO 9001 - ISO 14001 AND API 7F CERTIFIED COMPANY



CATENA PRESTIRATA / PRE-STRETCHED CHAINS

ISO	p		b ₁ mm min.	d ₂ mm	d ₁ mm max.	a ₂ mm max.	g mm max.	Carico di rottura		q kg/m ≈
	mm	inch						minimo KN	medio KN	
08B-1	12,7	1/2"	7,75	4,45	8,51	19,0	11,56	18,1	18,4	0,70
10B-1	15,875	5/8"	9,65	5,06	10,16	21,9	14,48	22,2	23,8	0,92

CATENE A RULLI CON ATTACCHI ANGOLARI - DIN 8187 - ISO 606

ROLLER CHAINS WITH ANGLE ATTACHMENTS - DIN 8187 - ISO 606

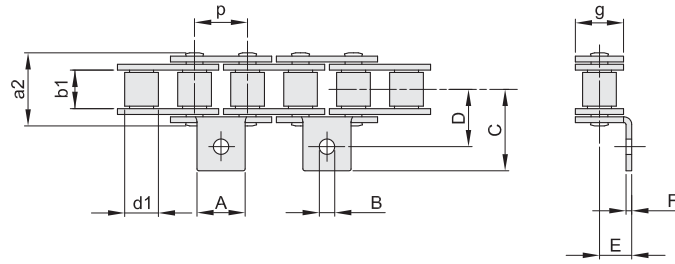

A1/02

CATENA PRODOTTA DA AZIENDA CERTIFICATA ISO 9001 - ISO 14001 E API 7F
CHAIN PRODUCED BY ISO 9001 - ISO 14001 AND API 7F CERTIFIED COMPANY



CATENA PRESTIRATA / PRE-STRETCHED CHAINS

ISO	p		b ₁ mm min.	d ₁ mm max.	a ₂ mm max.	g mm max.	A mm	B mm	C mm max.	D mm	E mm	F mm	Carico di rottura		q kg/m ≈
	mm	inch											minimo KN	medio KN	
06B-1	9,525	3/8"	5,72	6,35	13,5	8,26	8,0	3,5	13,5	9,5	6,5	1,03	9,0	10,7	0,46
08B-1	12,7	1/2"	7,75	8,51	17,0	11,81	9,5	4,3	18,6	14,1	8,4	1,40	18,0	21,1	0,77
10B-1	15,875	5/8"	9,65	10,16	19,6	14,73	14,1	5,2	23,8	15,9	10,4	1,63	22,4	27,4	1,04
12B-1	19,05	3/4"	11,68	12,07	22,7	16,13	15,8	5,6	25,8	17,5	12,0	1,80	29,0	32,3	1,35
16B-1	25,4	1"	17,02	15,88	36,1	21,08	19,0	6,8	37,4	25,4	15,9	3,00	60,0	70,6	3,09

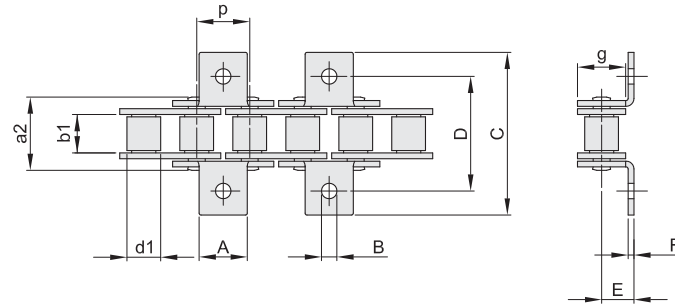

K1/02

CATENA PRODOTTA DA AZIENDA CERTIFICATA ISO 9001 - ISO 14001 E API 7F
CHAIN PRODUCED BY ISO 9001 - ISO 14001 AND API 7F CERTIFIED COMPANY



CATENA PRESTIRATA / PRE-STRETCHED CHAINS

ISO	p		b ₁ mm min.	d ₁ mm max.	a ₂ mm max.	g mm max.	A mm	B mm	C mm max.	D mm	E mm	F mm	Carico di rottura		q kg/m ≈
	mm	inch											minimo KN	medio KN	
06B-1	9,525	3/8"	5,72	6,35	13,5	8,26	8,0	3,5	27,0	19,0	6,5	1,03	9,0	10,7	0,51
08B-1	12,7	1/2"	7,75	8,51	17,0	11,81	9,5	4,3	37,2	28,2	8,4	1,40	18,0	21,1	0,85
10B-1	15,875	5/8"	9,65	10,16	19,6	14,73	14,1	5,2	47,6	31,8	10,4	1,63	22,4	27,4	1,13
12B-1	19,05	3/4"	11,68	12,07	22,7	16,13	15,8	5,6	51,6	35,0	12,0	1,80	29,0	32,3	1,45
16B-1	25,4	1"	17,02	15,88	36,1	21,08	19,0	6,8	74,8	50,8	15,9	3,00	60,0	70,6	3,48

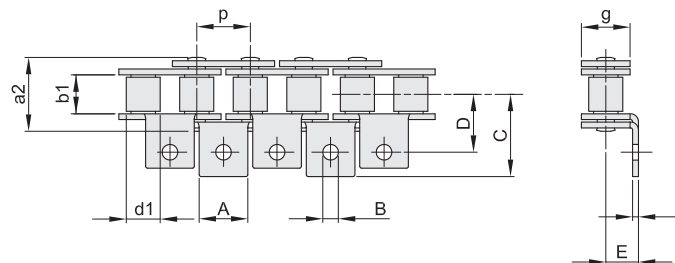

A1/01

CATENA PRODOTTA DA AZIENDA CERTIFICATA ISO 9001 - ISO 14001 E API 7F
CHAIN PRODUCED BY ISO 9001 - ISO 14001 AND API 7F CERTIFIED COMPANY



CATENA PRESTIRATA / PRE-STRETCHED CHAINS

ISO	p		b ₁ mm min.	d ₁ mm max.	a ₂ mm max.	g mm max.	A mm	B mm	C mm max.	D mm	E mm	F mm	Carico di rottura		q kg/m ≈
	mm	inch											minimo KN	medio KN	
06B-1	9,525	3/8"	5,72	6,35	13,5	8,26	8,0	3,5	13,5	9,5	6,5	1,03	9,0	10,7	0,51
08B-1	12,7	1/2"	7,75	8,51	17,0	11,81	9,5	4,3	18,6	14,1	8,4	1,40	18,0	21,1	0,85
10B-1	15,875	5/8"	9,65	10,16	19,6	14,73	14,1	5,2	23,8	15,9	10,4	1,63	22,4	27,4	1,13
12B-1	19,05	3/4"	11,68	12,07	22,7	16,13	15,8	5,6	25,8	17,5	12,0	1,80	29,0	32,3	1,45
16B-1	25,4	1"	17,02	15,88	36,1	21,08	19,0	6,8	37,4	25,4	15,9	3,00	60,0	70,6	3,48

CATENE A RULLI CON ATTACCHI ANGOLARI - DIN 8187 - ISO 606

ROLLER CHAINS WITH ANGLE ATTACHMENTS - DIN 8187 - ISO 606

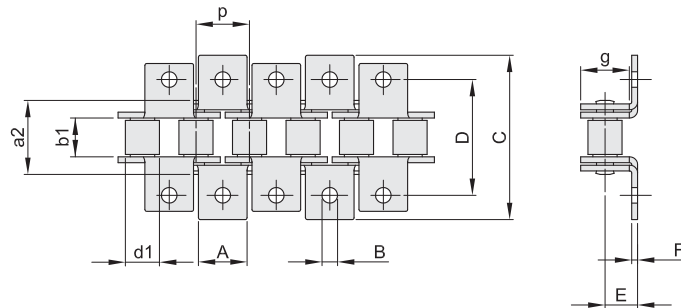

K1/01

CATENA PRODOTTA DA AZIENDA CERTIFICATA ISO 9001 - ISO 14001 E API 7F
CHAIN PRODUCED BY ISO 9001 - ISO 14001 AND API 7F CERTIFIED COMPANY

CATENA PRESTIRATA / PRE-STRETCHED CHAINS

ISO	p		b ₁ mm min.	d ₁ mm max.	a ₂ mm max.	g mm max.	A mm	B mm	C mm max.	D mm	E mm	F mm	Carico di rottura		q kg/m ≈
	mm	inch											minimo KN	medio KN	
06B-1	9,525	3/8"	5,72	6,35	13,5	8,26	8,0	3,5	27,0	19,0	6,5	1,03	9,0	10,7	0,61
08B-1	12,7	1/2"	7,75	8,51	17,0	11,81	9,5	4,3	37,2	28,2	8,4	1,40	18,0	21,1	1,01
10B-1	15,875	5/8"	9,65	10,16	19,6	14,73	14,1	5,2	47,6	31,8	10,4	1,63	22,4	27,4	1,32
12B-1	19,05	3/4"	11,68	12,07	22,7	16,13	15,8	5,6	51,6	35,0	12,0	1,80	29,0	32,3	1,66
16B-1	25,4	1"	17,02	15,88	36,1	21,08	19,0	6,8	74,8	50,8	15,9	3,00	60,0	70,6	4,27

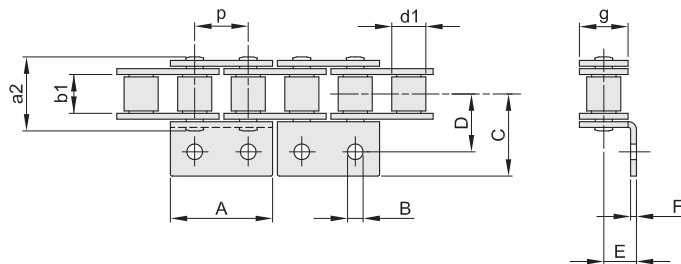

A2/02

CATENA PRODOTTA DA AZIENDA CERTIFICATA ISO 9001 - ISO 14001 E API 7F
CHAIN PRODUCED BY ISO 9001 - ISO 14001 AND API 7F CERTIFIED COMPANY

CATENA PRESTIRATA / PRE-STRETCHED CHAINS

ISO	p		b ₁ mm min.	d ₁ mm max.	a ₂ mm max.	g mm max.	A mm	B mm	C mm max.	D mm	E mm	F mm	Carico di rottura		q kg/m ≈
	mm	inch											minimo KN	medio KN	
06B-1	9,525	3/8"	5,72	6,35	13,5	8,26	17,6	3,5	13,5	9,5	6,5	1,03	9,0	10,7	0,51
08B-1	12,7	1/2"	7,75	8,51	17,0	11,81	23,2	4,3	18,6	14,1	8,4	1,40	18,0	21,1	0,85
10B-1	15,875	5/8"	9,65	10,16	19,6	14,73	29,3	5,2	23,8	15,9	10,4	1,63	22,4	27,4	1,13
12B-1	19,05	3/4"	11,68	12,07	22,7	16,13	33,0	5,6	30,5	17,5	12,0	1,80	29,0	32,3	1,45
16B-1	25,4	1"	17,02	15,88	36,1	21,08	46,0	6,8	39,1	25,4	15,9	3,00	60,0	70,6	3,48

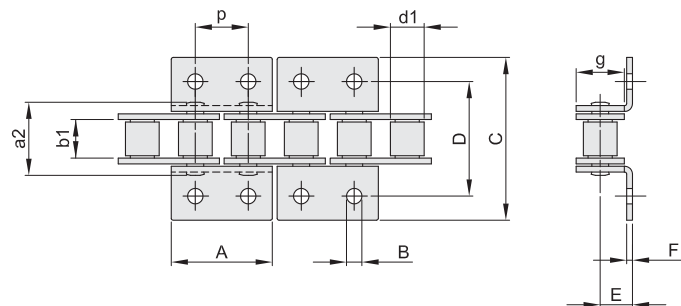

K2/02

CATENA PRODOTTA DA AZIENDA CERTIFICATA ISO 9001 - ISO 14001 E API 7F
CHAIN PRODUCED BY ISO 9001 - ISO 14001 AND API 7F CERTIFIED COMPANY

CATENA PRESTIRATA / PRE-STRETCHED CHAINS

ISO	p		b ₁ mm min.	d ₁ mm max.	a ₂ mm max.	g mm max.	A mm	B mm	C mm max.	D mm	E mm	F mm	Carico di rottura		q kg/m ≈
	mm	inch											minimo KN	medio KN	
06B-1	9,525	3/8"	5,72	6,35	13,5	8,26	17,6	3,5	27,0	19	6,5	1,03	9,0	10,7	0,61
08B-1	12,7	1/2"	7,75	8,51	17,0	11,81	23,2	4,3	37,2	28,2	8,4	1,40	18,0	21,1	1,01
10B-1	15,875	5/8"	9,65	10,16	19,6	14,73	29,3	5,2	47,6	31,8	10,4	1,63	22,4	27,4	1,32
12B-1	19,05	3/4"	11,68	12,07	22,7	16,13	33,0	5,6	61,0	35,0	12,0	1,80	29,0	32,3	1,66
16B-1	25,4	1"	17,02	15,88	36,1	21,08	46,0	6,8	78,2	50,8	15,9	3,00	60,0	70,6	4,27



CATENE A RULLI CON ATTACCHI VERTICALI - DIN 8187 - ISO 606

ROLLER CHAINS WITH VERTICAL ATTACHMENTS - DIN 8187 - ISO 606

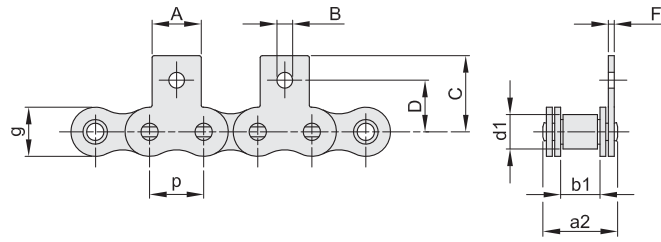

M1/02

CATENA PRODotta DA AZIENDA CERTIFICATA ISO 9001 - ISO 14001 E API 7F
CHAIN PRODUCED BY ISO 9001 - ISO 14001 AND API 7F CERTIFIED COMPANY



CATENA PRESTIRATA / PRE-STRETCHED CHAINS

ISO	p		b ₁ mm min.	d ₁ mm max.	a ₂ mm max.	g mm max.	A mm	B mm	C mm max.	D mm	F mm	Carico di rottura		q kg/m ≈
	mm	inch										minimo KN	medio KN	
06B-1	9,525	3/8"	5,72	6,35	13,5	8,26	8,0	3,5	13,5	9,5	1,03	9,0	10,7	0,46
08B-1	12,7	1/2"	7,75	8,51	17,0	11,81	9,5	4,3	18,4	14,1	1,40	18,0	21,1	0,77
10B-1	15,875	5/8"	9,65	10,16	19,6	14,73	14,1	5,2	24,7	15,9	1,63	22,4	27,4	1,04
12B-1	19,05	3/4"	11,68	12,07	22,7	16,13	15,8	5,6	26,6	17,9	1,80	29,0	32,3	1,35
16B-1	25,4	1"	17,02	15,88	36,1	21,08	19,0	6,8	35,0	26,0	3,00	60,0	70,6	3,09

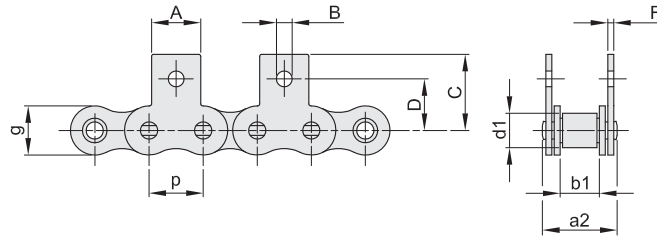

MK1/02

CATENA PRODotta DA AZIENDA CERTIFICATA ISO 9001 - ISO 14001 E API 7F
CHAIN PRODUCED BY ISO 9001 - ISO 14001 AND API 7F CERTIFIED COMPANY



CATENA PRESTIRATA / PRE-STRETCHED CHAINS

ISO	p		b ₁ mm min.	d ₁ mm max.	a ₂ mm max.	g mm max.	A mm	B mm	C mm max.	D mm	F mm	Carico di rottura		q kg/m ≈
	mm	inch										minimo KN	medio KN	
06B-1	9,525	3/8"	5,72	6,35	13,5	8,26	8,0	3,5	13,5	9,5	1,03	9,0	10,7	0,51
08B-1	12,7	1/2"	7,75	8,51	17,0	11,81	9,5	4,3	18,4	14,1	1,40	18,0	21,1	0,85
10B-1	15,875	5/8"	9,65	10,16	19,6	14,73	14,1	5,2	24,7	15,9	1,63	22,4	27,4	1,13
12B-1	19,05	3/4"	11,68	12,07	22,7	16,13	15,8	5,6	26,6	17,9	1,80	29,0	32,3	1,45
16B-1	25,4	1"	17,02	15,88	36,1	21,08	19,0	6,8	35,0	26,0	3,00	60,0	70,6	3,48

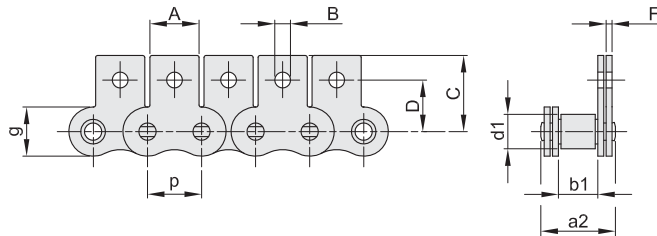

M1/01

CATENA PRODotta DA AZIENDA CERTIFICATA ISO 9001 - ISO 14001 E API 7F
CHAIN PRODUCED BY ISO 9001 - ISO 14001 AND API 7F CERTIFIED COMPANY



CATENA PRESTIRATA / PRE-STRETCHED CHAINS

ISO	p		b ₁ mm min.	d ₁ mm max.	a ₂ mm max.	g mm max.	A mm	B mm	C mm max.	D mm	F mm	Carico di rottura		q kg/m ≈
	mm	inch										minimo KN	medio KN	
06B-1	9,525	3/8"	5,72	6,35	13,5	8,26	8,0	3,5	13,5	9,5	1,03	9,0	10,7	0,51
08B-1	12,7	1/2"	7,75	8,51	17,0	11,81	9,5	4,3	18,4	14,1	1,40	18,0	21,1	0,85
10B-1	15,875	5/8"	9,65	10,16	19,6	14,73	14,1	5,2	24,7	15,9	1,63	22,4	27,4	1,13
12B-1	19,05	3/4"	11,68	12,07	22,7	16,13	15,8	5,6	26,6	17,9	1,80	29,0	32,3	1,45
16B-1	25,4	1"	17,02	15,88	36,1	21,08	19,0	6,8	35,0	26,0	3,00	60,0	70,6	3,48

CATENE A RULLI CON ATTACCHI VERTICALI - DIN 8187 - ISO 606

ROLLER CHAINS WITH VERTICAL ATTACHMENTS - DIN 8187 - ISO 606

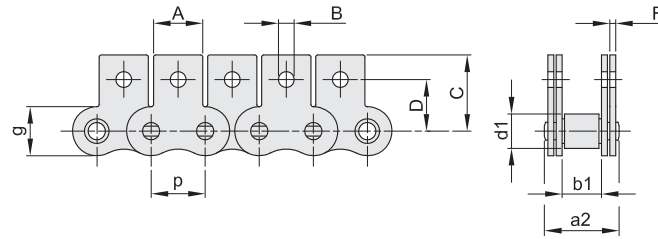

MK1/01

CATENA PRODOTTA DA AZIENDA CERTIFICATA ISO 9001 - ISO 14001 E API 7F
CHAIN PRODUCED BY ISO 9001 - ISO 14001 AND API 7F CERTIFIED COMPANY



CATENA PRESTIRATA / PRE-STRETCHED CHAINS

ISO	p		b ₁ mm min.	d ₁ mm max.	a ₂ mm max.	g mm max.	A mm	B mm	C mm max.	D mm	F mm	Carico di rottura		q kg/m ≈
	mm	inch										minimo KN	medio KN	
06B-1	9,525	3/8"	5,72	6,35	13,5	8,26	8,0	3,5	13,5	9,5	1,03	9,0	10,7	0,61
08B-1	12,7	1/2"	7,75	8,51	17,0	11,81	9,5	4,3	18,4	14,1	1,40	18,0	21,1	1,01
10B-1	15,875	5/8"	9,65	10,16	19,6	14,73	14,1	5,2	24,7	15,9	1,63	22,4	27,4	1,32
12B-1	19,05	3/4"	11,68	12,07	22,7	16,13	15,8	5,6	26,6	17,9	1,80	29,0	32,3	1,66
16B-1	25,4	1"	17,02	15,88	36,1	21,08	19,0	6,8	35,0	26,0	3,00	60,0	70,6	4,27

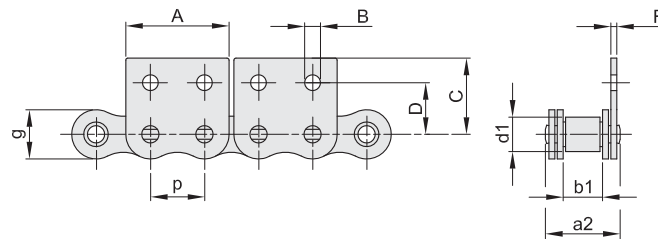

M2/02

CATENA PRODOTTA DA AZIENDA CERTIFICATA ISO 9001 - ISO 14001 E API 7F
CHAIN PRODUCED BY ISO 9001 - ISO 14001 AND API 7F CERTIFIED COMPANY



CATENA PRESTIRATA / PRE-STRETCHED CHAINS

ISO	p		b ₁ mm min.	d ₁ mm max.	a ₂ mm max.	g mm max.	A mm	B mm	C mm max.	D mm	F mm	Carico di rottura		q kg/m ≈
	mm	inch										minimo KN	medio KN	
06B-1	9,525	3/8"	5,72	6,35	13,5	8,26	17,6	3,2	13,5	9,5	1,03	9,0	10,7	0,51
08B-1	12,7	1/2"	7,75	8,51	17,0	11,81	23,2	4,3	18,4	14,1	1,40	18,0	21,1	0,85
10B-1	15,875	5/8"	9,65	10,16	19,6	14,73	29,3	5,2	24,7	15,9	1,63	22,4	27,4	1,13
12B-1	19,05	3/4"	11,68	12,07	22,7	16,13	33,0	5,6	31,3	17,9	1,80	29,0	32,3	1,45
16B-1	25,4	1"	17,02	15,88	36,1	21,08	45,9	6,8	36,6	26,0	3,00	60,0	70,6	3,48

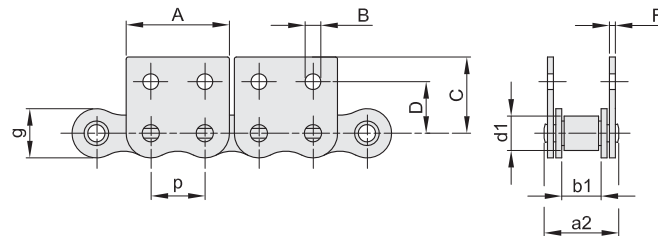

MK2/02

CATENA PRODOTTA DA AZIENDA CERTIFICATA ISO 9001 - ISO 14001 E API 7F
CHAIN PRODUCED BY ISO 9001 - ISO 14001 AND API 7F CERTIFIED COMPANY



CATENA PRESTIRATA / PRE-STRETCHED CHAINS

ISO	p		b ₁ mm min.	d ₁ mm max.	a ₂ mm max.	g mm max.	A mm	B mm	C mm max.	D mm	F mm	Carico di rottura		q kg/m ≈
	mm	inch										minimo KN	medio KN	
06B-1	9,525	3/8"	5,72	6,35	13,5	8,26	17,6	3,2	13,5	9,5	1,03	9,0	10,7	0,61
08B-1	12,7	1/2"	7,75	8,51	17,0	11,81	23,2	4,3	18,4	14,1	1,40	18,0	21,1	1,01
10B-1	15,875	5/8"	9,65	10,16	19,6	14,73	29,3	5,2	24,7	15,9	1,63	22,4	27,4	1,32
12B-1	19,05	3/4"	11,68	12,07	22,7	16,13	33,0	5,6	31,3	17,9	1,80	29,0	32,3	1,66
16B-1	25,4	1"	17,02	15,88	36,1	21,08	45,9	6,8	36,6	26,0	3,00	60,0	70,6	4,27

CATENE A RULLI CON PERNI SPORGENTI - DIN 8187 - ISO 606

EXTENDED PIN CHAINS - DIN 8187 - ISO 606

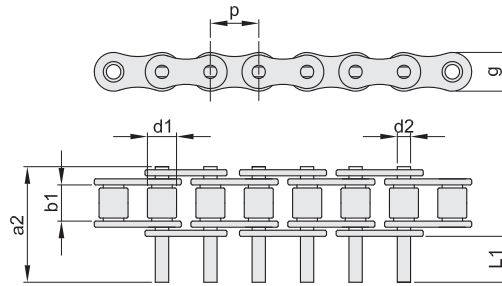

CATENA PRODOTTA DA AZIENDA CERTIFICATA ISO 9001 - ISO 14001 E API 7F
CHAIN PRODUCED BY ISO 9001 - ISO 14001 AND API 7F CERTIFIED COMPANY



CATENA PRESTIRATA / PRE-STRETCHED CHAINS

ISO	p		b ₁ mm min.	d ₂ mm	d ₁ mm max.	L ₁ mm	a ₂ mm max.	g mm max.	Carico di rottura		q kg/m ≈
	mm	inch							minimo KN	medio KN	
06B-1	9,525	3/8"	5,72	3,28	6,35	11,10	22,75	8,26	9,0	10,7	0,47
08B-1	12,7	1/2"	7,75	4,45	8,51	15,15	30,91	11,81	18,0	21,1	0,75
10B-1	15,875	5/8"	9,65	5,08	10,16	17,63	35,26	14,73	22,4	27,4	1,07
12B-1	19,05	3/4"	11,68	5,72	12,07	20,83	41,66	16,13	29,0	32,3	1,22
16B-1	25,4	1"	17,02	8,28	15,88	33,80	67,58	21,08	60,0	70,6	3,03

CATENE PER ACCUMULO

ACCUMULATOR CHAINS

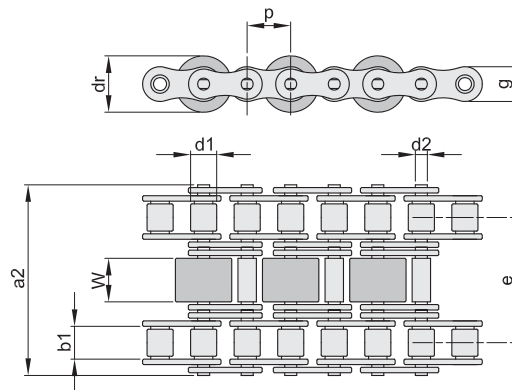

CATENA PRODOTTA DA AZIENDA CERTIFICATA ISO 9001 - ISO 14001 E API 7F
CHAIN PRODUCED BY ISO 9001 - ISO 14001 AND API 7F CERTIFIED COMPANY



CATENA PRESTIRATA / PRE-STRETCHED CHAINS

ISO	p		b ₁ mm min.	d ₂ mm	d ₁ mm max.	a ₂ mm max.	g mm max.	e mm	dr mm max.	W mm	Carico di rottura		q kg/m ≈
	mm	inch									minimo KN	medio KN	
12B-3	19,05	3/4"	11,68	5,72	12,07	61,2	15,82	38,92	28,0	15,5	57,8	59,3	4,04

CATENE A RULLI NICHELATA - DIN 8187 - ISO 606

NICKEL PLATED ROLLER CHAINS - DIN 8187 - ISO 606

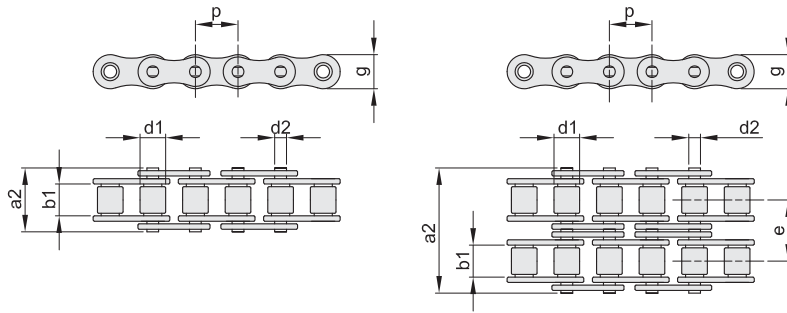

CATENA PRODOTTA DA AZIENDA CERTIFICATA ISO 9001 - ISO 14001 E API 7F
 CHAIN PRODUCED BY ISO 9001 - ISO 14001 AND API 7F CERTIFIED COMPANY

CATENA PRESTIRATA / PRE-STRETCHED CHAINS



SEMPLICE

ISO	p		b ₁ mm min.	d ₂ mm	d ₁ mm max.	a ₂ mm max.	g mm max.	Carico di rottura		q kg/m ≈
	mm	inch						minimo KN	medio KN	
06B-1	9,525	3/8"	5,72	3,28	6,35	13,5	8,26	9,0	10,7	0,40
08B-1	12,7	1/2"	7,75	4,45	8,51	17,0	11,81	18,0	21,1	0,68
10B-1	15,875	5/8"	9,65	5,08	10,16	19,6	14,73	22,4	27,4	0,91
12B-1	19,05	3/4"	11,68	5,72	12,07	22,7	16,13	29,0	32,3	1,12
16B-1	25,4	1"	17,02	8,28	15,88	36,1	21,08	60,0	70,6	2,59



DOPPIA

ISO	p		b ₁ mm min.	d ₂ mm	d ₁ mm max.	a ₂ mm max.	g mm max.	e mm	Carico di rottura		q kg/m ≈
	mm	inch							minimo KN	medio KN	
06B-2	9,525	3/8"	5,72	3,28	6,35	23,8	8,26	10,24	16,9	19,2	0,76
08B-2	12,7	1/2"	7,75	4,45	8,51	31,0	11,81	13,92	32,0	38,0	1,31
10B-2	15,875	5/8"	9,65	5,08	10,16	36,2	14,73	16,59	44,5	57,3	1,79
12B-2	19,05	3/4"	11,68	5,72	12,07	42,2	16,13	19,46	57,8	65,7	2,22
16B-2	25,4	1"	17,02	8,28	15,88	68,0	21,08	31,88	113,7	137,5	5,03

CATENE A RULLI IN ACCIAIO "INOX AISI 304" - DIN 8187 - ISO 606

ROLLER CHAINS IN 304 STAINLESS STEEL - DIN 8187 - ISO 606

La catena INOX (AISI 304), costruita a rulli pieni, offre una particolare resistenza alla corrosione. Può essere utilizzata quindi in ambienti all'acqua, agli agenti chimici ed al calore. Opera a temperature da -20° a +400°.

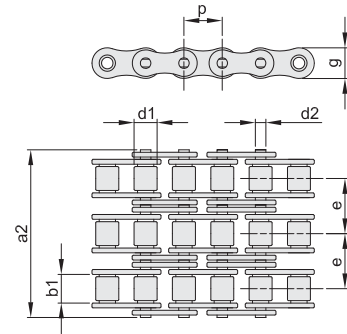
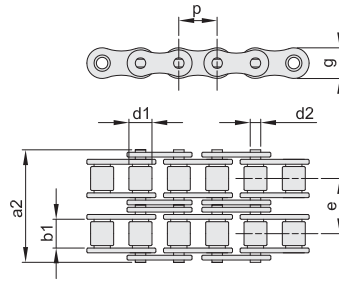
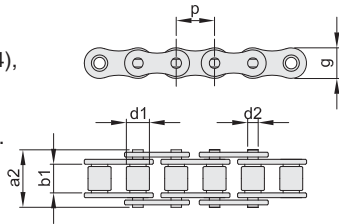

CATENA PRODOTTA DA AZIENDA CERTIFICATA ISO 9001 - ISO 14001 E API 7F
CHAIN PRODUCED BY ISO 9001 - ISO 14001 AND API 7F CERTIFIED COMPANY

CATENA PRESTIRATA / PRE-STRETCHED CHAINS



SEMPLICE

ISO	p		b ₁ mm min.	d ₂ mm	d ₁ mm max.	a ₂ mm max.	g mm max.	Carico di rottura		q kg/m ≈
	mm	inch						minimo KN	medio KN	
06B-1	9,525	3/8"	5,72	3,28	6,35	13,5	8,26	6,6	6,9	0,40
08B-1	12,7	1/2"	7,75	4,45	8,51	17,0	11,81	12,0	12,7	0,68
10B-1	15,875	5/8"	9,65	5,08	10,16	19,6	14,73	15,0	16,8	0,91
12B-1	19,05	3/4"	11,68	5,72	12,07	22,7	16,13	17,0	17,5	1,12
16B-1	25,4	1"	17,02	8,28	15,88	36,1	21,08	40,0	41,0	2,59

DOPPIA

ISO	p		b ₁ mm min.	d ₂ mm	d ₁ mm max.	a ₂ mm max.	g mm max.	e mm	Carico di rottura		q kg/m ≈
	mm	inch							minimo KN	medio KN	
06B-2	9,525	3/8"	5,72	3,28	6,35	23,8	8,26	10,24	10,5	12,8	0,76
08B-2	12,7	1/2"	7,75	4,45	8,51	31,0	11,81	13,92	22,0	24,4	1,31
10B-2	15,875	5/8"	9,65	5,08	10,16	36,2	14,73	16,59	28,4	33,8	1,79
12B-2	19,05	3/4"	11,68	5,72	12,07	42,2	16,13	19,46	33,3	35,6	2,22
16B-2	25,4	1"	17,02	8,28	15,88	68,0	21,08	31,88	74,4	79,0	5,03

TRIPLA

ISO	p		b ₁ mm min.	d ₂ mm	d ₁ mm max.	a ₂ mm max.	g mm max.	e mm	Carico di rottura		q kg/m ≈
	mm	inch							minimo KN	medio KN	
06B-3	9,525	3/8"	5,72	3,28	6,35	34,0	8,26	10,24	17,8	18,6	1,12
08B-3	12,7	1/2"	7,75	4,45	8,51	44,9	11,81	13,92	30,6	31,8	1,94
10B-3	15,875	5/8"	9,65	5,08	10,16	52,8	14,73	16,59	42,6	49,5	2,68
12B-3	19,05	3/4"	11,68	5,72	12,07	61,7	16,13	19,46	50,0	52,2	3,32
16B-3	25,4	1"	17,02	8,28	15,88	99,9	21,08	31,88	111,7	117,6	7,65

CATENE A RULLI CON PIASTRE A PROFILO DIRITTO IN ACCIAIO "INOX AISI 304" - DIN 8187 - ISO 606
ROLLER CHAINS IN 304 STAINLESS STEEL WITH STRAIGHT PLATES - DIN 8187 - ISO 606

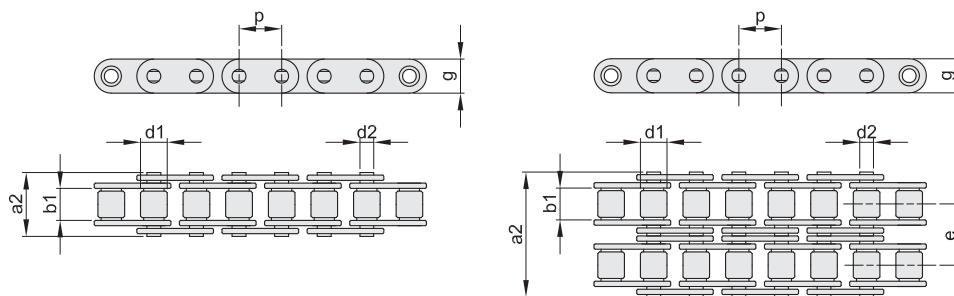

CATENA PRODOTTA DA AZIENDA CERTIFICATA ISO 9001 - ISO 14001 E API 7F
 CHAIN PRODUCED BY ISO 9001 - ISO 14001 AND API 7F CERTIFIED COMPANY

CATENA PRESTIRATA / PRE-STRETCHED CHAINS



SEMPLICE

ISO	p		b ₁ mm min.	d ₂ mm	d ₁ mm max.	a ₂ mm max.	g mm max.	Carico di rottura		q kg/m ≈
	mm	inch						minimo KN	medio KN	
08B-1	12,7	1/2"	7,75	4,45	8,51	17,0	11,6	12,0	12,7	0,78
12B-1	19,05	3/4"	11,68	5,72	12,07	22,7	15,9	17,0	17,5	1,30

DOPPIA

ISO	p		b ₁ mm min.	d ₂ mm	d ₁ mm max.	a ₂ mm max.	g mm max.	e mm	Carico di rottura		q kg/m ≈
	mm	inch							minimo KN	medio KN	
08B-2	12,7	1/2"	7,75	4,45	8,51	31,0	11,6	13,92	22,0	24,4	1,55

CATENE A PERNI FORATI IN ACCIAIO "INOX AISI 304" - DIN 8187 - ISO 606
CHAINS IN 304 STAINLESS STEEL WITH HOLLOW PINS - DIN 8187 - ISO 606

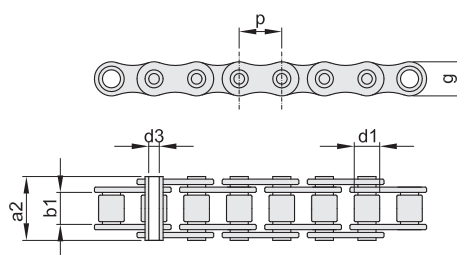

A RULLI

CATENA PRODOTTA DA AZIENDA CERTIFICATA ISO 9001 - ISO 14001 E API 7F
 CHAIN PRODUCED BY ISO 9001 - ISO 14001 AND API 7F CERTIFIED COMPANY

CATENA PRESTIRATA / PRE-STRETCHED CHAINS



ISO	p		b ₁ mm min.	d ₃ mm	d ₁ mm max.	a ₂ mm max.	g mm max.	Carico di rottura		q kg/m ≈
	mm	inch						minimo KN	medio KN	
08B-1	12,7	1/2"	7,75	4,50	8,51	17,0	11,6	8,3	10,6	0,58
10B-1	15,875	5/8"	9,65	5,18	10,16	19,6	14,5	11,8	13,9	0,77
12B-1	19,05	3/4"	11,68	5,85	12,07	22,7	15,9	12,0	17,2	0,98
16B-1	25,4	1"	17,02	8,33	15,88	36,1	20,5	20,0	36,0	2,21

CATENE A RULLI SERIE EUROPEA "SATURN"- DIN 8187 - ISO 606

ROLLER CHAINS EUROPEAN STANDARD "SATURN"- DIN 8187 - ISO 606

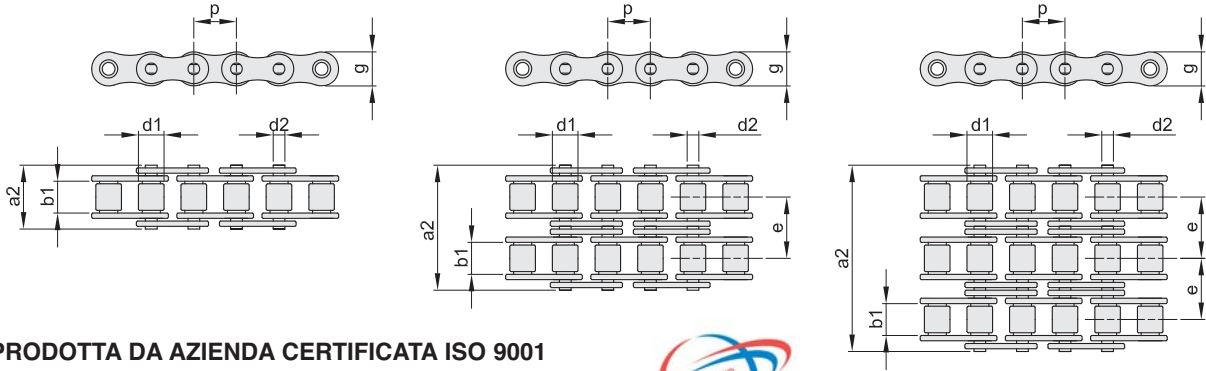

CATENA PRODOTTA DA AZIENDA CERTIFICATA ISO 9001
CHAIN PRODUCED BY ISO 9001 CERTIFIED COMPANY



CATENA PRESTIRATA / PRE-STRETCHED CHAINS

SEMPLICE

ISO	p		b ₁ mm min.	d ₂ mm	d ₁ mm max.	a ₂ mm max.	g mm max.	F _B min KN	q kg/m ≈
	mm	inch							
04-1	6	-	2,80	1,85	4,00	7,4	5,00	3,0	0,12
05B-1	8	-	3,00	2,31	5,00	8,6	7,11	4,4	0,18
06B-1 ▲	9,525	3/8"	5,72	3,28	6,35	13,5	8,26	8,9	0,40
081-1 ▲	12,7	1/2"	3,30	3,66	7,75	10,2	9,91	8,0	0,28
083-1	12,7	1/2"	4,88	4,09	7,75	12,9	10,30	11,6	0,42
084-1	12,7	1/2"	4,88	4,09	7,75	14,8	11,15	15,6	0,49
08B-1 ▲	12,7	1/2"	7,75	4,45	8,51	17,0	11,81	17,8	0,68
10B-1 ▲	15,875	5/8"	9,65	5,08	10,16	19,6	14,73	22,2	0,91
12B-1	19,05	3/4"	11,68	5,72	12,07	22,7	16,13	28,9	1,12
16B-1	25,4	1"	17,02	8,28	15,88	36,1	21,08	60,0	2,59
20B-1	31,75	1"1/4	19,56	10,19	19,05	43,2	26,42	95,0	3,68
24B-1	38,1	1"1/2	25,40	14,63	25,40	53,4	33,40	160,0	6,85
28B-1	44,45	1"3/4	30,99	15,90	27,94	65,1	37,08	200,0	8,56
32B-1	50,8	2"	30,99	17,81	29,21	67,4	42,29	250,0	9,49
40B-1	63,5	2"1/2	38,10	22,89	39,37	82,6	52,90	355,0	15,55
48B-1	76,2	3"	45,72	29,24	48,26	99,1	63,80	560,0	24,45

▲ Fornita anche in rotoli/Supplied also in reels.

DOPPIA

ISO	p		b ₁ mm min.	d ₂ mm	d ₁ mm max.	a ₂ mm max.	g mm max.	e mm	F _B min KN	q kg/m ≈
	mm	inch								
05B-2	8	-	3,00	2,31	5,00	14,3	7,11	5,64	7,8	0,32
06B-2	9,525	3/8"	5,72	3,28	6,35	23,8	8,26	10,24	16,9	0,76
08B-2	12,7	1/2"	7,75	4,45	8,51	31,0	11,81	13,92	31,1	1,31
10B-2	15,875	5/8"	9,65	5,08	10,16	36,2	14,73	16,59	44,5	1,79
12B-2	19,05	3/4"	11,68	5,72	12,07	42,2	16,13	19,46	57,8	2,22
16B-2	25,4	1"	17,02	8,28	15,88	68,0	21,08	31,88	106,0	5,03
20B-2	31,75	1"1/4	19,56	10,19	19,05	79,7	26,42	36,45	170,0	7,33
24B-2	38,1	1"1/2	25,40	14,63	25,40	101,8	33,40	48,36	280,0	13,50
28B-2	44,45	1"3/4	30,99	15,90	27,94	124,7	37,08	59,56	360,0	16,96
32B-2	50,8	2"	30,99	17,81	29,21	126,0	42,99	58,55	450,0	18,74
40B-2	63,5	2"1/2	38,10	22,89	39,37	154,0	52,90	72,29	630,0	30,72
48B-2	76,2	3"	45,72	29,24	48,26	190,0	63,80	91,21	1000,0	48,54

TRIPLA

ISO	p		b ₁ mm min.	d ₂ mm	d ₁ mm max.	a ₂ mm max.	g mm max.	e mm	F _B min KN	q kg/m ≈
	mm	inch								
06B-3	9,525	3/8"	5,72	3,28	6,35	34,0	8,26	10,24	24,9	1,12
08B-3	12,7	1/2"	7,75	4,45	8,51	44,9	11,81	13,92	44,5	1,94
10B-3	15,875	5/8"	9,65	5,08	10,16	52,8	14,73	16,59	66,7	2,68
12B-3	19,05	3/4"	11,68	5,72	12,07	61,7	16,13	19,46	86,7	3,32
16B-3	25,4	1"	17,02	8,28	15,88	99,9	21,08	31,88	160,0	7,65
20B-3	31,75	1"1/4	19,56	10,19	19,05	116,1	26,42	36,45	250,0	10,96
24B-3	38,1	1"1/2	25,40	14,63	25,40	150,2	33,40	48,36	425,0	20,20
28B-3	44,45	1"3/4	30,99	15,90	27,94	184,3	37,08	59,56	530,0	25,38
32B-3	50,8	2"	30,99	17,81	29,21	184,5	42,99	58,55	670,0	28,04
40B-3	63,5	2"1/2	38,10	22,89	39,37	227,0	52,90	72,29	950,0	45,90
48B-3	76,2	3"	45,72	29,24	48,26	281,0	63,80	91,21	1500,0	72,50

CATENE A RULLI CON PIASTRE A PROFILO DIRITTO "SATURN" - DIN 8187 - ISO 606

ROLLER CHAINS WITH STRAIGHT PLATES "SATURN" - DIN 8187 - ISO 606

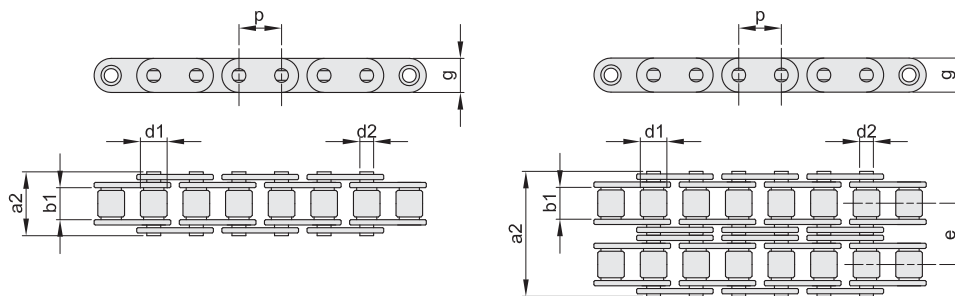

CATENA PRODOTTA DA AZIENDA CERTIFICATA ISO 9001
CHAIN PRODUCED BY ISO 9001 CERTIFIED COMPANY

CATENA PRESTIRATA / PRE-STRETCHED CHAINS



SEMPLICE

ISO	p		b ₁ mm min.	d ₂ mm	d ₁ mm max.	a ₂ mm max.	g mm max.	F _B min KN	q kg/m ≈
	mm	inch							
08B-1	12,7	1/2"	7,75	4,45	8,51	17,0	11,5	17,8	0,75
10B-1	15,875	5/8"	9,65	5,08	10,16	19,6	13,9	22,2	0,98
12B-1	19,05	3/4"	11,68	5,72	12,07	22,7	16,1	28,9	1,24
16B-1	25,4	1"	17,02	8,28	15,88	36,1	21,0	60,0	3,30

DOPPIA

ISO	p		b ₁ mm min.	d ₂ mm	d ₁ mm max.	a ₂ mm max.	g mm max.	e mm	F _B min KN	q kg/m ≈
	mm	inch								
10B-2	15,875	5/8"	9,65	5,08	10,16	36,2	13,9	16,59	44,5	1,97
12B-2	19,05	3/4"	11,68	5,72	12,07	42,2	16,1	19,46	57,8	2,27
16B-2	25,4	1"	17,02	8,28	15,88	68,0	21,0	31,88	106,0	5,78

CATENE A RULLI IN ACCIAIO "INOX AISI 304 - "SATURN - DIN 8187 - ISO 606

ROLLER CHAINS IN 304 STAINLESS STEEL - "SATURN"- DIN 8187 - ISO 606

La catena INOX (AISI 304), costruita a rulli pieni, offre una particolare resistenza alla corrosione. Può essere utilizzata quindi in ambienti all'acqua, agli agenti chimici ed al calore. Opera a temperature da -20° a +400°.

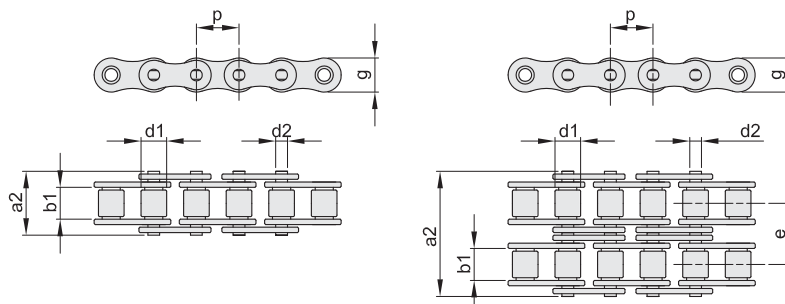

CATENA PRODOTTA DA AZIENDA CERTIFICATA ISO 9001
CHAIN PRODUCED BY ISO 9001



CATENA PRESTIRATA / PRE-STRETCHED CHAINS

SEMPLICE

ISO	p		b ₁ mm min.	d ₂ mm	d ₁ mm max.	a ₂ mm max.	g mm max.	F _B min KN	q kg/m ≈
	mm	inch							
06B-1	9,525	3/8"	5,72	3,28	6,35	13,5	8,26	6,6	0,40
08B-1	12,7	1/2"	7,75	4,45	8,51	17,0	11,81	12,0	0,68
10B-1	15,875	5/8"	9,65	5,08	10,16	19,6	14,73	15,0	0,91
12B-1	19,05	3/4"	11,68	5,72	12,07	22,7	16,13	17,0	1,12
16B-1	25,4	1"	17,02	8,28	15,88	36,1	21,08	40,0	2,59

DOPPIA

ISO	p		b ₁ mm min.	d ₂ mm	d ₁ mm max.	a ₂ mm max.	g mm max.	e mm	F _B min KN	q kg/m ≈
	mm	inch								
06B-2	9,525	3/8"	5,72	3,28	6,35	23,8	8,26	10,24	10,5	0,76
08B-2	12,7	1/2"	7,75	4,45	8,51	31,0	11,81	13,92	22,0	1,31
10B-2	15,875	5/8"	9,65	5,08	10,16	36,2	14,73	16,59	28,4	1,79
12B-2	19,05	3/4"	11,68	5,72	12,07	42,2	16,13	19,46	33,3	2,22
16B-2	25,4	1"	17,02	8,28	15,88	68,0	21,08	31,88	74,4	5,03

GUIDACATENE IN POLIETILENE

CHAIN GUIDE RAILS IN POLYETHYLENE

PROFILO "T" PER CATENA SEMPLICE

codice	catena	ISO	B	A	b	a	Kg./Mt.
T 0	3/8" x 7/32"	06B1	15	10	5,4	1,5	0,13
T 1	1/2" x 5/16"	08B1	20	10	7,4	2,2	0,18
T 1	1/2" x 5/16"	08B1	20	15	7,4	2,2	0,26
T 1	1/2" x 5/16"	08B1	20	20	7,4	2,2	0,34
T 2	5/8" x 3/8"	10B1	20	10	9,2	2,6	0,16
T 2	5/8" x 3/8"	10B1	20	15	9,2	2,6	0,25
T 2	5/8" x 3/8"	10B1	20	20	9,2	2,6	0,33
T 3	3/4" x 7/16"	12B1	25	10	11,3	2,4	0,20
T 3	3/4" x 7/16"	12B1	25	15	11,3	2,4	0,32
T 3	3/4" x 7/16"	12B1	25	20	11,3	2,4	0,43
T 4	1" x 17,02 mm	16B1	40	15	16,5	3,5	0,45
T 4	1" x 17,02 mm	16B1	40	20	16,5	3,5	0,68
T 5	1" 1/4 x 3/4"	20B1	45	15	19,0	4,3	0,55
T 5	1" 1/4 x 3/4"	20B1	45	20	19,0	4,3	0,77
T 6	1" 1/2 x 1"	24B1	60	15	24,6	5,6	0,67
T 6	1" 1/2 x 1"	24B1	60	20	24,6	5,6	0,97
* T 7	1" 3/4 x 1" 1/4	28B1	75	20	30,0	6,9	
* T 8	2" x 1" 1/4	32B1	80	20	30,0	7,8	

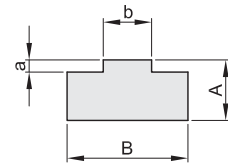

PROFILO "T" PER CATENA DOPPIA

codice	catena	ISO	B	A	b	a	c	Kg./Mt.
T 0.2	3/8" x 7/32"	06B2	25	10	5,4	1,5	15,74	0,22
T 1.2	1/2" x 5/16"	08B2	35	10	7,4	2,2	21,42	0,30
T 1.2	1/2" x 5/16"	08B2	35	15	7,4	2,2	21,42	0,46
T 1.2	1/2" x 5/16"	08B2	35	20	7,4	2,2	21,42	0,63
T 2.2	5/8" x 3/8"	10B2	40	10	9,2	2,6	25,79	0,32
T 2.2	5/8" x 3/8"	10B2	40	15	9,2	2,6	25,79	0,54
T 2.2	5/8" x 3/8"	10B2	40	20	9,2	2,6	25,79	0,77
T 3.2	3/4" x 7/16"	12B2	45	15	11,3	2,4	30,76	0,62
T 3.2	3/4" x 7/16"	12B2	45	20	11,3	2,4	30,76	0,85
T 4.2	1" x 17,02 mm	16B2	65	15	16,5	3,5	48,38	0,86
T 4.2	1" x 17,02 mm	16B2	65	20	16,5	3,5	48,38	1,19
T 5.2	1" 1/4 x 3/4"	20B2	70	15	19,0	4,3	54,45	0,89
T 5.2	1" 1/4 x 3/4"	20B2	70	20	19,0	4,3	54,45	1,22
T 6.2	1" 1/2 x 1"	24B2	88	20	24,6	5,6	72,96	1,48
* T 7.2	1" 3/4 x 1" 1/4	28B2	105	25	30,0	6,9	89,56	
* T 8.2	2" x 1" 1/4	32B2	105	30	30,0	7,8	88,55	

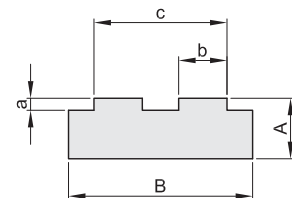

PROFILO "T" PER CATENA TRIPLA

codice	catena	ISO	B	A	b	a	c	Kg./Mt.
T 0.3	3/8" x 7/32"	06B3	35	10	5,4	1,5	25,88	0,77
T 1.3	1/2" x 5/16"	08B3	45	10	7,4	2,2	35,24	0,82
T 1.3	1/2" x 5/16"	08B3	45	15	7,4	2,2	35,24	1,06
T 1.3	1/2" x 5/16"	08B3	45	20	7,4	2,2	35,24	1,27
T 2.3	5/8" x 3/8"	10B3	55	10	9,2	2,6	42,38	0,85
T 2.3	5/8" x 3/8"	10B3	55	15	9,2	2,6	42,38	1,13
T 2.3	5/8" x 3/8"	10B3	55	20	9,2	2,6	42,38	1,40
T 3.3	3/4" x 7/16"	12B3	60	15	11,3	2,4	50,22	0,86
T 3.3	3/4" x 7/16"	12B3	60	20	11,3	2,4	50,22	1,16
T 4.3	1" x 17,02 mm	16B3	95	20	16,5	3,5	80,26	1,75

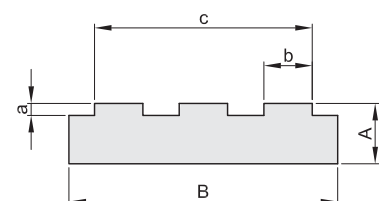

* Costruiti a richiesta - Manufactured on request.

GUIDACATENE IN POLIETILENE CHAIN GUIDE RAILS IN POLYETHYLENE

PROFILO "E" PER CATENA SEMPLICE

codice	catena	ISO	B	A	a	a1	b	b1	Kg./Mt.
E 0	3/8" x 7/32"	06B1	25	10	1,5	4,35	5,4	15	0,17
E 1	1/2" x 5/16"	08B1	30	15	2,2	7,17	7,4	20	0,27
E 2	5/8" x 3/8"	10B1	33	20	2,6	9,45	9,2	23	0,39
E 3	3/4" x 7/16"	12B1	38	20	2,4	11,11	11,3	28	0,39
E 4	1" x 17,02 mm	16B1	51	25	3,5	16,48	16,5	41	0,46

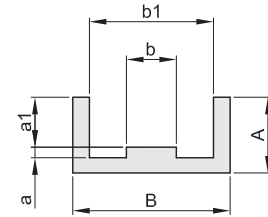

PROFILO "E" PER CATENA DOPPIA

codice	catena	ISO	B	A	a	a1	b	c1	Kg./Mt.
E 0.2	3/8" x 7/32"	06B2	36	15	1,5	4,35	5,4	26	0,43
E 1.2	1/2" x 5/16"	08B2	45	20	2,2	7,17	7,4	35	0,59
E 2.2	5/8" x 3/8"	10B2	50	25	2,6	9,45	9,2	40	0,77
E 3.2	3/4" x 7/16"	12B2	56	25	2,4	11,11	11,3	46	0,80
E 4.2	1" x 17,02 mm	16B2	85	30	3,5	16,48	16,5	75	1,12

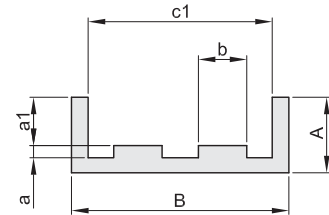

PROFILO "BL" PER CATENA SEMPLICE

codice	catena	ISO	B	A	a1	a2	a3	d1	D	d2	Kg./Mt.
BL 0	3/8" x 7/32"	06B1	20	25	5,6	8,7	10,0	6,6	9,3	4,0	0,43
BL 1	1/2" x 5/16"	08B1	24	30	7,6	11,5	13,5	8,7	12,8	5,0	0,55
BL 2	5/8" x 3/8"	10B1	30	35	9,5	13,5	14,8	10,4	15,4	6,0	0,83
BL 3	3/4" x 7/16"	12B1	40	35	11,5	15,9	17,5	12,3	16,9	7,0	1,10
BL 4	1" x 17,02 mm	16B1	40	45	16,9	25,7	26,8	16,1	24,4	9,0	1,22
* BL 5	1" 1/4 x 3/4"	20B1	50	50	19,4	29,3	31,2	19,3	27,5	11,0	
* BL 6	1" 1/2 x 1"	24B1	60	60	25,2	38,2	40,1	25,7	36,5	16,0	
* BL 7	1" 3/4 x 1" 1/4	28B1	60	70	30,8	46,9	48,9	28,3	41,5	17,0	
* BL 8	2" x 1" 1/4	32B1	70	75	30,8	47,3	53,0	29,6	44,5	19,0	

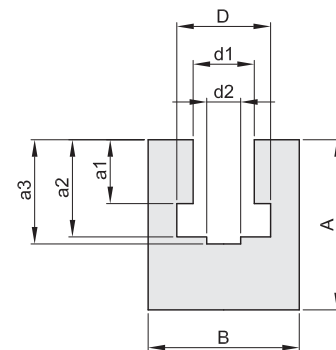

PROFILO "U" PER CATENA SEMPLICE

codice	catena	ISO	B	A	a2	a3	d1	d2	Kg./Mt.
U 0	3/8" x 7/32"	06B1	20	15	2,8	4,2	9,2	4	0,26
U 1	1/2" x 5/16"	08B1	25	15	3,5	4,8	12,7	5	0,31
U 2	5/8" x 3/8"	10B1	25	15	3,6	5,1	15,2	6	0,30
U 3	3/4" x 7/16"	12B1	25	20	3,9	5,7	16,7	7	0,40
U 4	1" x 17,02 mm	16B1	35	25	8,4	10,0	24,4	9	0,63

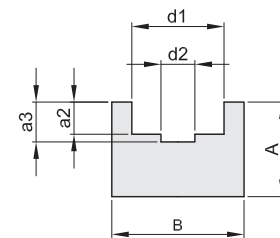

PROFILO "CT" PER CATENA SEMPLICE

codice	catena	ISO	B	A	a	b	Ac	Kg./Mt.
T 0 C3 A 15	3/8" x 7/32"	06B1	20	15	1,5	5,4	17	0,86
T 1 C3 A 15	1/2" x 5/16"	08B1	20	15	2,2	7,4	17	0,85
T 2 C3 A 15	5/8" x 3/8"	10B1	20	15	2,6	9,2	17	0,85
T 3 C3 A 15	3/4" x 7/16"	12B1	20	15	2,4	11,3	17	0,84
T 4 C5 A 15	1" x 17,02 mm	16B1	28	15	3,5	16,5	18	1,24
T 5 C9 A 20	1 1/4" x 3/4"	20B1	38	20	4,3	19,0	27	2,40

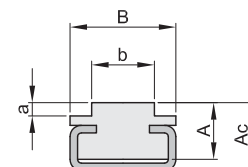

* Costruiti a richiesta - Manufactured on request.

GUIDACATENE IN POLIETILENE

CHAIN GUIDE RAILS IN POLYETHYLENE

PROFILO "CT" PER CATENA DOPPIA

codice	catena	ISO	B	A	a	b	Ac	Kg./Mt.
T 0.2 C3 A 15	3/8" x 7/32"	06B2	15,7	15	1,5	5,4	17	0,74
T 1.2 C3 A 15	1/2" x 5/16"	08B2	21,4	15	2,2	7,4	17	0,84
T 2.2 C5 A 15	5/8" x 3/8"	10B2	25,9	15	2,6	9,2	19	0,85
T 3.2 C5 A 15	3/4" x 7/16"	12B2	30,7	15	2,4	11,3	19	1,25
T 4.2 C9 A 20	1" x 17,02 mm	16B2	48,3	20	3,5	16,5	27	2,15

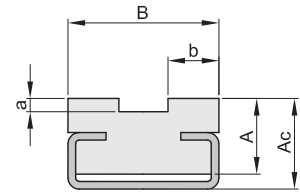

PROFILO "C 10 P" PER CATENA SEMPLICE

codice	catena	ISO	B	A	b	a	Kg./Mt.
C 10.0	3/8" x 7/32"	06B1	30	24	6,6	5,6	1,31
C 10.1	1/2" x 5/16"	08B1	30	24	8,7	7,6	1,30
C 10.2	5/8" x 3/8"	10B1	30	24	10,4	9,5	1,29
C 10.3	3/4" x 7/16"	12B1	30	24	12,3	11,5	1,28
C 11.4	1" x 17,02 mm	16B1	45	40	16,1	16,9	2,88

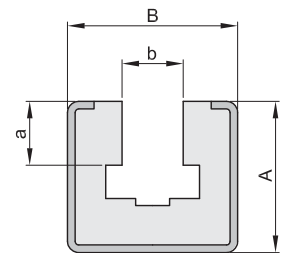

PROFILO "COMBI A-R" PER CATENA SEMPLICE

codice	catena	ISO	Prof. met.	A	B	A1	A2	Ac	b	Kg./Mt.
COMBI 0	3/8" x 7/32"	06B1	C 3	26,4	20	31,6	19,5	28,4	17,3	0,89
COMBI 1	1/2" x 5/16"	08B1	C 3	28,0	20	34,8	18,9	30,5	16,5	0,96
COMBI 2	5/8" x 3/8"	10B1	C 3	33,0	20	41,1	21,2	36,0	15,5	1,12
COMBI 3	3/4" x 7/16"	12B1	C 5	38,5	28	47,5	24,8	41,5	22,3	1,72
COMBI 4	1" x 17,02 mm	16B1	C 9	52,4	38	69,4	34,0	61,4	29,7	2,80

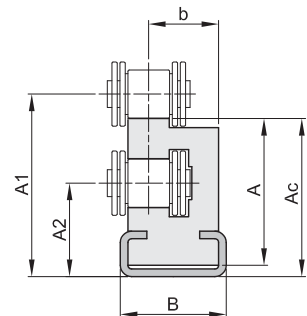

PROFILI METALLICI - ZINCATI

codice	A	B	C	S	Kg./Mt.
C3	10	20	10	1,5	0,48
C5	12	28	14	1,5	0,85
C9	18	38	22	1,5	0,90
C10	24	30	20	1,5	0,95
C11	40	45	31	2	1,95

C3 - C5 - C9 - C10 disponibile anche in AISI 304

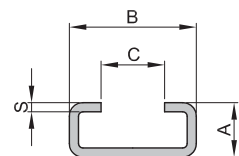

CARATTERISTICHE TECNICHE POLIETILENE

MATERIALE : PE UHMW Polietilene ad altissima densità.
 PESO SPECIFICO : 0,94 gr/cm³
 DUREZZA : Shore D 64/67

TEMPERATURA D'IMPIEGO : Fino a 80° C
 COEFFICIENTE : mm/° c 2 x 10⁻⁴
 DI DILATAZIONE TERMICA (2 mm/mt per ogni 10° C)

Caratteristiche del sistema elastico universale
 Characteristics of the rubber suspension units

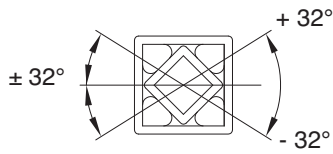

Ampio angolo d'azione
 Large operating angle

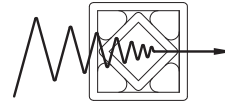

Riduzione di rumore e vibrazioni
 Noise and vibration damping

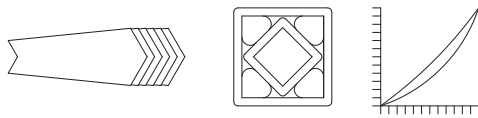

Progressiva elasticità
 Progressive spring characteristics

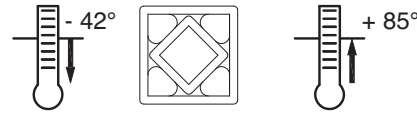

Resistenza alle temperature
 Resistant to temperature

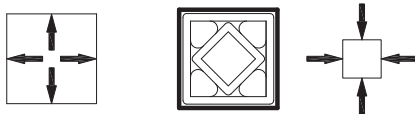

Sicurezza dell'utilizzo
 Safe use in any position



Non necessita di manutenzione
 Maintenance free

Istruzioni per il corretto montaggio del tendicatena (TEKS) e dei tendicinghia (TERE)

Instructions for a proper mounting of the chain tensioner (TEKS) and of the belt tensioner (TERE)

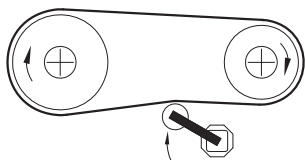

ruota condotta
 driven wheel

Tenditore sul lato lasco
 Tensioner on the loose side

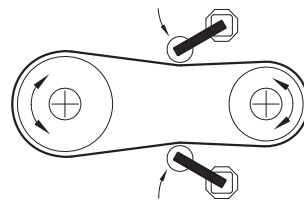

Con motore reversibile
montare 2 tendicatena
 With reversible engine mount
 2 tensioners

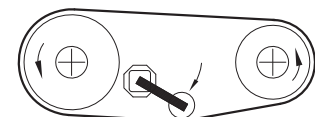

ruota condotta
 driven wheel

Montaggio con trasmissione
a cinghia con profilo a V
 Mounting with belt transmission
 with V profile

Caratteristiche della gomma
 Characteristics of the rubber

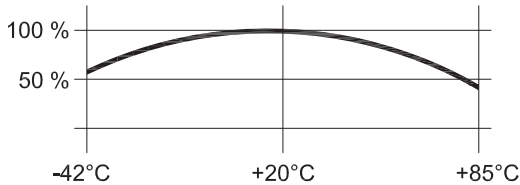

Temperatura ambiente
 Room temperature

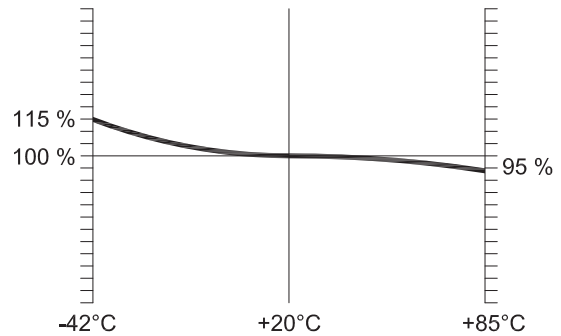

Temperatura ambiente
 Room temperature

Durata in condizioni normali di temperatura ~ 10 anni
 Temperature influence: service life (under normal conditions) ~ 10 years

Influenza della temperatura: coppia di reazione (N/m)
 Temperature influence: torque reaction (N/m)

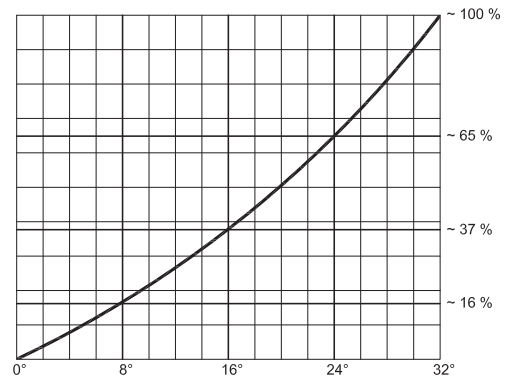
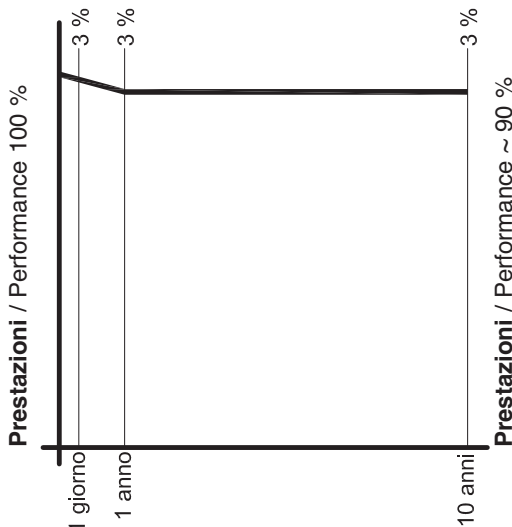

Determinazione della coppia "in percentuale"
 Torque determination "in percentage"

Deformazioni e assestamento della gomma
 Could flow and setting

Il grafico è applicabile per tutte le dimensioni dei tipi: LTK-S, LTK-A, LTS, LTA

This chart is applicable to all type of: LTK-S, LTK-A, LTS, LTA

Esempio per la determinazione LTS 6-80 con coppia M 215 in Nm a 32° (pag 134)

Example for determinating LTS 6-80 with torque M 215 with Nm a 32° (page 134)

Con angolo di 15° = 35% = ~ 75 Nm

With an angle of 15° = 35% = ~ 75 Nm

Con angolo di 22° = 56% = ~ 120 Nm

With an angle of 22° = 56% = ~ 120 Nm

Con angolo di 28° = 81% = ~ 174 Nm

With an angle of 28° = 81% = ~ 174 Nm

SEMPLICI

codice	catena	ISO	denti	A	B	Kg.
TEKS 3	3/8" x 7/32"	06B1	15	20 ÷ 50	M10	0,60
TEKS 3	1/2" x 5/16"	08B1	15	20 ÷ 50	M10	0,65
TEKS 5	5/8" x 3/8"	10B1	15	26 ÷ 67	M12	2,32
TEKS 5	3/4" x 7/16"	12B1	15	26 ÷ 67	M12	2,55
TEKS 6	1" x 17,02 mm	16B1	13	37 ÷ 102	M20	5,00
TEKS 7	1"1/4 x 3/4"	20B1	13	39 ÷ 122	M20	8,55
TEKS 7	1"1/2 x 1"	24B1	11	39 ÷ 142	M20	8,90

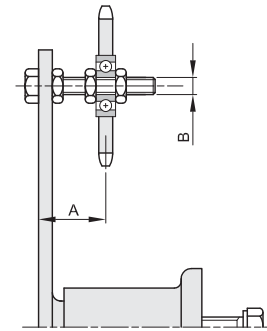

DOPPI

codice	catena	ISO	denti	A	B	Kg.
TEKS 3	3/8" x 7/32"	06B2	15	25 ÷ 44	M10	0,65
TEKS 4	1/2" x 5/16"	08B2	15	27 ÷ 43	M10	1,15
TEKS 5	5/8" x 3/8"	10B2	15	34 ÷ 59	M12	2,55
TEKS 5	3/4" x 7/16"	12B2	15	36 ÷ 57	M12	3,00
TEKS 6	1" x 17,02 mm	16B2	13	52 ÷ 86	M20	5,80
TEKS 7	1"1/4 x 3/4"	20B2	13	57 ÷ 104	M20	10,10
TEKS 7	1"1/2 x 1"	24B2	11	63 ÷ 118	M20	10,75

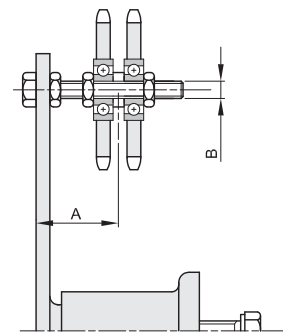

TRIPLI

codice	catena	ISO	denti	A	B	Kg.
TEKS 4	3/8" x 7/32"	06B3	15	31 ÷ 39	M10	0,95
TEKS 5	1/2" x 5/16"	08B3	15	40 ÷ 53	M12	2,45
TEKS 6	5/8" x 3/8"	10B3	15	53 ÷ 85	M20	4,95
TEKS 6	3/4" x 7/16"	12B3	15	56 ÷ 83	M20	5,20
TEKS 7	1" x 17,02 mm	16B3	13	70 ÷ 70	M20	9,40
TEKS 7	1"1/4 x 3/4"	20B3	13	75 ÷ 86	M20	11,70
TEKS 7	1"1/2 x 1"	24B3	11	87 ÷ 94	M20	12,70

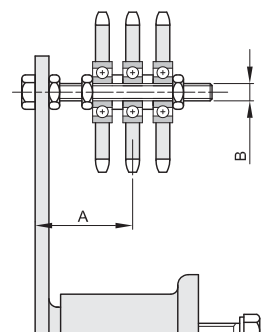

TENDICATENA UNIVERSALI TIPO "TECRS"

UNIVERSAL CHAIN TENSIONERS TYPE "TECRS"



SEMPLICI

codice	catena	ISO	A	B	Kg.
TECRS 2	3/8" x 7/32"	06B1	18 ÷ 35	M 8	0,30
TECRS 3	1/2" x 5/16"	08B1	23 ÷ 45	M10	0,56
TECRS 4	5/8" x 3/8"	10B1	24 ÷ 44	M10	0,82
TECRS 5	3/4" x 7/16"	12B1	30 ÷ 60	M12	2,17

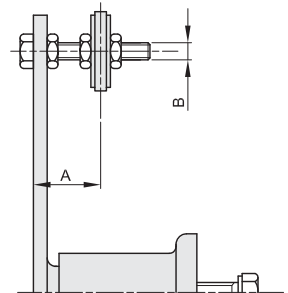

DOPPI

codice	catena	ISO	A	B	Kg.
TECRS 2	3/8" x 7/32"	06B2	25 ÷ 30	M 8	0,32
TECRS 3	1/2" x 5/16"	08B2	30 ÷ 34	M10	0,60
TECRS 4	5/8" x 3/8"	10B2	34 ÷ 46	M10	0,90
TECRS 5	3/4" x 7/16"	12B2	40 ÷ 52	M12	2,31

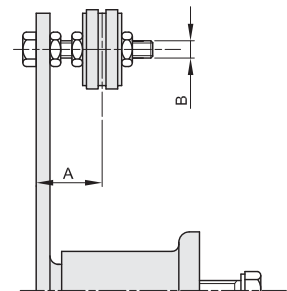

TENDICINGHIA UNIVERSALI TIPO "TERE"

UNIVERSAL BELT TENSIONERS TYPE "TERE"



codice	A	B	C	Ø D	E	Kg.
TERE 2	61	43	80	30	35	0,32
TERE 3	70	56	100	40	45	0,62
TERE 4	88	57	100	40	45	0,85
TERE 5	122	76	130	60	60	2,34
TERE 6	158	109	175	80	90	4,90
TERE 7	211	154	220	80	135	8,20

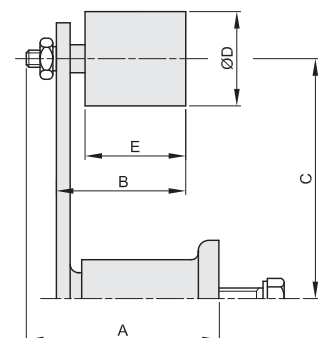

ELEMENTI TENDITORI UNIVERSALI TIPO "TE" UNIVERSAL TENSIONERS TYPE "TE"

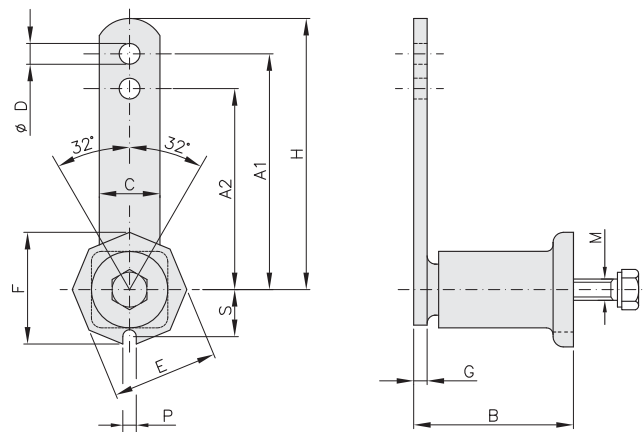

codice	A1	A2	B	C	Ø D	E	F	G	H	Forza max in N Torque in N ◁ 0 - 32°		M	P	S	Kg.
										A1	A2				
TE 2 *	80	60	52	20	8,5	35	38	5	90	0 - 90	0 - 110	M 6	8	16	0,25
TE 3 *	100	80	63	25	10,5	46	48	5	112,5	0 - 140	0 - 170	M 8	8,5	21	0,45
TE 4 *	100	80	78	30	10,5	56	59	6	115	0 - 320	0 - 430	M10	8,5	25	0,68
TE 5 *	130	100	108	50	12,5	72	76	8	155	0 - 820	0 - 1050	M12	10,5	32	1,95
TE 6	175	140	140	60	20,5	93	97	10	205	0 - 1500	0 - 1880	M16	12,5	41	3,70
TE 7 *	220	175	198	70	20,5	106	112	12	255	0 - 2500	0 - 3200	M20	12,5	51	6,50

* Disponibile anche in acciaio "INOX".

PIGNONI TENDICATENA TIPO "KS" - DIN 8187 SPROCKETS WHEELS TYPE "KS" - DIN 8187

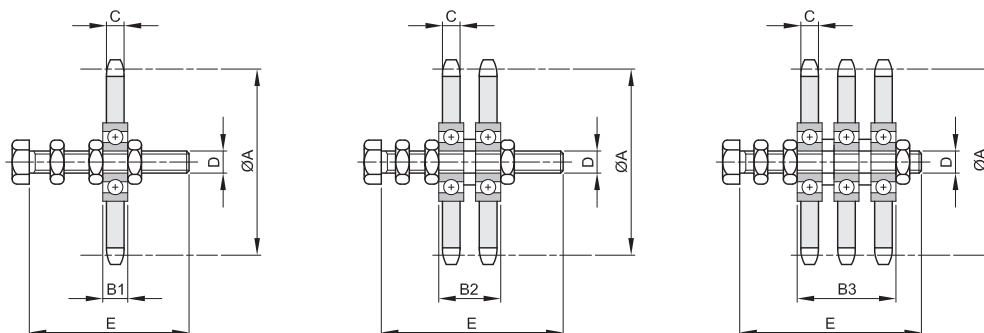

codice	ISO	denti	Ø A	B1	B2	B3	C	D	E	semplice Kg.	doppia Kg.	triplo Kg.
KS 3/8" x 7/32"	06B-1-2-3	15	45,81	9	19,2	29,4	5,7	M10	60	0,15	0,20	0,25
KS 1/2" x 5/16"	08B-1-2	15	61,08	9	22,9		7,2	M10	60	0,20	0,35	
KS 1/2" x 5/16"	08B-1-2-3	15	61,08	12	26,0	40,0	7,2	M12	80	0,23	0,45	0,50
KS 5/8" x 3/8"	10B-1-2-3	15	76,36	12	28,6	45,2	9,1	M12	80	0,37	0,60	0,95
KS 5/8" x 3/8"	10B-1-2-3	15	76,36	15	31,5	48,2	9,1	M20	120	0,70	1,00	1,25
KS 3/4" x 7/16"	12B-1-2	15	91,63	12	31,5		11,5	M12	80	0,60	1,05	
KS 3/4" x 7/16"	12B-1-2-3	15	91,63	15	34,5	54,0	11,5	M20	120	0,90	1,35	1,50
KS 1" x 17,02 mm	16B-1-2-3	13	106,14	15	46,9	78,8	16,2	M20	120	1,30	2,10	2,90
KS 1 1/4" x 3/4"	20B-1-2-3	13	132,67	15	51,5	88,0	18,5	M20	140	2,05	3,60	5,20
KS 1 1/2" x 1"	24B-1-2-3	11	135,23	15	63,4	111,8	24,1	M20	160	2,40	4,25	6,20

PATTINI TENDICATENA TIPO "CRS" CHAINRIDER SET TYPE "CRS"

RESATEC
CERTIFICATA ISO 9001

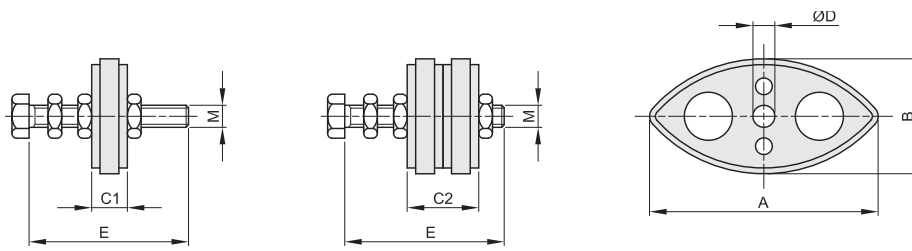

codice	catena	ISO	A	B	C1	C2	Ø D	M	E	semplice Kg.	doppio Kg.
CRS 3/8"	3/8" x 7/32"	06B	74	40	10,2	20,4	8	M 8	45	0,05	0,07
CRS 1/2"	1/2" x 5/16"	08B	96	50	13,9	27,8	10	M10	60	0,11	0,15
CRS 5/8"	5/8" x 3/8"	10B	125	55	16,5	33,0	10	M10	60	0,14	0,22
CRS 3/4"	3/4" x 7/16"	12B	147	80	19,5	39,0	12	M12	80	0,22	0,36

RULLI TENDICINGHIA TIPO "RE" ROLLERSET TYPE "RE"

RESATEC
CERTIFICATA ISO 9001

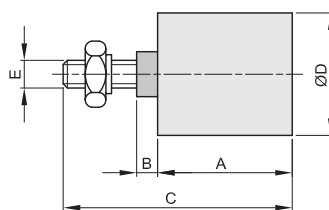

codice	A	B	C	Ø D	E	Kg.
RE 2	35	3	51	30	M 8	0,07
RE 3	45	6	67	40	M10	0,17
RE 4	45	6	67	40	M10	0,17
RE 5	60	7,5	89	60	M12	0,39
RE 6	90	9	127	80	M20	1,20
RE 7	135	7	167	80	M20	1,70

ELEMENTI OSCILLANTI TIPO "OM" OSCILLANTING MOUNTING TYPE "OM"

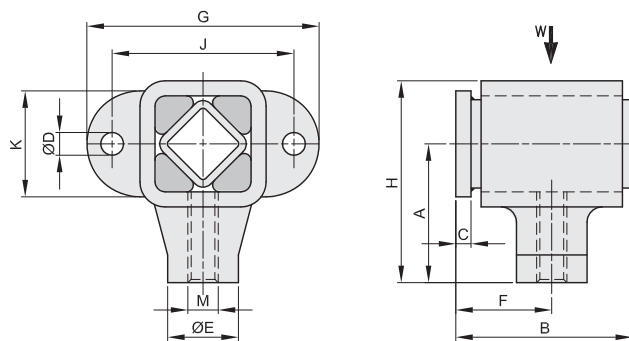

codice	A	B	C	Ø D	E	F	G	H	J	K	M	W carico max in N	Fr Freq. max in min ⁻¹	Kg.
OM 4 R	40	61	5	9	24	33	82	58	60	30	M12 R	190	1250	0,28
OM 4 L	40	61	5	9	24	33	82	58	60	30	M12 L	190	1250	0,28
OM 5 R	55	75	6	11	30	41	108	81	80	45	M16 R	380	780	0,58
OM 5 L	55	75	6	11	30	41	108	81	80	45	M16 L	380	780	0,58
OM 6 R	80	98	8	13	40	53	130	115	100	60	M20 R	780	760	1,45
OM 6 L	80	98	8	13	40	53	130	115	100	60	M20 L	780	760	1,45
OM 7 R	90	118	8	17	50	63	170	135	130	70	M24 R	1550	750	2,54
OM 7 L	90	118	8	17	50	63	170	135	130	70	M24 L	1550	750	2,54
OM 8 R	100	140	10	17	60	75	180	147	140	80	M36 R	2400	580	6,05
OM 8 L	100	140	10	17	60	75	180	147	140	80	M36 L	2400	580	6,05

TESTE DI BIELLA TIPO "DH" CRANKDRIVE UNIT TYPE "DH"

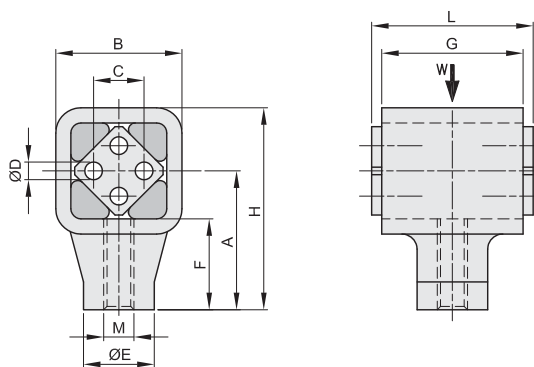

codice	A	B	C	Ø D	E	F	G	H	L	M	W forza accel. in N	ne Vel. di rotaz. in min ⁻¹	Kg.
DH 4-50 R	40	36	12	6	24	25	50	58	55	M12 R	380	1250	0,20
DH 4-50 L	40	36	12	6	24	25	50	58	55	M12 L	380	1250	0,20
DH 5-60 R	55	52	20	8	30	35	60	81	65	M16 R	960	1200	0,52
DH 5-60 L	55	52	20	8	30	35	60	81	65	M16 L	960	1200	0,52
DH 6-80 R	80	72	25	10	40	52	80	115	90	M20 R	1900	780	1,48
DH 6-80 L	80	72	25	10	40	52	80	115	90	M20 L	1900	780	1,48
DH 7-100 R	90	90	35	12	50	55	100	135	110	M24 R	3400	750	2,65
DH 7-100 L	90	90	35	12	50	55	100	135	110	M24 L	3400	750	2,65
DH 8-120 R	100	94	40	M12x30	60	64	120	147	130	M36 R	5800	580	6,30
DH 8-120 L	100	94	40	M12x30	60	64	120	147	130	M36 L	5800	580	6,30
DH 9-200 R	120	120	45	M16x25	80	75	200	180	210	M42 R	11500	330	17,70
DH 9-200 L	120	120	45	M16x25	80	75	200	180	210	M42 L	11500	330	17,70
DH 9-300 R	120	120	45	M16x25	80	75	300	180	310	M42 R	17500	300	26,50
DH 9-300 L	120	120	45	M16x25	80	75	300	180	310	M42 L	17500	300	26,50

ELEMENTI ELASTICI TIPO "LTK-S"

RUBBER SUSPENSION UNIT TYPE "LTK-S"

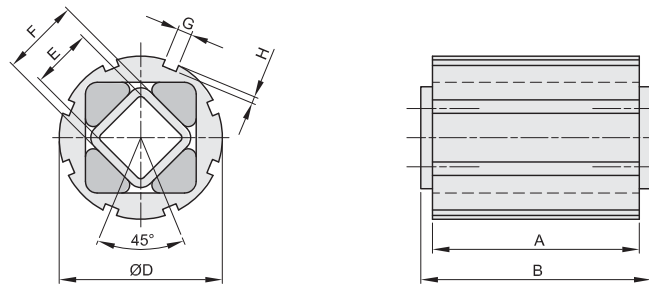

codice	COPPIA M IN NM A 32° TORQUE M IN NM AT 32°	A	B	Ø D	E	F	G	H	Kg.
LTK-S 5-40	56	40	45	62	22	27	6	3	0,30
LTK-S 5-60	85	60	65	62	22	27	6	3	0,40
LTK-S 5-100	140	100	105	62	22	27	6	3	0,65
LTK-S 6-60	160	60	70	80	30	38	7	3,5	0,70
LTK-S 6-80	215	80	90	80	30	38	7	3,5	0,90
LTK-S 6-120	320	120	130	80	30	38	7	3,5	1,30

ELEMENTI ELASTICI TIPO "LTK-A"

RUBBER SUSPENSION UNIT TYPE "LTK-A"

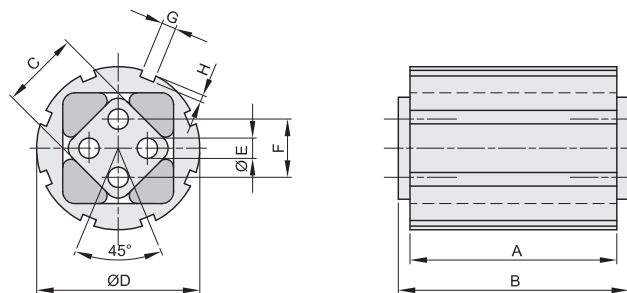

codice	COPPIA M IN NM A 32° TORQUE M IN NM AT 32°	A	B	C	Ø D	Ø E	F	G	H	Kg.
LTK-A 5-40	56	40	45	27	62	8	20	6	3	0,25
LTK-A 5-60	85	60	65	27	62	8	20	6	3	0,35
LTK-A 5-100	140	100	105	27	62	8	20	6	3	0,60
LTK-A 6-60	160	60	70	38	80	10	25	7	3,5	0,60
LTK-A 6-80	215	80	90	38	80	10	25	7	3,5	0,80
LTK-A 6-120	320	120	130	38	80	10	25	7	3,5	1,20

ELEMENTI ELASTICI TIPO "LTS"

RUBBER SUSPENSION UNIT TYPE "LTS"

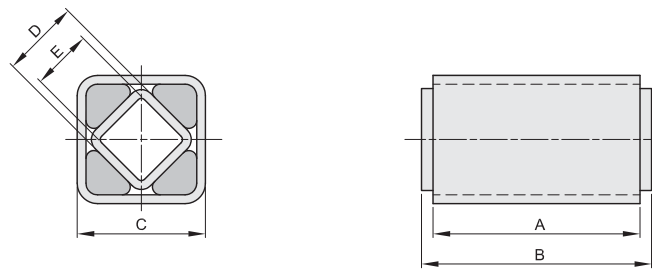

codice	COPPIA M IN NM A 32° TORQUE M IN NM AT 32°	A	B	C	D	E	Kg.
LTS 3-25	8	25	30	27	15	11	0,08
LTS 3-40	13	40	45	27	15	11	0,13
LTS 3-60	19	60	65	27	15	11	0,19
LTS 4-30	20	30	35	32	18	12	0,13
LTS 4-50	34	50	55	32	18	12	0,22
LTS 4-80	54	80	85	32	18	12	0,33
LTS 5-40	56	40	45	45	27	22	0,27
LTS 5-60	85	60	65	45	27	22	0,40
LTS 5-100	140	100	105	45	27	22	0,66
LTS 6-60	160	60	70	60	38	30	0,68
LTS 6-80	215	80	90	60	38	30	0,90
LTS 6-120	320	120	130	60	38	30	1,35
LTS 7-80	315	80	90	72	45	35	1,20
LTS 7-100	390	100	110	72	45	35	1,46
LTS 7-150	580	150	160	72	45	35	2,16
LTS 8-120	720	120	130	80	50	40	2,20
LTS 8-200	1300	200	210	80	50	40	3,50
LTS 8-300	2000	300	310	80	50	40	5,30

ELEMENTI ELASTICI TIPO "LTA"

RUBBER SUSPENSION UNIT TYPE "LTA"

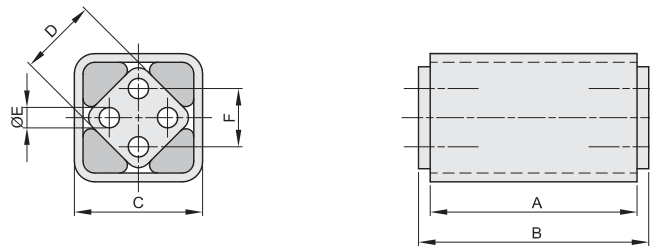

codice	COPPIA M IN NM A 32° TORQUE M IN NM AT 32°	A	B	C	D	Ø E	F	Kg.
LTA 4-30	20	30	35	32	18	6	12	0,10
LTA 4-50	34	50	55	32	18	6	12	0,15
LTA 4-80	54	80	85	32	18	6	12	0,26
LTA 5-40	56	40	45	45	27	8	20	0,26
LTA 5-60	85	60	65	45	27	8	20	0,37
LTA 5-100	140	100	105	45	27	8	20	0,62
LTA 6-60	160	60	70	60	38	10	25	0,61
LTA 6-80	215	80	90	60	38	10	25	0,80
LTA 6-120	320	120	130	60	38	10	25	1,15
LTA 7-80	315	80	90	72	45	12	35	1,01
LTA 7-100	390	100	110	72	45	12	35	3,00
LTA 7-150	580	150	160	72	45	12	35	4,45
LTA 8-120	760	120	130	80	50	M12x40	40	1,85
LTA 8-200	1370	200	210	80	50	M12x40	40	3,02
LTA 8-300	2050	300	310	80	50	M12x40	40	4,48

ELEMENTI OSCILLANTI TIPO "HC"

OSCILLANTING-MOUNTINGS TYPE "HC"

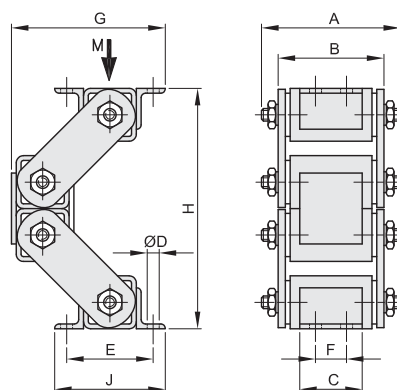

codice	A	B	C	Ø D	E	F	G	G max	H	H min	J	CARICO LAOD M in N	Kg.
HC 6	138	117	65	13	100	40	180	205	290	190	120	500 - 1500	6,90
HC 7	168	142	80	13	115	48	201	225	335	235	135	1100 - 3200	13,50
HC 8	195	164	100	17	130	60	224	260	360	250	160	2400 - 7000	20,50

SUPPORTI TIPO "MA" MOUNTING SUPPORT TYPE "MA"

RESATEC
CERTIFICATA ISO 9001

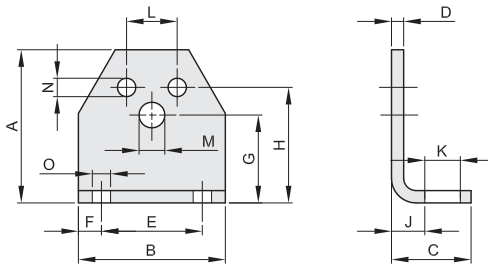

codice	adatto a tipo		A	B	C	D	E	F	G	H	J	K	L	M	N	O	Kg.
	TE...	LT...															
MA 2	2	3	46	50	30	4	30	10	27	35	12	13	10	6,5	5,5	7	0,09
MA 3	3	4	58	60	32	6	40	10	34	44	14	13	12	8,5	6,5	7	0,19
MA 4	4	5	75	70	38	6	50	10	45	55	16	16	20	10,5	8,5	9,5	0,30
MA 5	5	6	98	90	52	8	65	12,5	58	75	21	22	25	12,5	10,5	11,5	0,70
MA 6	6	7	116	110	55	8	80	15	66	85	21	24	35	16,5	12,5	14	0,90
MA 7	7	8	140	140	66	10	100	20	80	110	26	30	40	20,5	12,5	18	1,80

STAFFE TIPO "CK" MOUNTING CLAMP TYPE "CK"

RESATEC
CERTIFICATA ISO 9001

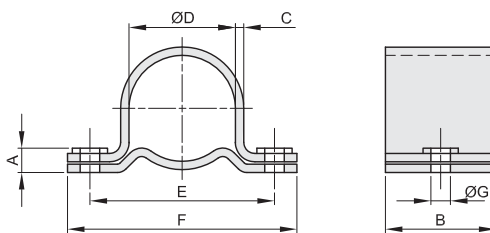

codice	A	B	C	ØD	E	F	ØG	Kg.
CK 5	10	40	3	62	92	125	10,5	0,30
CK 6	11	40	3	80	115	150	12,5	0,45

STAFFE TIPO "MS" MOUNTING CLAMP TYPE "MS"

RESATEC
CERTIFICATA ISO 9001

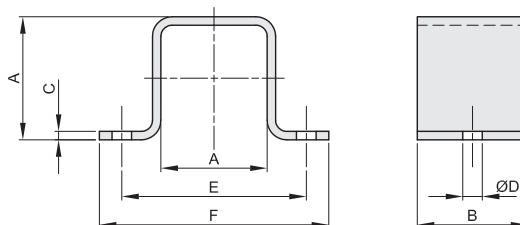

codice	A	B	C	ØD	E	F	Kg.
MS 3	27	25	2	6,5	50	65	0,04
MS 4	32	30	3	8,5	60	80	0,09
MS 5	45	35	3	10,5	80	105	0,16
MS 6	60	40	5	12,5	100	125	0,29
MS 7	72	45	5	12,5	115	145	0,45
MS 8	80	50	6	17	130	170	0,68

RUOTE DENTATE CILINDRICHE CYLINDRICAL GEARS

MODULO 1
ANGOLO DI PRESSIONE 20°

A	B
25	15

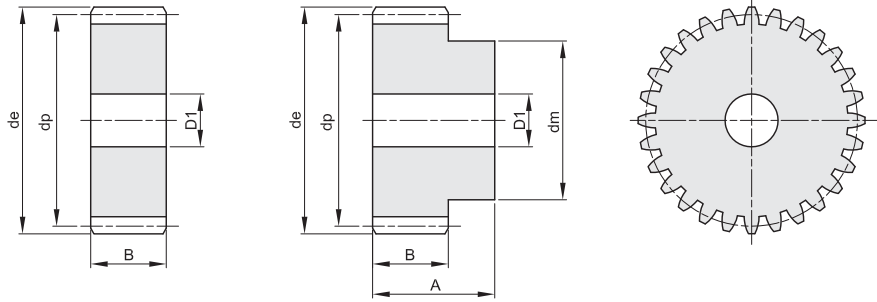

Materiale acciaio C45

Z	de	dp	dm	D1	Kg.	Z	de	dp	dm	D1	Kg.
12	14	12	9	-	0,01	55	57	55	40	12	0,36
13	15	13	10	-	0,02	56	58	56	40	12	0,37
14	16	14	11	-	0,02	57	59	57	40	12	0,38
15	17	15	12	-	0,02	58	60	58	40	12	0,39
16	18	16	13	-	0,03	59	61	59	40	12	0,40
17	19	17	14	-	0,03	60	62	60	40	12	0,41
18	20	18	15	8	0,03	61	63	61	50	12	0,47
19	21	19	15	8	0,04	62	64	62	50	12	0,49
20	22	20	16	8	0,04	63	65	63	50	12	0,50
21	23	21	16	8	0,05	64	66	64	50	12	0,51
22	24	22	16	8	0,05	65	67	65	50	12	0,52
23	25	23	18	8	0,06	66	68	66	50	12	0,53
24	26	24	20	10	0,06	67	69	67	50	12	0,55
25	27	25	20	10	0,07	68	70	68	50	12	0,56
26	28	26	20	10	0,07	69	71	69	50	12	0,57
27	29	27	20	10	0,08	70	72	70	50	12	0,58
28	30	28	20	10	0,08	72	74	72		12	0,46
29	31	29	20	10	0,09	75	77	75		12	0,51
30	32	30	20	10	0,09	76	78	76		12	0,52
31	33	31	25	10	0,11	80	82	80		12	0,58
32	34	32	25	10	0,12	85	87	85		12	0,65
33	35	33	25	10	0,12	90	92	90		12	0,73
34	36	34	25	10	0,13	95	97	95		12	0,82
35	37	35	25	10	0,14	100	102	100		12	0,91
36	38	36	25	10	0,14	110	112	110		12	1,10
37	39	37	25	10	0,15	114	116	114		12	1,19
38	40	38	25	10	0,16	120	122	120		12	1,32
39	41	39	25	10	0,16	127	129	127		12	1,47
40	42	40	25	10	0,17						
41	43	41	30	10	0,19						
42	44	42	30	10	0,20						
43	45	43	30	10	0,21						
44	46	44	30	10	0,22						
45	47	45	30	10	0,23						
46	48	46	30	10	0,23						
47	49	47	30	10	0,24						
48	50	48	30	10	0,25						
49	51	49	30	10	0,26						
50	52	50	30	12	0,26						
51	53	51	40	12	0,32						
52	54	52	40	12	0,33						
53	55	53	40	12	0,33						
54	56	54	40	12	0,34						

RUOTE DENTATE CILINDRICHE CYLINDRICAL GEARS

MODULO 1,5
ANGOLO DI PRESSIONE 20°

A	B
30	17

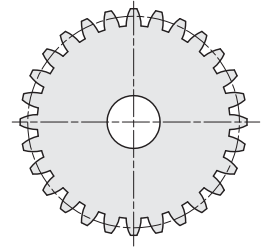
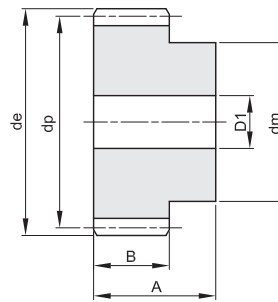
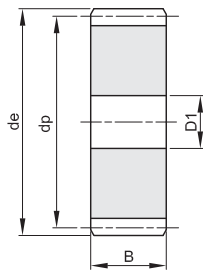

Materiale acciaio C45

Z	d_e	d_p	d_m	D1	Kg.
12	21,0	18,0	14	8	0,04
13	22,5	19,5	15	8	0,05
14	24,0	21,0	17	8	0,06
15	25,5	22,5	18	8	0,07
16	27,0	24,0	19	8	0,08
17	28,5	25,5	20	8	0,09
18	30,0	27,0	20	8	0,10
19	31,5	28,5	20	8	0,10
20	33,0	30,0	25	8	0,13
21	34,5	31,5	25	10	0,13
22	36,0	33,0	25	10	0,14
23	37,5	34,5	25	10	0,16
24	39,0	36,0	25	10	0,17
25	40,5	37,5	25	10	0,18
26	42,0	39,0	30	12	0,20
27	43,5	40,5	30	12	0,22
28	45,0	42,0	30	12	0,23
29	46,5	43,5	30	12	0,24
30	48,0	45,0	30	12	0,26
31	49,5	46,5	35	12	0,30
32	51,0	48,0	35	12	0,31
33	52,5	49,5	35	12	0,33
34	54,0	51,0	35	12	0,34
35	55,5	52,5	35	12	0,36
36	57,0	54,0	35	12	0,37
37	58,5	55,5	40	12	0,42
38	60,0	57,0	40	12	0,44
39	61,5	58,5	40	12	0,46
40	63,0	60,0	40	12	0,48
41	64,5	61,5	40	12	0,50
42	66,0	63,0	50	12	0,59
43	67,5	64,5	50	12	0,61
44	69,0	66,0	50	12	0,63
45	70,5	67,5	50	12	0,65
46	72,0	69,0	50	14	0,66
47	73,5	70,5	50	14	0,70
48	75,0	72,0	50	14	0,70
49	76,5	73,5	50	14	0,73
50	78,0	75,0	50	14	0,76
51	79,5	76,5	60	14	0,86
52	81,0	78,0	60	14	0,89
53	82,5	79,5	60	14	0,91
54	84,0	81,0	60	14	0,94

Z	d_e	d_p	d_m	D1	Kg.
55	85,5	82,5	60	14	0,96
56	87,0	84,0	60	16	0,98
57	88,5	85,5	60	16	1,00
58	90,0	87,0	60	16	1,03
59	91,5	88,5	60	16	1,06
60	93,0	90,0	60	16	1,09
61	94,5	91,5	70	16	1,22
62	96,0	93,0	70	16	1,25
63	97,5	94,5	70	16	1,28
64	99,0	96,0	70	16	1,31
65	100,5	97,5	70	16	1,34
66	102,0	99,0	70	16	1,37
67	103,5	100,5	70	16	1,40
68	105,0	102,0	70	16	1,43
69	106,5	103,5	70	16	1,46
70	108,0	105,0	70	16	1,50
72	111,0	108,0		16	1,19
75	115,5	112,5		16	1,30
76	117,0	114,0		16	1,33
80	123,0	120,0		16	1,48
85	130,5	127,5		16	1,67
90	138,0	135,0		16	1,88
95	145,5	142,5		16	2,09
100	153,0	150,0		16	2,32
110	168,0	165,0		16	2,82
114	174,0	171,0		16	3,03
120	183,0	180,0		16	3,36
127	193,5	190,5		16	3,77

RUOTE DENTATE CILINDRICHE CYLINDRICAL GEARS

MODULO 2
ANGOLO DI PRESSIONE 20°

A	B
35	20

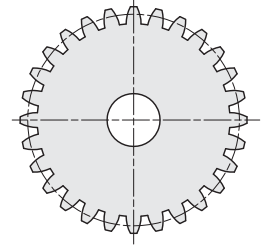
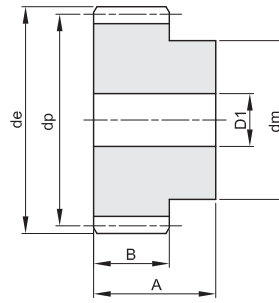
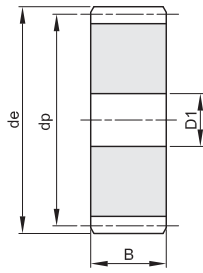

Materiale acciaio C45

Z	d_e	d_p	d_m	D_1	Kg.	Z	d_e	d_p	d_m	D_1	Kg.
12	28	24	18	10	0,08	55	114	110	70	16	1,88
13	30	26	20	10	0,10	56	116	112	70	16	1,94
14	32	28	22	10	0,12	57	118	114	70	16	1,99
15	34	30	24	10	0,14	58	120	116	70	16	2,05
16	36	32	25	10	0,16	59	122	118	70	16	2,11
17	38	34	25	10	0,18	60	124	120	70	16	2,16
18	40	36	25	10	0,19	61	126	122	80	16	2,36
19	42	38	25	10	0,21	62	128	124	80	16	2,42
20	44	40	30	10	0,26	63	130	126	80	16	2,48
21	46	42	30	12	0,27	64	132	128	80	16	2,55
22	48	44	30	12	0,29	65	134	130	80	16	2,61
23	50	46	30	12	0,31	66	136	132	80	16	2,67
24	52	48	35	12	0,36	67	138	134	80	16	2,74
25	54	50	35	12	0,39	68	140	136	80	16	2,81
26	56	52	40	12	0,45	69	142	138	80	16	2,87
27	58	54	40	12	0,47	70	144	140	80	16	2,94
28	60	56	40	12	0,50	72	148	144		16	2,50
29	62	58	40	14	0,52	75	154	150		20	2,71
30	64	60	40	14	0,55	76	156	152		20	2,79
31	66	62	45	14	0,61	80	164	160		20	3,09
32	68	64	45	14	0,65	85	174	170		20	3,50
33	70	66	45	14	0,68	90	184	180		20	3,93
34	72	68	45	14	0,71	95	194	190		20	4,39
35	74	70	45	14	0,74	100	204	200		20	4,87
36	76	72	45	14	0,78	110	224	220		20	5,90
37	78	74	50	14	0,86	114	232	228		20	6,34
38	80	76	50	14	0,90	120	244	240		20	7,03
39	82	78	50	14	0,93	127	258	254		20	7,89
40	84	80	50	14	0,97						
41	86	82	55	16	1,05						
42	88	84	55	16	1,09						
43	90	86	55	16	1,13						
44	92	88	60	16	1,23						
45	94	90	60	16	1,27						
46	96	92	60	16	1,31						
47	98	94	70	16	1,48						
48	100	96	70	16	1,53						
49	102	98	70	16	1,57						
50	104	100	70	16	1,62						
51	106	102	70	16	1,67						
52	108	104	70	16	1,72						
53	110	106	70	16	1,78						
54	112	108	70	16	1,83						

RUOTE DENTATE CILINDRICHE CYLINDRICAL GEARS

MODULO 2,5
ANGOLO DI PRESSIONE 20°

A	B
45	25

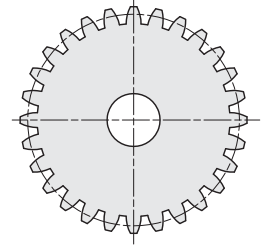
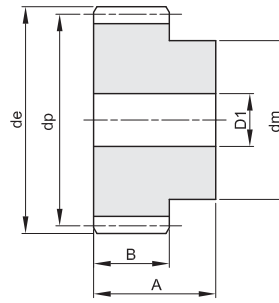
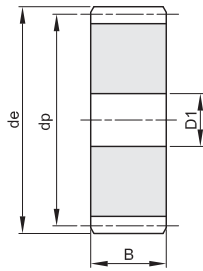

Materiale acciaio C45

Z	d_e	d_p	d_m	D_1	Kg.
12	35,0	30,0	22	10	0,17
13	37,5	32,5	25	10	0,21
14	40,0	35,0	28	10	0,25
15	42,5	37,5	30	10	0,30
16	45,0	40,0	32	12	0,33
17	47,5	42,5	35	12	0,38
18	50,0	45,0	35	12	0,42
19	52,5	47,5	35	12	0,45
20	55,0	50,0	40	12	0,54
21	57,5	52,5	40	14	0,56
22	60,0	55,0	45	14	0,66
23	62,5	57,5	45	14	0,70
24	65,0	60,0	45	14	0,74
25	67,5	62,5	50	14	0,85
26	70,0	65,0	50	14	0,90
27	72,5	67,5	50	14	0,95
28	75,0	70,0	50	14	1,00
29	77,5	72,5	50	14	1,06
30	80,0	75,0	55	14	1,18
31	82,5	77,5	55	16	1,22
32	85,0	80,0	55	16	1,28
33	87,5	82,5	55	16	1,34
34	90,0	85,0	55	16	1,41
35	92,5	87,5	60	16	1,54
36	95,0	90,0	60	16	1,61
37	97,5	92,5	60	16	1,68
38	100,0	95,0	60	16	1,75
39	102,5	97,5	60	16	1,83
40	105,0	100,0	70	16	2,06
41	107,5	102,5	70	16	2,14
42	110,0	105,0	70	16	2,22
43	112,5	107,5	70	16	2,30
44	115,0	110,0	70	16	2,38
45	117,5	112,5	70	16	2,47
46	120,0	115,0	70	20	2,52
47	122,5	117,5	80	20	2,80
48	125,0	120,0	80	20	2,88
49	127,5	122,5	80	20	2,98
50	130,0	125,0	80	20	3,07
51	132,5	127,5	80	20	3,17
52	135,0	130,0	90	20	3,48
53	137,5	132,5	90	20	3,58
54	140,0	135,0	90	20	3,68

Z	d_e	d_p	d_m	D_1	Kg.
55	142,5	137,5	90	20	3,78
56	145,0	140,0	100	20	4,13
57	147,5	142,5	100	20	4,23
58	150,0	145,0	100	20	4,34
59	152,5	147,5	100	20	4,46
60	155,0	150,0	100	20	4,57
65	167,5	162,5		20	3,99
70	180,0	175,0		20	4,64
72	185,0	180,0		20	4,91
75	192,5	187,5		20	5,33
76	195,0	190,0		20	5,48
80	205,0	200,0		25	6,04
85	217,5	212,5		25	6,84
90	230,0	225,0		25	7,68
95	242,5	237,5		25	8,57
100	255,0	250,0		25	9,51
110	280,0	275,0		25	11,53
114	290,0	285,0		25	12,39
120	305,0	300,0		25	13,74
127	322,5	317,5		25	15,40

RUOTE DENTATE CILINDRICHE CYLINDRICAL GEARS

MODULO 3

ANGOLO DI PRESSIONE 20°

A

B

50

30

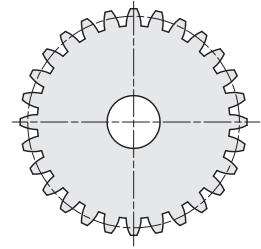
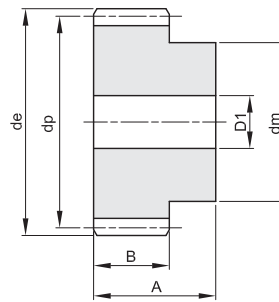
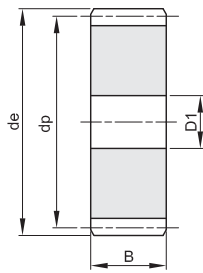

Materiale acciaio C45

Z	d_e	d_p	d_m	D_1	Kg.	Z	d_e	d_p	d_m	D_1	Kg.
12	42	36	27	12	0,28	70	216	210	25	8,00	
13	45	39	30	12	0,34	72	222	216	25	8,47	
14	48	42	33	12	0,41	75	231	225	25	9,21	
15	51	45	35	12	0,47	76	234	228	25	9,46	
16	54	48	38	14	0,54	80	246	240	25	10,49	
17	57	51	42	14	0,63	85	261	255	25	11,86	
18	60	54	45	14	0,72	90	276	270	25	13,32	
19	63	57	45	14	0,78	95	291	285	25	14,86	
20	66	60	45	14	0,84	100	306	300	25	16,48	
21	69	63	45	16	0,89	110	336	320	25	19,97	
22	72	66	50	16	1,02	114	348	342	30	21,40	
23	75	69	50	16	1,10	120	366	360	30	23,74	
24	78	72	50	16	1,18	127	387	381	30	26,61	
25	81	75	60	16	1,39						
26	84	78	60	16	1,48						
27	87	81	60	16	1,56						
28	90	84	60	16	1,66						
29	93	87	60	16	1,75						
30	96	90	60	16	1,85						
31	99	93	60	16	1,95						
32	102	96	70	16	2,21						
33	105	99	70	16	2,32						
34	108	102	70	16	2,43						
35	111	105	70	16	2,55						
36	114	108	70	20	2,62						
37	117	111	70	20	2,74						
38	120	114	80	20	3,05						
39	123	117	80	20	3,18						
40	126	120	80	20	3,31						
41	129	123	80	20	3,44						
42	132	126	80	20	3,58						
43	135	129	80	20	3,72						
44	138	132	90	20	4,07						
45	141	135	90	20	4,22						
46	144	138	90	20	4,37						
47	147	141	100	20	4,76						
48	150	144	100	20	4,92						
50	156	150		20	4,06						
52	162	156		20	4,40						
55	171	165		20	4,93						
57	177	171		20	5,30						
60	186	180		20	5,89						
65	201	195		20	6,92						

RUOTE DENTATE CILINDRICHE CYLINDRICAL GEARS

MODULO 4
ANGOLO DI PRESSIONE **20°**

A	B
60	40

Materiale acciaio C45

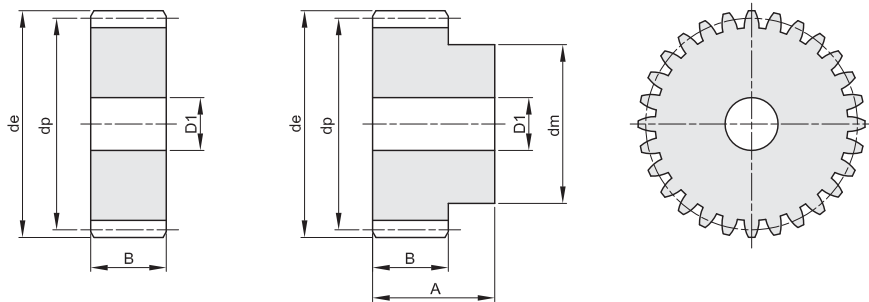

Z	de	dp	dm	D1	Kg.
12	56	48	35	14	0,63
13	60	52	40	14	0,78
14	64	56	45	14	0,93
15	68	60	45	14	1,05
16	72	64	50	16	1,20
17	76	68	50	16	1,33
18	80	72	50	16	1,47
19	84	76	60	16	1,75
20	88	80	60	16	1,90
21	92	84	70	16	2,22
22	96	88	70	16	2,39
23	100	92	75	20	2,60
24	104	96	75	20	2,79
25	108	100	75	20	2,98
26	112	104	75	20	3,18
27	116	108	75	20	3,39
28	120	112	75	20	3,60
29	124	116	75	20	3,83
30	128	120	75	20	4,06
31	132	124	80	20	4,39
32	136	128	80	20	4,64
33	140	132	80	20	4,90
34	144	136	80	20	5,16
35	148	140	80	20	5,43
36	152	144	80	25	5,63
38	160	152		25	5,20
40	168	160		25	6,11
45	188	180		25	7,78
48	200	192		25	8,87
50	208	200		25	9,65
52	216	208		25	10,45
55	228	220		25	11,71
57	236	228		25	12,59
60	248	240		25	13,97
65	268	260		25	16,43
70	288	280		25	19,09
75	308	300		25	21,94
76	312	304		30	22,47
80	328	320		30	24,93
85	348	340		30	28,18
90	368	360		30	31,62
95	388	380		30	35,26
100	408	400		30	39,11

Z	de	dp	dm	D1	Kg.
110	448	440		30	47,38
114	464	456		30	50,91

RUOTE DENTATE CILINDRICHE CYLINDRICAL GEARS

MODULO 5

ANGOLO DI PRESSIONE 20°

A

B

75

50

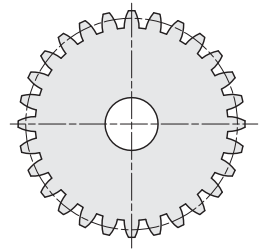
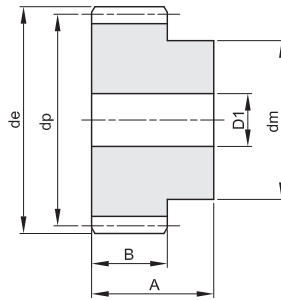
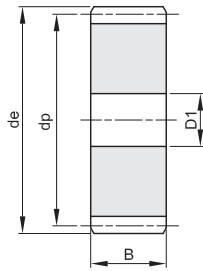

Materiale acciaio C45

Z	de	dp	dm	D1	Kg.	Z	de	dp	dm	D1	Kg.
12	70	60	45	20	1,21						
13	75	65	50	20	1,47						
14	80	70	55	20	1,76						
15	85	75	60	20	2,07						
16	90	80	65	20	2,40						
17	95	85	70	20	2,75						
18	100	90	70	20	3,02						
19	105	95	70	20	3,30						
20	110	100	80	20	3,83						
21	115	105	80	20	4,15						
22	120	110	80	20	4,48						
23	125	115	90	20	5,08						
24	130	120	90	20	5,44						
25	135	125	90	20	5,82						
26	140	130	100	20	6,50						
27	145	135	100	20	6,91						
28	150	140	100	25	7,22						
29	155	145	110	25	7,98						
30	160	150	110	25	8,44						
32	170	160		25	7,62						
35	185	175		25	9,16						
38	200	190		25	10,84						
40	210	200		25	12,04						
45	235	225		25	15,30						
48	250	240		25	17,44						
50	260	250		30	18,86						
52	270	260		30	20,43						
55	285	275		30	22,89						
57	295	285		30	24,62						
60	310	300		30	27,31						
65	335	325		30	32,12						
70	360	350		30	37,31						
75	385	375		30	42,88						
76	390	380		30	44,04						
80	410	400		30	48,84						
85	435	425		30	55,19						
90	460	450		30	61,92						
95	485	475		30	69,03						
100	510	500		30	76,53						
110	560	550		30	92,69						
114	580	570		30	99,59						

RUOTE DENTATE CILINDRICHE CYLINDRICAL GEARS

MODULO 6

ANGOLO DI PRESSIONE 20°

A	B
80	60

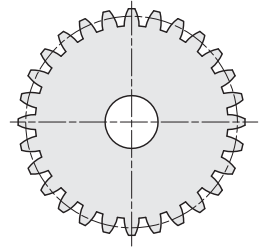
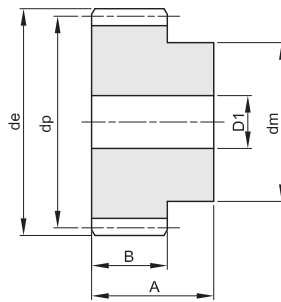
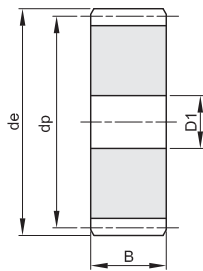

Materiale acciaio C45

Z	de	dp	dm	D1	Kg.
12	84	72	54	20	1,98
13	90	78	60	20	2,38
15	102	90	70	20	3,29
16	108	95	75	20	3,80
18	120	108	80	20	4,76
20	132	120	90	20	5,99
24	156	144	110	25	8,70
25	162	150	110	25	9,33
28	180	168		25	10,00
30	192	180		25	11,55
32	204	192		25	13,22
35	222	210		25	15,79
38	240	228		25	18,74
40	252	240		25	20,75

Z	de	dp	dm	D1	Kg.

CREMAGLIERE INTESTATE PER IL MONTAGGIO CONTINUO - ANGOLO DI PRESSIONE 20°

RACKS-CONTINUOUS MOUNTING - PRESSURE ANGLE 20°

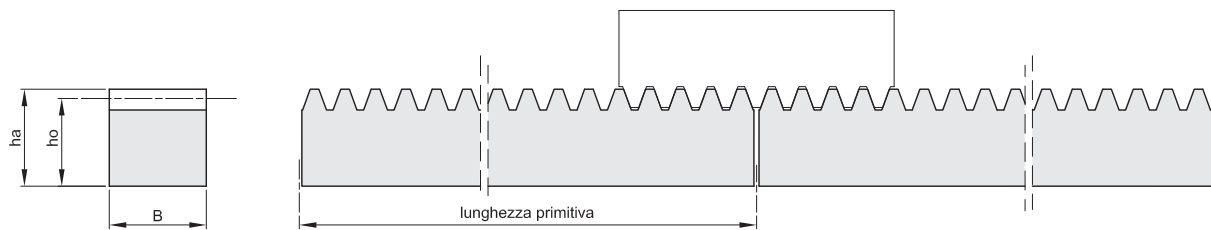

Materiale acciaio C45

modulo x lunghezza	lunghezza primitiva	denti	B x ha	ho	Kg.
1 x 500	499,51	159	15 x 15	14	0,80
1 x 1000	1002,17	319	15 x 15	14	1,60
1 x 2000	2001,19	637	15 x 15	14	3,30
1,5 x 500	499,51	106	17 x 17	15,5	1,00
1,5 x 1000	1003,74	213	17 x 17	15,5	2,10
1,5 x 2000	2002,77	425	17 x 17	15,5	4,10
2 x 500	502,65	80	20 x 20	18	1,40
2 x 1000	1005,31	160	20 x 20	18	2,80
2 x 2000	2004,34	319	20 x 20	18	5,60
2,5 x 500	502,65	64	25 x 25	22,5	2,20
2,5 x 1000	1005,31	128	25 x 25	22,5	4,40
2,5 x 2000	2002,77	255	25 x 25	22,5	8,70
3 x 500	499,51	53	30 x 30	27	3,20
3 x 1000	1008,45	107	30 x 30	27	6,30
3 x 2000	2007,48	213	30 x 30	27	12,60
4 x 1000	1005,31	80	30 x 30	26	6,00
4 x 2000	2010,62	160	30 x 30	26	12,10
4 x 500	502,65	40	40 x 40	36	5,60
4 x 1000	1005,31	80	40 x 40	36	11,20
4 x 2000	2010,62	160	40 x 40	36	22,40
5 x 500	502,65	32	50 x 50	45	8,70
5 x 1000	1005,31	64	50 x 50	45	17,50
5 x 2000	2010,62	128	50 x 50	45	35,00
6 x 1000	1017,88	54	60 x 60	54	25,20
6 x 2000	2016,90	107	60 x 60	54	50,40

RUOTE DENTATE CONICHE DENTI DIRITTI TIPO "A"

CONICAL STRAIGHT TOOTHED GEARS TYPE "A"

RAPPORTO 1:1
 ANGOLO DI PRESSIONE **20°**
 ANGOLO FRA GLI ALBERI $\Sigma = 90^\circ$

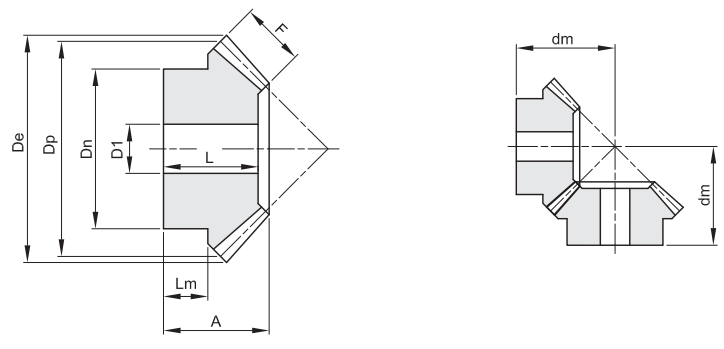

Materiale acciaio C45

modulo	denti	De	Dp	A	F	Dn	D1	dm	L	Lm	Kg.
1,5	16	26,1	24,0	18	8	18	8	23,8	17	8,9	0,03
1,5	20	32,1	30,0	20	8	22	10	28,7	18	9,8	0,05
1,5	22	35,1	33,0	20	8	25	10	30,2	18	9,7	0,07
1,5	25	39,6	37,5	23	8	28	10	35,4	21	12	0,10
1,5	30	47,1	45,0	25	10	30	12	39,7	22,5	12	0,15
2	16	34,8	32,0	20	9	25	10	28,8	17	9,3	0,06
2	20	42,8	40,0	25	12	32	10	35,7	22	12	0,14
2	22	46,8	44,0	25	12	36	10	37,7	22	11,7	0,18
2	25	52,8	50,0	28	14	40	12	42,3	25	12,3	0,25
2	30	62,8	60,0	30	16	50	12	47,8	27	12,8	0,41
2,5	16	43,5	40,0	25,5	10	32	12	37,3	22	13,3	0,13
2,5	20	53,5	50,0	30,5	12	40	12	45,9	27	16	0,27
2,5	22	58,5	55,0	30,5	12	45	12	48,3	27	15,9	0,34
2,5	25	66,0	62,5	33,5	15	50	15	53,0	30	16	0,47
2,5	30	78,5	75,0	35,5	18	55	15	59,1	32	16	0,69
3	16	52,2	48,0	30	12	40	15	44,2	26	16,2	0,24
3	20	64,2	60,0	35	18	45	15	51,1	31	13,6	0,41
3	22	70,2	66,0	35	18	50	15	54,0	31	13	0,52
3	25	79,2	75,0	38	20	55	15	60,0	34	16	0,72
3	30	94,2	90,0	40	22	60	20	68,1	36	19	0,99
3,5	16	60,9	56,0	35,5	16	45	15	50,8	31	17,2	0,38
3,5	20	74,9	70,0	40,5	22	55	15	58,6	36	19	0,68
3,5	22	81,9	77,0	40,5	22	60	15	62,0	36	18	0,84
3,5	25	92,4	87,5	43,5	26	65	20	67,5	39	18	1,10
3,5	30	109,9	105,0	45,5	30	70	20	75,4	41	17	1,61
4	16	69,6	64,0	38	18	50	15	55,6	33	16,6	0,52
4	20	85,6	80,0	43	25	60	18	63,8	38	18	0,90
4	22	93,6	88,0	43	25	65	18	67,7	38	18	1,11
4	25	105,6	100,0	45	28	70	20	73,5	40	18	1,45
4	30	125,6	120,0	48	32	80	25	83,7	43	16	2,66
4,5	16	78,3	72,0	43	20	55	18	63,0	37	18,5	0,73
4,5	20	96,3	90,0	48	28	65	20	71,5	42	18	1,25
4,5	22	105,3	99,0	48	28	70	20	75,8	42	18	1,55
4,5	25	118,8	112,5	50	32	75	20	81,8	44	18	2,04
4,5	30	141,3	135,0	53	35	90	25	93,8	47	17	3,24
5	16	87,0	80,0	45,5	22	60	20	67,8	39	17,8	0,94
5	20	107,1	100,0	50,5	30	70	20	77,3	44	18,5	1,61
5	22	117,1	110,0	50,5	30	80	20	82,2	44	18,5	2,08
5	25	132,1	125,0	54,5	35	90	20	90,2	48	18,5	2,94
5	30	157,1	150,0	56,5	38	110	30	102,4	50	18	4,46

RUOTE DENTATE CONICHE DENTI DIRITTI TIPO "A" CONICAL STRAIGHT TOOTHED GEARS TYPE "A"

RAPPORTO 1:2

ANGOLO DI PRESSIONE 20°

ANGOLO FRA GLI ALBERI $\Sigma = 90^\circ$

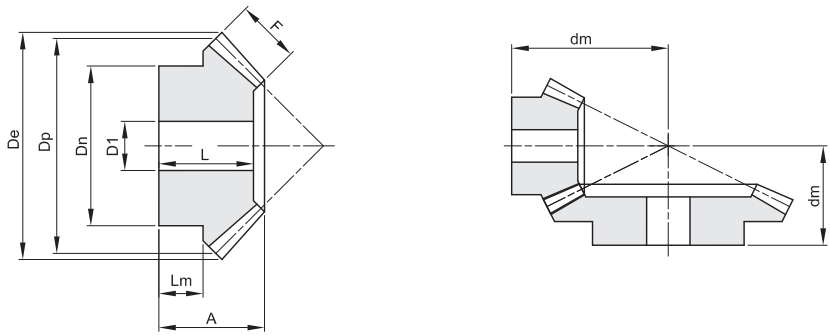

Materiale acciaio C45

modulo	denti	De	Dp	A	F	Dn	D1	dm	L	Lm	Kg.
1,5	16	26,7	24	18,5	8	21	10	34,9	17	10,3	0,04
1,5	32	49,3	48	20	8	32	12	27,5	17,5	10	0,14
2	16	35,6	32	23	10	27	10	45,4	21	12,2	0,09
2	32	65,8	64	25	10	40	12	35,2	22	10	0,14
2,5	16	44,4	40	27,5	12	34	12	56,0	25	14,4	0,16
2,5	32	82,2	80	30	12	50	15	43,0	26,5	15	0,59
3	16	53,4	48	28	15	40	15	61,6	25	11,6	0,23
3	32	98,7	96	35	15	60	15	50,4	30,5	15	1,05
3,5	16	62,3	56	33,5	18	48	15	72,3	30,5	14,4	0,40
3,5	32	115,1	112	40	18	70	20	57,7	35	19	1,57
4	16	71,1	64	36	20	50	20	80,8	32	13,4	0,49
4	32	131,6	128	45	20	80	20	65,5	39,5	23	2,29
4,5	16	80,1	72	39,5	22	60	20	90,4	35	15,4	0,75
4,5	32	148,0	144	50	22	80	25	73,2	43,5	24	2,99
5	16	88,9	80	50	25	60	20	106,1	45	21,1	1,07
5	32	164,5	160	55	25	85	25	80,6	48	27	3,95

RAPPORTO 1:3

ANGOLO DI PRESSIONE 20°

ANGOLO FRA GLI ALBERI $\Sigma = 90^\circ$

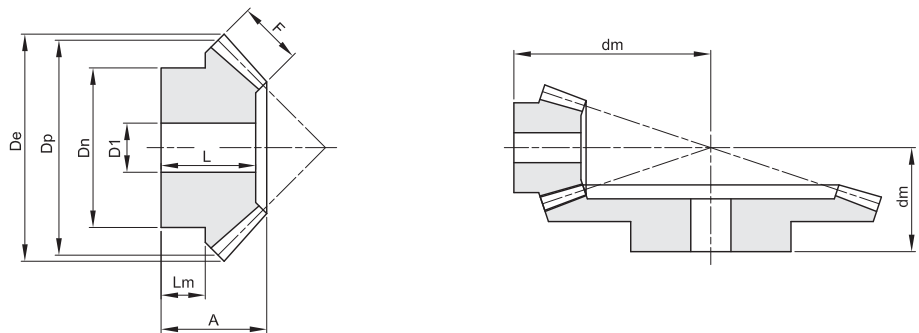

Materiale acciaio C45

modulo	denti	De	Dp	A	F	Dn	D1	dm	L	Lm	Kg.
1,5	16	26,9	24	22	12	20	10	46,3	21	9,7	0,04
1,5	48	72,9	72	22	12	42	15	29,2	19	12	0,31
2	16	35,8	32	25,5	15	25	12	58,9	24	9,4	0,08
2	48	97,3	96	26	15	50	15	35,9	22	13	0,67
2,5	16	44,7	40	28	18	33	14	70,4	26	9,2	0,15
2,5	48	121,6	120	32	18	60	20	44,6	27	16	1,22
3	16	53,7	48	30	18	42	15	84,2	28	11,2	0,27
3	48	145,9	144	38	18	65	20	54,1	32	19	2,01
3,5	16	62,6	56	36,5	22	48	15	98,8	34	13,4	0,45
3,5	48	170,2	168	44	22	75	20	62,5	37	23	3,08
4	16	71,6	64	42	25	55	20	113,3	39	15,7	0,67
4	48	194,5	192	50	25	85	22	71,2	42	27	4,40
4,5	16	80,6	72	53	28	60	20	133,4	50	23,4	1,05
4,5	48	218,8	216	58	28	90	25	81,9	49	27	7,23
5	16	89,5	80	60	35	60	20	145,7	57	22,5	1,38
5	48	243,1	240	65	35	100	28	90,5	55	35	8,72

RUOTE DENTATE CONICHE DENTI DIRITTI TIPO "A"

CONICAL STRAIGHT TOOTHED GEARS TYPE "A"

RAPPORTO 1:4
 ANGOLO DI PRESSIONE 20°
 ANGOLO FRA GLI ALBERI $\Sigma = 90^\circ$

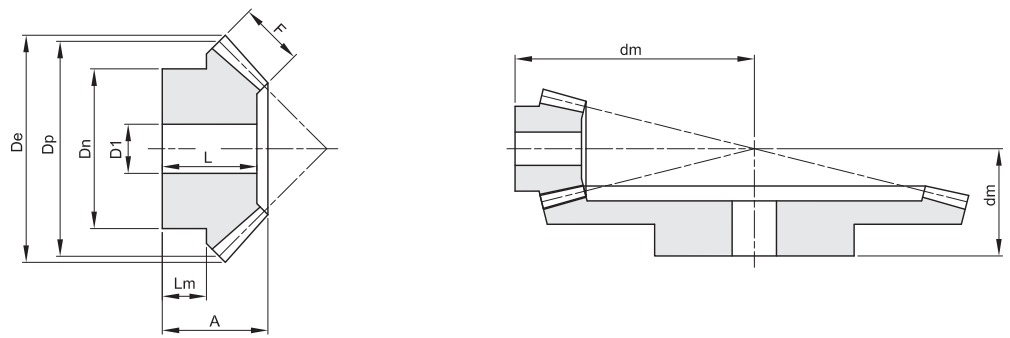

Materiale acciaio C45

modulo	dent	De	Dp	A	F	Dn	D1	dm	L	Lm	Kg.
1,5	16	26,9	24	25	12	18	10	61,1	24	12,2	0,04
1,5	64	96,7	96	25	12	60	15	33	22	13	0,75
2	16	35,9	32	24	15	25	12	73,1	23	8,5	0,08
2	64	129,0	128	28	15	70	20	38,9	24	14	1,35
2,5	16	44,9	40	30,5	18	34	15	92,6	29	11,7	0,18
2,5	64	161,2	160	35	18	80	20	48,8	30	16	2,70
3	16	53,8	48	32	20	40	15	108	30	11,1	0,29
3	64	193,5	192	42	20	90	20	58,8	36	22	4,12
3,5	16	62,8	56	40	25	45	15	127,1	38	14	0,48
3,5	64	225,7	224	50	25	100	25	69,3	43	22	7,53
4	16	71,7	64	50	30	50	20	148,2	48	18,5	0,75
4	64	257,9	256	60	30	110	28	81,8	52	30	10,66
4,5	16	80,7	72	55	32	60	20	167,1	53	21,6	1,12
4,5	64	290,1	288	65	32	120	30	89,8	57	35	13,80
5	16	89,7	80	60	35	65	20	185,1	58	23,2	1,54
5	64	322,4	320	70	35	120	30	97,7	61	42	15,60

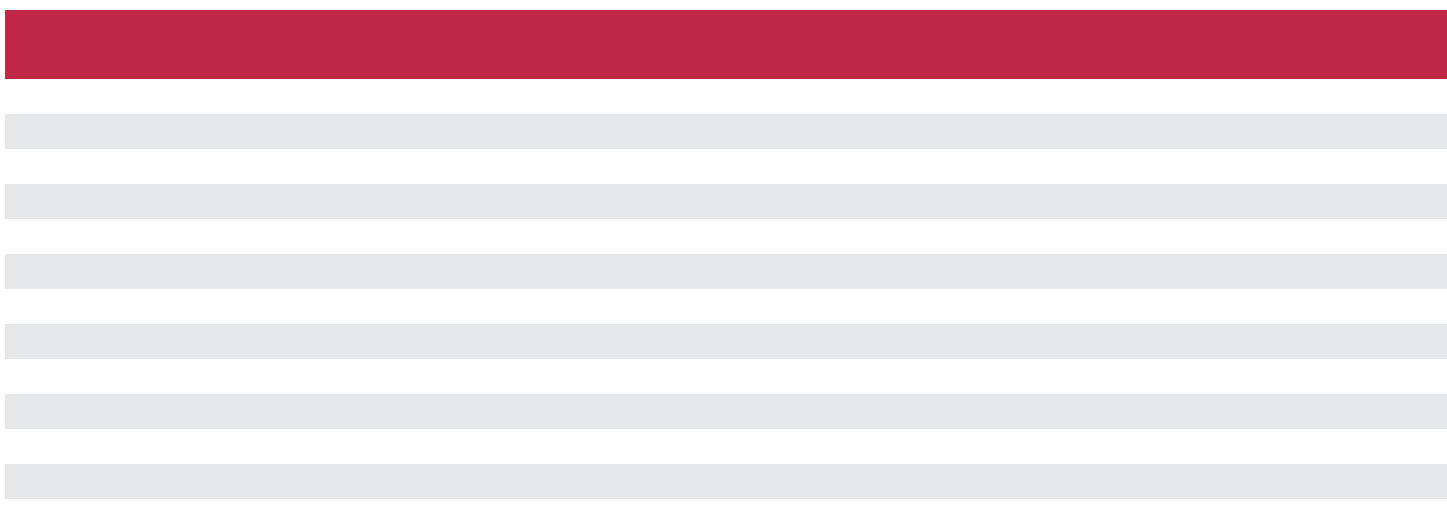
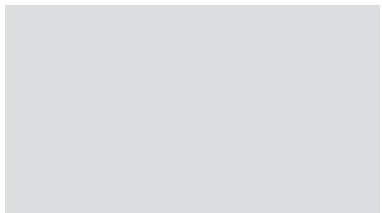

RUOTE DENTATE CONICHE DENTI DIRITTI TIPO "B"

CONICAL STRAIGHT TOOTHED GEARS TYPE "B"

RAPPORTO 1:1

ANGOLO DI PRESSIONE **20°**

ANGOLO FRA GLI ALBERI $\Sigma = 90^\circ$

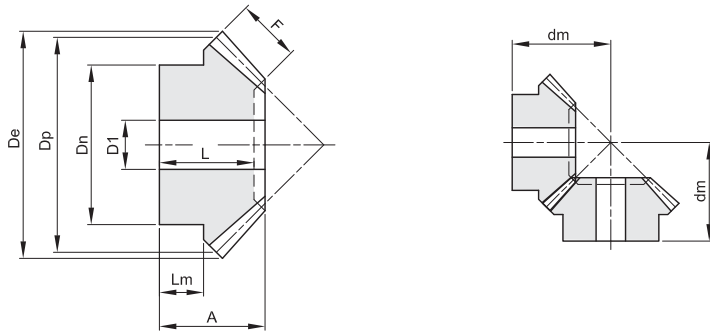

Materiale acciaio C45

modulo	denti	De	Dp	A	F	Dn	D1	dm	L	Lm	Kg.
1	16	17,4	16,0	11,2	4	13,3	4	16		6,7	0,02
1	19	20,4	19,0	11,8	4	15,3	4	18		6,6	0,02
1	22	23,4	22,0	12,8	4,7	16,3	5	20		6,1	0,02
1	26	27,4	26,0	13,3	5,5	20,3	5	22		7	0,04
1	30	31,4	30,0	16,0	6,4	20,3	5	26		8	0,05
1,5	16	26,1	24,0	18,9	6	20,3	8	26		12,2	0,04
1,5	19	30,6	28,5	21,3	7	20,3	8	30		11,6	0,05
1,5	22	35,1	33,0	22,5	7,5	25,3	8	33		12,7	0,09
1,5	26	41,1	39,0	23,2	8,5	28,3	8	36		12	0,12
1,5	30	47,1	45,0	27,2	10	30,0	12	42		12,1	0,17
2	16	34,8	32,0	23,5	8	25,3	8	33		13,6	0,08
2	19	40,8	38,0	24,2	9	25,3	8	36		12	0,11
2	22	46,8	44,0	27,9	10	30,3	10	42		14	0,18
2	26	54,8	52,0	31,4	12	35,3	12	48		13,7	0,28
2	30	62,8	60,0	34,1	13	40,3	12	54		17	0,41
2,5	16	43,5	40,0	28,1	10	30,3	12	40		15,2	0,14
2,5	19	51,0	47,5	27,1	11	35,3	12	42		13	0,21
2,5	22	58,5	55,0	30,1	12	45,3	12	48		15,7	0,36
2,5	26	68,5	65,0	33,2	15	45,3	15	54		16	0,47
2,5	30	78,5	75,0	39,0	16	50,3	15	64		20	0,74
3	16	52,2	48,0	31,7	12	40,3	12	46		18,1	0,28
3	19	61,2	57,0	36,0	13	40,3	14	54		17,1	0,39
3	22	70,2	66,0	36,9	15	50,3	15	58		17,1	0,59
3	26	82,2	78,0	38,4	17	50,3	15	64		18	0,77
3	30	94,2	90,0	43,8	19	60,3	20	74		22	1,19
3,5	16	60,9	56,0	36,4	14	45,3	15	53		19,8	0,41
3,5	19	71,4	66,5	36,9	15	50,3	15	58		18	0,59
3,5	22	81,9	77,0	39,1	17	55,3	15	64		18	0,84
3,5	26	95,9	91,0	42,2	20	60,3	20	72		20	1,17
3,5	30	110,0	105,0	47,3	23	70,3	20	82	43	22	1,69
4	16	69,7	64,0	44,3	15	50,3	15	64		25,1	0,66
4	19	81,7	76,0	44,4	18	55,3	18	68		22	0,88
4	22	93,7	88,0	45,9	20	60,3	18	74		22	1,21
4	26	109,7	104,0	48,0	23	70,3	20	82	43	22	1,68
4	30	125,7	120,0	54,2	26	80,3	25	94	49	25	2,50
4,5	16	78,4	72,0	46,3	17,5	55,3	18	68		25	0,84
4,5	19	91,8	85,5	47,3	20	60,3	20	74		25	1,15
4,5	22	105,3	99,0	50,1	22	70,3	20	82		25	1,72
4,5	26	123,3	117,0	53,2	25	75,3	20	92	45	25	2,22
4,5	30	141,4	135,0	60,0	29	80,3	25	105	54	28	3,25
5	16	87,1	80,0	48,9	18	60,3	20	74		25	1,10
5	19	102,1	95,0	52,2	22	60,3	20	82		25	1,50
5	22	117,1	110,0	58,2	24	80,3	20	94	52	30	2,39
5	26	137,1	130,0	62,7	29	80,3	20	105	57	30	3,27
5	30	157,1	150,0	68,9	32	80,3	30	119	63	35	4,13

RUOTE DENTATE CONICHE DENTI DIRITTI TIPO "B" CONICAL STRAIGHT TOOTHED GEARS TYPE "B"

RAPPORTO 1:2
 ANGOLO DI PRESSIONE 20°
 ANGOLO FRA GLI ALBERI $\Sigma = 90^\circ$

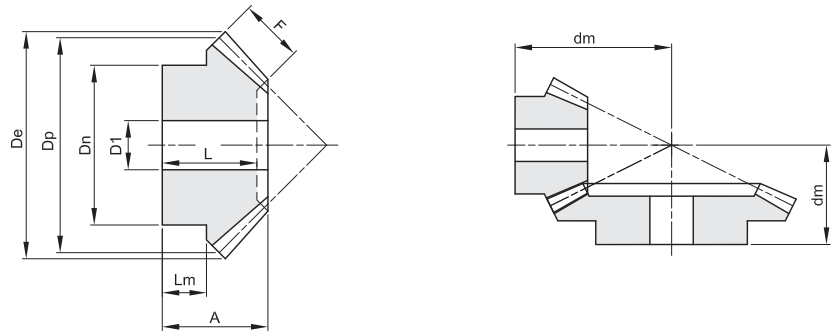

Materiale acciaio C45

modulo	denti	De	Dp	A	F	Dn	D1	dm	L	Lm	Kg.
1	15	17,4	15,0	11,9	5	13,3	4	22		6,6	0,02
1	30	30,6	30,0	15,1	5	20,3	5	20	14	9	0,05
1,5	15	26,1	22,5	21,1	9	20,3	8	35		12	0,04
1,5	30	45,9	45,0	25,2	9	32,3	8	32	23	16	0,17
2	15	34,8	30,0	26	11,5	25,3	8	45		13,8	0,09
2	30	61,2	60,0	29,8	11,5	40,3	12	39	27	18	0,32
2,5	15	43,5	37,5	31,8	15	32,3	12	55		16,2	0,17
2,5	30	76,5	75,0	33,7	15	45,3	15	45	30	20	0,50
3	15	52,2	45,0	37,3	17	40,3	12	66		19,8	0,33
3	30	91,8	90,0	42,1	17	55,3	15	56	38	25	0,96
3,5	15	60,9	52,5	46,1	20,5	45,3	15	79		24,7	0,50
3,5	30	107,1	105,0	45	20,5	60,3	20	61	40	25	1,31
4	15	69,6	60,0	48,6	22,5	50,3	20	87		24,6	0,65
4	30	122,3	120,0	57,3	22,5	80,3	20	76	52	35	2,52
4,5	15	78,3	67,5	51,4	26	60,3	20	94		24,7	0,97
4,5	30	137,6	135,0	60,3	26	80,3	25	81	53	35	2,95
5	15	87,0	75,0	57,6	30	60,3	20	104		25,3	1,23
5	30	152,9	150,0	62,5	30	80,3	25	85	56	35	3,56

RAPPORTO 1:3
 ANGOLO DI PRESSIONE 20°
 ANGOLO FRA GLI ALBERI $\Sigma = 90^\circ$

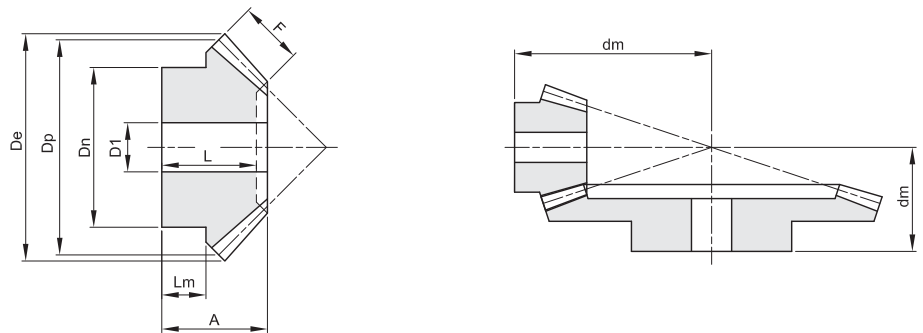

Materiale acciaio C45

modulo	denti	De	Dp	A	F	Dn	D1	dm	L	Lm	Kg.
1	15	17,7	15,0	16,6	7,1	13,3	4	32		9,3	0,02
1	45	45,3	45,0	17,1	7,1	25,3	8	22	15	10	0,09
1,5	15	26,5	22,5	22,6	10,5	19,3	8	46		11,7	0,04
1,5	45	68,1	67,5	29,6	10,5	45,3	14	37	27	20	0,40
2	15	35,4	30,0	28,9	14	25,3	8	60		14,2	0,11
2	45	90,8	90,0	32,1	14	45,3	15	42	29	20	0,62
2,5	15	44,2	37,5	34,6	18	32,3	12	73		15,9	0,20
2,5	45	113,4	112,5	39,7	18	60,3	20	52	36	25	1,23
3	15	53,0	45,0	41,3	21	40,3	15	88		19,7	0,35
3	45	136,1	135,0	47,2	21	60,3	20	62	42,5	30	1,83
3,5	15	61,9	52,5	49,6	23,5	45,3	15	105		25,1	0,57
3,5	45	158,8	157,5	54,4	23,5	80,3	20	72	49	35	3,21
4	15	70,7	60,0	54,3	27,5	50,3	20	117		25,4	0,75
4	45	181,5	180,0	57,0	27,5	80,3	22	77	51	35	2,53
4,5	15	79,5	67,5	55,2	28,5	55,3	20	128		24,8	1,02
4,5	45	204,2	202,5	63,9	28,5	90,3	25	87	57	40	5,70
5	15	88,4	75,0	65,3	33	60,3	20	145		30	1,47
5	45	226,9	225,0	66,7	33	90,3	28	92	59	40	7,22

RUOTE DENTATE CONICHE DENTI DIRITTI TIPO "B" CONICAL STRAIGHT TOOTHED GEARS TYPE "B"

RAPPORTO 1:4
 ANGOLO DI PRESSIONE **20°**
 ANGOLO FRA GLI ALBERI $\Sigma = 90^\circ$

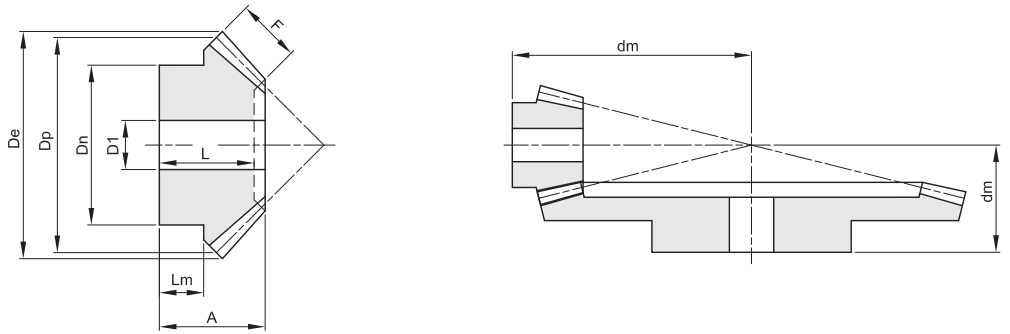

Materiale acciaio C45

modulo	denti	De	Dp	A	F	Dn	D1	dm	L	Lm	Kg.
1	15	17,8	15,0	17,2	9,3	13,3	4	38		7,7	0,02
1	60	60,3	60,0	17,1	9,3	30,3	8	22	15	10	0,16
1,5	15	26,7	22,5	23,0	11	20,3	8	57		11,7	0,05
1,5	60	90,4	90,0	34	11	50,3	15	42	31	25	0,63
2	15	35,6	30,0	31	16	25,3	8	75		14,4	0,12
2	60	120,6	120,0	37,6	16	60,3	16	48	34	25	1,28
2,5	15	44,5	37,5	38,1	19	32,3	14	94		18,4	0,21
2,5	60	150,7	150,0	44,8	19	60,3	20	58	40	30	1,92
3	15	53,3	45,0	48,1	23	40,3	15	115		24,5	0,42
3	60	180,8	180,0	53,2	23	80,3	20	69	48	35	3,75
3,5	15	62,2	52,5	52,1	26	45,3	15	131		25,1	0,62
3,5	60	211,0	210,0	60,4	26	90,3	25	79	54	40	5,60
4	15	71,1	60,0	55,1	30	50,3	20	145		23,8	0,81
4	60	241,1	240,0	60,8	30	90,3	28	82	53	40	6,43
4,5	15	79,9	67,5	59,1	34	60,3	20	160		24,1	1,17
4,5	60	271,2	270,0	68,2	34	100,3	30	92	61	40	11,30
5	15	88,8	75,0	68,1	38	70,3	20	180		29,4	1,85
5	60	301,3	300,0	73,5	38	110,3	30	100	66	40	16,51

RUOTE DENTATE CONICHE DENTI SPIROIDALI

CONICAL SPIRAL TOOTHED GEARS

RAPPORTO 1:1
 ANGOLO DI PRESSIONE 20°
 ANGOLO FRA GLI ALBERI $\Sigma = 90^\circ$

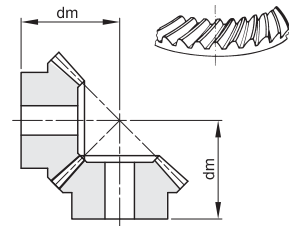
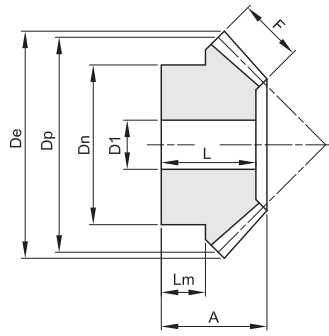

RUOTA MINORE CON ELICA SINISTRORSA
 RUOTA MAGGIORE CON ELICA DESTROSA

Materiale acciaio C45

modulo	denti	De	Dp	A	F	Dn	D1	dm	L	Lm	Kg.
2	16	34,4	32,0	20,1	9	25	10	29	17,0	9,5	0,06
2	20	42,4	40,0	25,2	12	32	10	36	22,0	12	0,14
2	25	52,4	50,0	27,6	14	40	12	42	24,5	12	0,25
2	30	62,4	60,0	30,1	16	50	12	48	27,0	13	0,42
2,5	16	43,0	40,0	25,0	10	32	12	37	22,0	13	0,13
2,5	20	53,0	50,0	30,5	12	40	12	46	27,5	16	0,27
2,5	25	65,5	62,5	33,3	15	50	15	53	30,0	16	0,47
2,5	30	78,0	75,0	35,2	18	55	15	59	32,0	16	0,69
3	16	51,6	48,0	29,7	12	40	15	44	26,0	16	0,23
3	20	63,6	60,0	34,8	18	45	15	51	31,0	13,5	0,41
3	25	78,6	75,0	37,8	20	55	15	60	34,0	16	0,72
3	30	93,6	90,0	39,7	22	60	20	68	36,0	19	0,99
3,5	16	60,2	56,0	34,3	14	45	15	51	30,0	17,5	0,36
3,5	20	74,2	70,0	36,1	15	55	15	59	31,5	19	0,62
3,5	25	91,7	87,5	40,5	21	65	20	68	36,0	18	1,11
3,5	30	109,2	105,0	41,9	24	70	20	76	37,5	17	1,64
4	16	68,8	64,0	36,2	15	50	15	56	31,0	17	0,51
4	20	84,8	80,0	37,7	17	60	18	64	32,5	18	0,81
4	25	104,8	100,0	40,5	21	70	20	74	35,0	18	1,33
4	30	124,8	120,0	43,4	25	80	25	84	38,0	16	2,10
4,5	16	77,4	72,0	39,5	15	55	18	63	33,5	18,5	0,67
4,5	20	95,4	90,0	43,0	20	65	20	72	37,0	18	1,14
4,5	25	117,9	112,5	45,3	25	75	20	82	39,0	18	1,87
4,5	30	140,4	135,0	48,2	28	90	25	94	42,0	17	2,98
5	16	86,0	80,0	42,1	17	60	20	68	36,0	18	0,88
5	20	106,0	100,0	45,0	21	70	20	78	38,5	18,5	1,47
5	25	131,0	125,0	48,0	26	90	20	90	41,5	18,5	2,67
5	30	156,0	150,0	52,7	32	110	30	103	46,0	18	4,25

RUOTE DENTATE CONICHE DENTI SPIROIDALI

CONICAL SPIRAL TOOTHED GEARS

RAPPORTO 1:2

ANGOLO DI PRESSIONE 20°

ANGOLO FRA GLI ALBERI $\Sigma = 90^\circ$

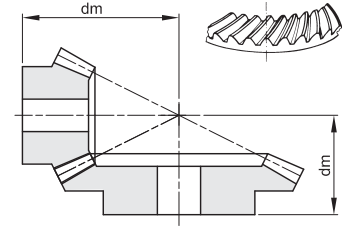
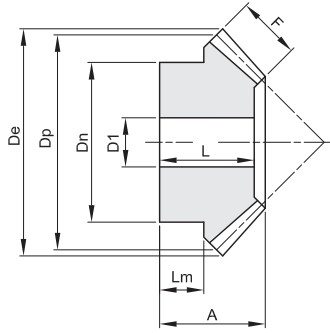

RUOTA MINORE CON ELICA SINISTRORSA
RUOTA MAGGIORE CON ELICA DESTROSA

Materiale acciaio C45

modulo	denti	De	Dp	A	F	Dn	D1	dm	L	Lm	Kg.
2	16	36,1	32	22,6	10	27	10	45	21,0	11,7	0,09
2	32	65,0	64	24,1	10	40	12	35	21,5	10	0,32
2,5	16	45,1	40	27,6	12	34	12	56	25,5	14,5	0,17
2,5	32	81,2	80	29,2	12	50	15	43	25,5	15	0,57
3	16	54,1	48	28,4	15	40	15	62	25,5	12	0,25
3	32	97,5	96	34,6	15	60	15	51	30,0	15	1,03
3,5	16	63,2	56	33,3	18	48	15	72	30,5	14	0,42
3,5	32	113,7	112	39,1	18	70	20	58	34,0	19	1,51
4	16	72,2	64	36,3	20	50	20	81	32,5	13,5	0,52
4	32	130,0	128	44,2	20	80	20	66	38,5	23	2,21
4,5	16	81,2	72	40,2	22	60	20	91	35,5	16	0,80
4,5	32	146,2	144	49,3	22	80	25	74	42,5	24	2,88
5	16	90,2	80	50,1	25	60	20	106	45,5	21	1,16
5	32	162,5	160	53,7	25	85	25	81	46,5	27	2,79

RAPPORTO 1:3

ANGOLO DI PRESSIONE 20°

ANGOLO FRA GLI ALBERI $\Sigma = 90^\circ$

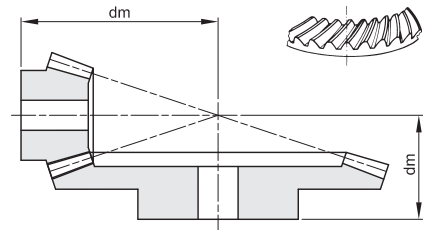
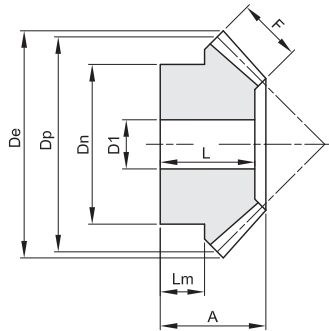

RUOTA MINORE CON ELICA SINISTRORSA
RUOTA MAGGIORE CON ELICA DESTROSA

Materiale acciaio C45

modulo	denti	De	Dp	A	F	Dn	D1	dm	L	Lm	Kg.
2	16	36,5	32	25,7	15	25	12	59	24,0	9,7	0,09
2	48	96,6	96	25,3	15	50	15	36	21,5	13	0,62
2,5	16	45,7	40	27,7	18	33	14	70	26,0	8,9	0,17
2,5	48	120,8	120	31,4	18	60	20	45	26,5	16	1,19
3	16	54,8	48	29,9	18	42	15	84	28,0	11	0,29
3	48	145,0	144	36,7	18	65	20	54	31,0	19	1,91
3,5	16	63,9	56	36,8	22	48	15	99	34,0	13,6	0,48
3,5	48	169,1	168	43,1	22	75	20	63	36,0	23	2,31
4	16	73,1	64	41,8	25	55	20	113	39,0	15,5	0,70
4	48	193,3	192	49,2	25	85	22	72	41,0	27	4,21
4,5	16	82,2	72	53,8	28	60	20	134	50,0	24	1,14
4,5	48	217,4	216	56,3	28	90	25	82	47,5	27	7,03
5	16	91,4	80	60,5	35	60	20	146	57,0	22,7	1,45
5	48	241,6	240	63,5	35	100	28	91	53,5	35	8,42

RUOTE DENTATE CONICHE DENTI SPIROIDALI

CONICAL SPIRAL TOOTHED GEARS

RAPPORTO 1:4
 ANGOLO DI PRESSIONE 20°
 ANGOLO FRA GLI ALBERI $\Sigma = 90^\circ$

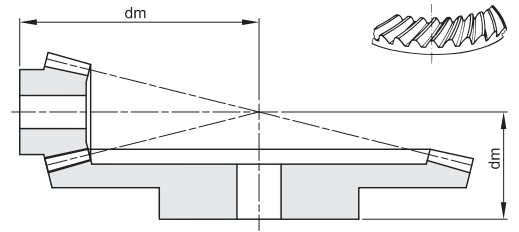
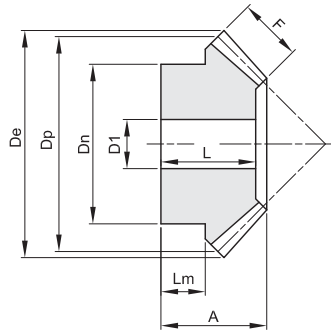

RUOTA MINORE CON ELICA SINISTRORSA
 RUOTA MAGGIORE CON ELICA DESTROSA

Materiale acciaio C45

modulo	denti	De	Dp	A	F	Dn	D1	dm	L	Lm	Kg.
2	16	36,7	32	24	15	25	12	73	23,0	8,2	0,09
2	64	128,5	128	27,3	15	70	20	39	23,0	14	1,30
2,5	16	45,9	40	31	18	34	15	93	29,0	12,2	0,20
2,5	64	160,6	160	34,2	18	80	20	49	29,0	16	2,59
3	16	55,1	48	32,1	20	40	15	108	30,0	11	0,31
3	64	192,7	192	40,9	20	90	20	59	35,0	22	3,94

PULEGGE DENTATE PER CINGHIE POSITIVE SYNCHROBELT® - ISO 5294

TIMING BELT PULLEYS - ISO 5294

MXL 025
PASSO 0,80" (2,032 mm)
PER CINGHIE LARGHEZZA 1/4" (6,35 mm)

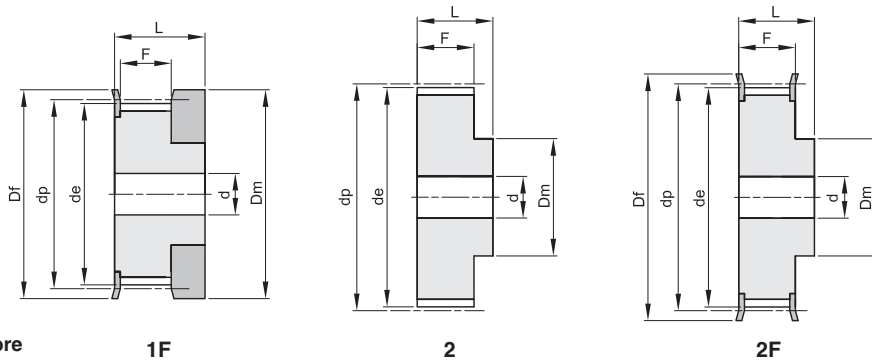

Materiale: Alluminio UNI 9006 - T6 (Al)
 adatto per l'ossidazione dura a spessore

codice	tipo	materiale	denti	dp	de	Df	Dm	F	L	d	n° flangia	Kg.
16 MXL 025	1F	Al	16	10,35	9,84	15	15	8,5	16		101	0,01
18 MXL 025	1F	Al	18	11,64	11,13	16	16	8,5	16		102	0,01
20 MXL 025	1F	Al	20	12,94	12,43	16	16	8,5	16		102	0,01
22 MXL 025	2F	Al	22	14,23	13,72	18	10	11	16	3	104	0,01
24 MXL 025	2F	Al	24	15,52	15,02	18	10	11	16	3	104	0,01
28 MXL 025	2F	Al	28	18,11	17,60	23	11	11	16	3	107	0,01
30 MXL 025	2F	Al	30	19,40	18,90	23	12	11	16	4	107	0,02
32 MXL 025	2F	Al	32	20,70	20,19	25	14	11	16	4	108	0,02
36 MXL 025	2F	Al	36	23,29	22,78	28	16	11	16	4	109	0,02
40 MXL 025	2F	Al	40	25,87	25,36	32	18	11	16	4	110	0,03
42 MXL 025	2F	Al	42	27,17	26,66	32	18	11	16	5	110	0,03
44 MXL 025	2F	Al	44	28,46	27,95	36	18	11	16	5	111	0,03
48 MXL 025	2	Al	48	31,05	30,54		20	11	16	5		0,03
60 MXL 025	2	Al	60	38,81	38,30		24	11	16	5		0,04
72 MXL 025	2	Al	72	46,57	46,06		25	11	16	6		0,05

PULEGGE DENTATE PER CINGHIE POSITIVE SYNCHROBELT® - ISO 5294

TIMING BELT PULLEYS - ISO 5294

XL 037

PASSO 1/5" (5,08 mm)

PER CINGHIE LARGHEZZA 3/8" (9,52 mm)

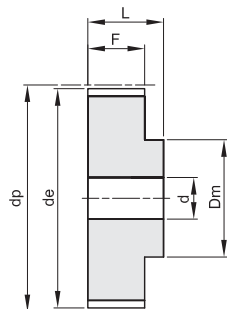

2

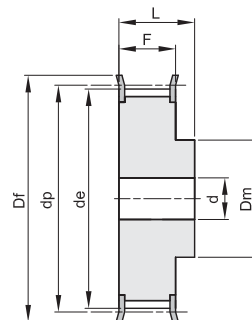

2F

Materiale: Alluminio UNI 9006 - T6 (Al)
adatto per l'ossidazione dura a spessore

codice	tipo	materiale	denti	dp	de	Df	Dm	F	L	d	n° flangia	Kg.
10 XL 037	2F	Al	10	16,17	15,66	23	10	14,3	20		201	0,01
11 XL 037	2F	Al	11	17,79	17,28	23	10	14,3	20		201	0,01
12 XL 037	2F	Al	12	19,40	18,90	25	10	14,3	20		203	0,01
13 XL 037	2F	Al	13	21,02	20,51	25	10	14,3	20		203	0,01
14 XL 037	2F	Al	14	22,64	22,13	28	16	14,3	20		204	0,02
15 XL 037	2F	Al	15	24,25	23,75	28	16	14,3	20		204	0,02
16 XL 037	2F	Al	16	25,87	25,36	32	16	14,3	20		205	0,03
17 XL 037	2F	Al	17	27,49	26,98	32	20	14,3	20		205	0,03
18 XL 037	2F	Al	18	29,11	28,60	36	20	14,3	20		206	0,04
19 XL 037	2F	Al	19	30,72	30,21	36	20	14,3	22		206	0,04
20 XL 037	2F	Al	20	32,34	31,83	38	25	14,3	22		207	0,05
21 XL 037	2F	Al	21	33,96	33,45	38	25	14,3	22		207	0,05
22 XL 037	2F	Al	22	35,57	35,07	42	25	14,3	22		208	0,06
24 XL 037	2F	Al	24	38,81	38,30	44	30	14,3	22		209	0,06
26 XL 037	2F	Al	26	42,04	41,53	48	30	14,3	22	8	210	0,09
27 XL 037	2F	Al	27	43,66	43,15	48	34	14,3	22	8	210	0,09
28 XL 037	2F	Al	28	45,28	44,77	51	34	14,3	22	8	211	0,10
30 XL 037	2F	Al	30	48,51	48,00	54	38	14,3	22	8	212	0,12
32 XL 037	2F	Al	32	51,74	51,24	57	38	14,3	25	8	213	0,12
34 XL 037	2F	Al	34	54,98	54,47	60	38	14,3	25	8	214	0,13
35 XL 037	2F	Al	35	56,60	56,09	63	38	14,3	25	8	215	0,14
36 XL 037	2	Al	36	58,21	57,70		45	14,3	25	8		0,14
38 XL 037	2	Al	38	61,45	60,94		45	14,3	25	8		0,15
40 XL 037	2	Al	40	64,68	64,17		45	14,3	25	8		0,16
42 XL 037	2	Al	42	67,91	67,41		45	14,3	25	8		0,18
44 XL 037	2	Al	44	71,15	70,64		45	14,3	25	8		0,19
48 XL 037	2	Al	48	77,62	77,11		45	14,3	25	10		0,19
52 XL 037	2	Al	52	84,08	83,57		45	14,3	25	10		0,19
60 XL 037	2	Al	60	97,02	96,51		45	14,3	25	10		0,22
72 XL 037	2	Al	72	116,42	115,92		45	14,3	25	10		0,44

PULEGGE DENTATE PER CINGHIE POSITIVE SYNCHROBELT® - ISO 5294

TIMING BELT PULLEYS - ISO 5294

L 050

PASSO 3/8" (9,525 mm)
PER CINGHIE LARGHEZZA 1/2" (12,7 mm)

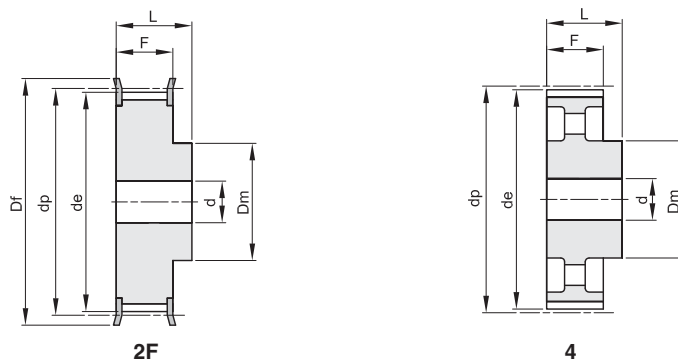

Materiale: Acciaio (St)
 Materiale: Ghisa (GG)

codice	tipo	materiale	denti	dp	de	Df	Dm	F	L	d	n° flangia	Kg.
10 L 050	2F	St	10	30,32	29,56	36	20	19,0	28	8	300	0,11
11 L 050	2F	St	11	33,35	32,59	38	24	19,0	30	8	301	0,14
12 L 050	2F	St	12	36,38	35,62	42	24	19,0	30	8	302	0,17
13 L 050	2F	St	13	39,41	38,65	44	28	19,0	30	8	303	0,21
14 L 050	2F	St	14	42,44	41,68	48	28	19,0	30	8	304	0,24
15 L 050	2F	St	15	45,48	44,72	51	34	19,0	30	8	305	0,29
16 L 050	2F	St	16	48,51	47,75	54	36	19,0	32	8	306	0,33
17 L 050	2F	St	17	51,54	50,78	57	36	19,0	32	10	307	0,38
18 L 050	2F	St	18	54,57	53,81	60	40	19,0	32	10	308	0,44
19 L 050	2F	St	19	57,61	56,84	63	40	19,0	32	10	309	0,47
20 L 050	2F	St	20	60,64	59,88	66	40	19,0	32	10	310	0,51
21 L 050	2F	St	21	63,67	62,91	71	45	19,0	32	10	311	0,60
22 L 050	2F	St	22	66,70	65,94	75	45	19,0	32	10	312	0,64
23 L 050	2F	St	23	69,73	68,97	79	55	19,0	32	10	313	0,78
24 L 050	2F	St	24	72,77	72,00	79	55	19,0	32	10	313	0,81
25 L 050	2F	St	25	75,80	75,04	83	58	19,0	32	10	314	0,89
26 L 050	2F	St	26	78,83	78,07	87	58	19,0	32	12	315	0,94
27 L 050	2F	St	27	81,86	81,10	87	58	19,0	32	12	315	0,99
28 L 050	2F	St	28	84,89	84,13	91	58	19,0	32	12	316	1,04
30 L 050	2F	St	30	90,96	90,20	97	70	19,0	32	12	318	1,17
32 L 050	2F	St	32	97,03	96,26	103	70	19,0	32	12	320	1,41
33 L 050	2F	St	33	100,05	99,29	106	70	19,0	32	12	321	1,49
34 L 050	2F	St	34	103,08	102,32	111	70	19,0	32	12	322	1,57
35 L 050	2F	St	35	106,12	105,35	111	70	19,0	32	12	322	1,62
36 L 050	2F	St	36	109,15	108,39	115	70	19,0	32	12	323	1,70
40 L 050	2F	St	40	121,29	120,51	127	70	19,0	32	12	327	2,03
42 L 050	2F	St	42	127,34	126,58	135	70	19,0	32	12	328	2,21
44 L 050	2F	St	44	133,40	132,64	140	70	19,0	32	12	330	2,38
45 L 050	2F	St	45	136,44	135,67	143	70	19,0	32	12	331	2,48
48 L 050	2F	St	48	145,53	144,77	152	70	19,0	32	12	334	2,78
50 L 050	4	GG	50	151,60	150,83		70	19,0	32	14		1,74
52 L 050	4	GG	52	157,66	156,90		70	19,0	32	14		1,80
56 L 050	4	GG	56	169,79	169,02		70	19,0	32	14		1,87
57 L 050	4	GG	57	172,82	172,06		70	19,0	32	14		1,88
60 L 050	4	GG	60	181,91	181,15		75	19,0	42	14		2,41
72 L 050	4	GG	72	218,29	217,53		75	19,0	42	14		2,82
84 L 050	4	GG	84	254,68	253,92		75	19,0	42	14		3,08
96 L 050	4	GG	96	291,06	290,30		75	19,0	42	14		3,42

PULEGGE DENTATE PER CINGHIE POSITIVE SYNCHROBELT® - ISO 5294

TIMING BELT PULLEYS - ISO 5294

L 075

PASSO 3/8" (9,525 mm)

PER CINGHIE LARGHEZZA 3/4" (19,05 mm)

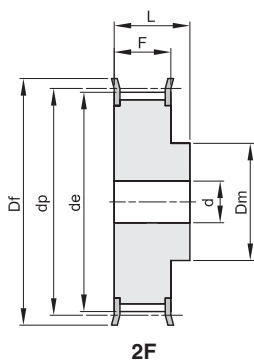

2F

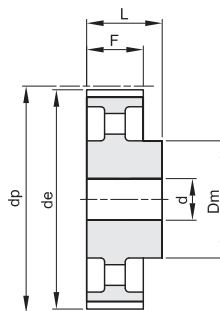

4

Materiale: Acciaio (St)
Materiale: Ghisa (GG)

codice	tipo	materiale	denti	dp	de	Df	Dm	F	L	d	n° flangia	Kg.
10 L 075	2F	St	10	30,32	29,56	36	20	25,4	38	8	300	0,14
11 L 075	2F	St	11	33,35	32,59	38	24	25,4	38	8	301	0,18
12 L 075	2F	St	12	36,38	35,62	42	24	25,4	38	8	302	0,22
13 L 075	2F	St	13	39,41	38,65	44	28	25,4	38	8	303	0,26
14 L 075	2F	St	14	42,44	41,68	48	28	25,4	38	8	304	0,30
15 L 075	2F	St	15	45,48	44,72	51	34	25,4	38	8	305	0,37
16 L 075	2F	St	16	48,51	47,75	54	36	25,4	38	8	306	0,43
17 L 075	2F	St	17	51,54	50,78	57	36	25,4	38	10	307	0,46
18 L 075	2F	St	18	54,57	53,81	60	40	25,4	38	10	308	0,54
19 L 075	2F	St	19	57,61	56,84	63	40	25,4	38	10	309	0,58
20 L 075	2F	St	20	60,64	59,88	66	40	25,4	38	10	310	0,64
21 L 075	2F	St	21	63,67	62,91	71	45	25,4	38	10	311	0,71
22 L 075	2F	St	22	66,70	65,94	75	45	25,4	38	10	312	0,79
23 L 075	2F	St	23	69,73	68,97	79	55	25,4	38	10	313	0,94
24 L 075	2F	St	24	72,77	72,00	79	55	25,4	38	10	313	1,00
25 L 075	2F	St	25	75,80	75,04	83	58	25,4	38	10	314	1,10
26 L 075	2F	St	26	78,83	78,07	87	58	25,4	38	12	315	1,16
27 L 075	2F	St	27	81,86	81,10	87	58	25,4	38	12	315	1,22
28 L 075	2F	St	28	84,89	84,13	91	58	25,4	38	12	316	1,30
30 L 075	2F	St	30	90,96	90,20	97	70	25,4	38	12	318	1,47
32 L 075	2F	St	32	97,03	96,26	103	70	25,4	38	12	320	1,75
33 L 075	2F	St	33	100,05	99,29	106	70	25,4	38	12	321	1,85
34 L 075	2F	St	34	103,08	102,32	111	70	25,4	38	12	322	1,93
35 L 075	2F	St	35	106,12	105,35	111	70	25,4	38	12	322	2,03
36 L 075	2F	St	36	109,15	108,39	115	70	25,4	38	12	323	2,14
40 L 075	2F	St	40	121,29	120,51	127	70	25,4	38	12	327	2,56
42 L 075	2F	St	42	127,34	126,58	135	70	25,4	38	12	328	2,81
44 L 075	2F	St	44	133,40	132,64	140	70	25,4	38	12	330	3,02
45 L 075	2F	St	45	136,44	135,67	143	70	25,4	38	12	331	3,16
48 L 075	2F	St	48	145,53	144,77	152	70	25,4	38	12	334	3,57
50 L 075	4	GG	50	151,60	150,83		70	25,4	38	14		2,10
52 L 075	4	GG	52	157,66	156,90		70	25,4	38	14		2,13
56 L 075	4	GG	56	169,79	169,02		70	25,4	38	14		2,27
57 L 075	4	GG	57	172,82	172,06		70	25,4	38	14		2,28
60 L 075	4	GG	60	181,91	181,15		75	25,4	45	14		2,70
72 L 075	4	GG	72	218,29	217,53		75	25,4	45	14		3,19
84 L 075	4	GG	84	254,68	253,92		75	25,4	45	14		3,64
96 L 075	4	GG	96	291,06	290,30		75	25,4	45	14		4,04

PULEGGE DENTATE PER CINGHIE POSITIVE SYNCHROBELT® - ISO 5294

TIMING BELT PULLEYS - ISO 5294

L 100

PASSO 3/8" (9,525 mm)

PER CINGHIE LARGHEZZA 1" (25,4 mm)

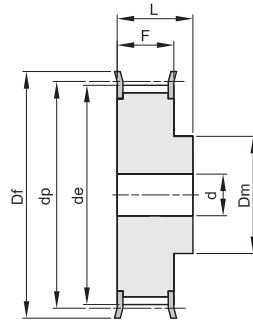

2F

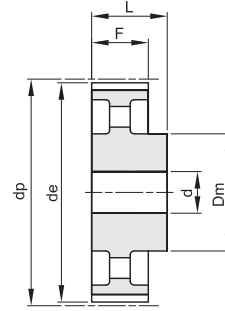

4

Materiale: Acciaio (St)
Materiale: Ghisa (GG)

codice	tipo	materiale	denti	dp	de	Df	Dm	F	L	d	n° flangia	Kg.
10 L 100	2F	St	10	30,32	29,56	36	20	31,8	45	8	300	0,17
11 L 100	2F	St	11	33,35	32,59	38	24	31,8	45	8	301	0,22
12 L 100	2F	St	12	36,38	35,62	42	24	31,8	45	8	302	0,26
13 L 100	2F	St	13	39,41	38,65	44	28	31,8	45	8	303	0,32
14 L 100	2F	St	14	42,44	41,68	48	28	31,8	45	10	304	0,35
15 L 100	2F	St	15	45,48	44,72	51	34	31,8	45	10	305	0,43
16 L 100	2F	St	16	48,51	47,75	54	36	31,8	45	10	306	0,50
17 L 100	2F	St	17	51,54	50,78	57	36	31,8	45	10	307	0,56
18 L 100	2F	St	18	54,57	53,81	60	40	31,8	45	10	308	0,64
19 L 100	2F	St	19	57,61	56,84	63	40	31,8	45	10	309	0,70
20 L 100	2F	St	20	60,64	59,88	66	40	31,8	45	10	310	0,77
21 L 100	2F	St	21	63,67	62,91	71	45	31,8	45	10	311	0,88
22 L 100	2F	St	22	66,70	65,94	75	45	31,8	45	12	312	0,95
23 L 100	2F	St	23	69,73	68,97	79	55	31,8	45	12	313	1,11
24 L 100	2F	St	24	72,77	72,00	79	55	31,8	45	12	313	1,18
25 L 100	2F	St	25	75,80	75,04	83	58	31,8	45	12	314	1,30
26 L 100	2F	St	26	78,83	78,07	87	58	31,8	45	12	315	1,40
27 L 100	2F	St	27	81,86	81,10	87	58	31,8	45	12	315	1,47
28 L 100	2F	St	28	84,89	84,13	91	58	31,8	45	12	316	1,58
30 L 100	2F	St	30	90,96	90,20	97	70	31,8	45	12	318	1,78
32 L 100	2F	St	32	97,03	96,26	103	70	31,8	45	12	320	2,11
33 L 100	2F	St	33	100,05	99,29	106	70	31,8	45	12	321	2,23
34 L 100	2F	St	34	103,08	102,32	111	70	31,8	45	12	322	2,39
35 L 100	2F	St	35	106,12	105,35	111	70	31,8	45	12	322	2,45
36 L 100	2F	St	36	109,15	108,39	115	70	31,8	45	12	323	2,59
40 L 100	2F	St	40	121,29	120,51	127	70	31,8	45	12	327	3,13
42 L 100	2F	St	42	127,34	126,58	135	70	31,8	45	12	328	3,43
44 L 100	2F	St	44	133,40	132,64	140	70	31,8	45	12	330	3,72
45 L 100	2F	St	45	136,44	135,67	143	70	31,8	45	12	331	3,89
48 L 100	2F	St	48	145,53	144,77	152	70	31,8	45	12	334	4,38
50 L 100	4	GG	50	151,60	150,83		70	31,8	45	14		2,41
52 L 100	4	GG	52	157,66	156,90		70	31,8	45	14		2,55
56 L 100	4	GG	56	169,79	169,02		70	31,8	45	14		2,65
57 L 100	4	GG	57	172,82	172,06		70	31,8	45	14		2,71
60 L 100	4	GG	60	181,91	181,15		75	31,8	45	14		3,11
72 L 100	4	GG	72	218,29	217,53		75	31,8	45	14		3,65
84 L 100	4	GG	84	254,68	253,92		75	31,8	45	14		4,12
96 L 100	4	GG	96	291,06	290,30		75	31,8	45	14		4,60

PULEGGE DENTATE PER CINGHIE POSITIVE SYNCHROBELT® - ISO 5294

TIMING BELT PULLEYS - ISO 5294

H 075

PASSO 1/2" (12,7 mm)

PER CINGHIE LARGHEZZA 3/4" (19,05 mm)

Materiale: Acciaio (St)
Materiale: Ghisa (GG)

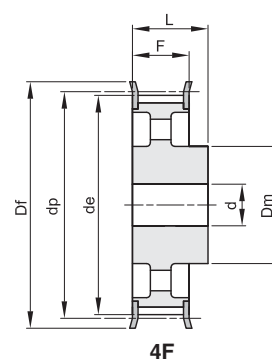
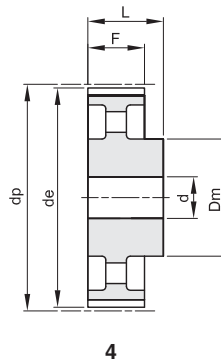
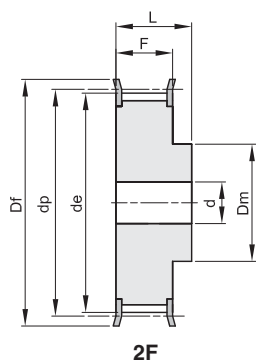

codice	tipo	materiale	denti	dp	de	Df	Dm	F	L	d	n° flangia	Kg.
14 H 075	2F	St	14	56,59	55,22	63	40	26,4	40	10	309	0,58
15 H 075	2F	St	15	60,64	59,27	66	45	26,4	40	10	310	0,69
16 H 075	2F	St	16	64,68	63,31	71	45	26,4	40	10	311	0,77
17 H 075	2F	St	17	68,72	67,35	75	45	26,4	40	12	312	0,84
18 H 075	2F	St	18	72,77	71,39	79	55	26,4	40	12	313	1,01
19 H 075	2F	St	19	76,81	75,44	83	60	26,4	40	12	314	1,15
20 H 075	2F	St	20	80,85	79,48	87	62	26,4	40	12	315	1,27
21 H 075	2F	St	21	84,89	83,52	91	65	26,4	40	12	316	1,41
22 H 075	2F	St	22	88,94	87,56	93	68	26,4	40	12	317	1,55
23 H 075	2F	St	23	92,98	91,61	97	72	26,4	40	12	318	1,71
24 H 075	2F	St	24	97,03	95,65	103	72	26,4	40	12	320	1,83
25 H 075	2F	St	25	101,06	99,69	106	72	26,4	40	12	321	1,96
26 H 075	2F	St	26	105,11	103,73	111	80	26,4	40	12	322	2,19
27 H 075	2F	St	27	109,15	107,78	115	80	26,4	40	12	323	2,32
28 H 075	2F	St	28	113,19	111,82	119	80	26,4	40	12	325	2,47
30 H 075	2F	St	30	121,29	119,90	127	80	26,4	40	14	327	2,76
32 H 075	2F	St	32	129,36	127,99	135	80	26,4	40	14	328	3,08
33 H 075	2F	St	33	133,40	132,03	140	80	26,4	40	14	330	3,25
34 H 075	2F	St	34	137,45	136,07	143	80	26,4	40	14	331	3,42
35 H 075	2F	St	35	141,49	140,12	148	80	26,4	40	14	333	3,61
36 H 075	2F	St	36	145,53	144,16	152	80	26,4	40	14	334	3,79
38 H 075	2F	St	38	153,62	152,24	158	80	26,4	40	14	335	4,16
40 H 075	2F	St	40	161,70	160,33	168	80	26,4	40	14	338	4,58
44 H 075	4F	GG	44	177,87	176,50	184	80	26,4	40	18	339	2,57
48 H 075	4F	GG	48	194,04	192,67	200	90	26,4	45	18	342	3,56
50 H 075	4	GG	50	202,13	200,75		90	26,4	45	18		3,74

PULEGGE DENTATE PER CINGHIE POSITIVE SYNCHROBELT® - ISO 5294

TIMING BELT PULLEYS - ISO 5294

H 100

PASSO 1/2" (12,7 mm)
PER CINGHIE LARGHEZZA 1" (25,4 mm)

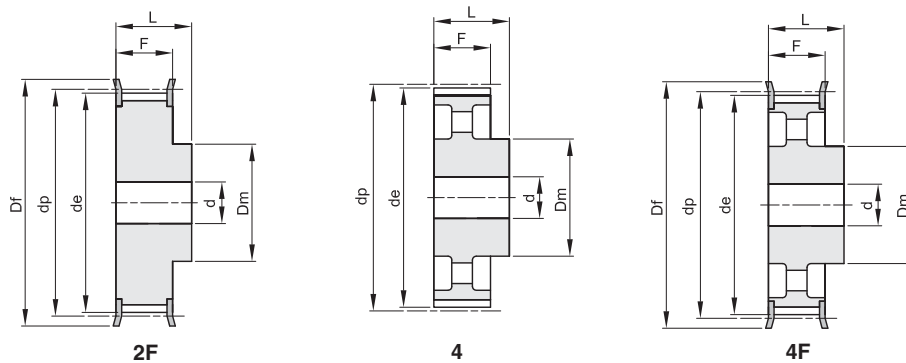

Materiale: Acciaio (St)
 Materiale: Ghisa (GG)

codice	tipo	materiale	dent	dp	de	Df	Dm	F	L	d	n° flangia	Kg.
14 H 100	2F	St	14	56,59	55,22	63	40	31,8	45	12	309	0,65
15 H 100	2F	St	15	60,64	59,27	66	45	31,8	45	12	310	0,77
16 H 100	2F	St	16	64,68	63,31	71	45	31,8	45	12	311	0,87
17 H 100	2F	St	17	68,72	67,35	75	45	31,8	45	12	312	0,97
18 H 100	2F	St	18	72,77	71,39	79	55	31,8	45	12	313	1,16
19 H 100	2F	St	19	76,81	75,44	83	60	31,8	45	14	314	1,30
20 H 100	2F	St	20	80,85	79,48	87	62	31,8	45	14	315	1,44
21 H 100	2F	St	21	84,89	83,52	91	65	31,8	45	14	316	1,60
22 H 100	2F	St	22	88,94	87,56	93	68	31,8	45	14	317	1,76
23 H 100	2F	St	23	92,98	91,61	97	72	31,8	45	14	318	1,94
24 H 100	2F	St	24	97,03	95,65	103	72	31,8	45	14	320	2,09
25 H 100	2F	St	25	101,06	99,69	106	72	31,8	45	14	321	2,24
26 H 100	2F	St	26	105,11	103,73	111	80	31,8	45	14	322	2,49
27 H 100	2F	St	27	109,15	107,78	115	80	31,8	45	14	323	2,66
28 H 100	2F	St	28	113,19	111,82	119	80	31,8	45	14	325	2,83
29 H 100	2F	St	29	117,23	115,86	123	80	31,8	45	14	326	3,01
30 H 100	2F	St	30	121,29	119,90	127	80	31,8	45	14	327	3,19
32 H 100	2F	St	32	129,36	127,99	135	80	31,8	45	14	328	3,57
33 H 100	2F	St	33	133,40	132,03	140	80	31,8	45	14	330	3,79
34 H 100	2F	St	34	137,45	136,07	143	80	31,8	45	14	331	3,99
35 H 100	2F	St	35	141,49	140,12	148	80	31,8	45	14	333	4,20
36 H 100	2F	St	36	145,53	144,16	152	80	31,8	45	14	334	4,44
38 H 100	2F	St	38	153,62	152,24	158	80	31,8	45	14	335	4,90
40 H 100	2F	St	40	161,70	160,33	168	80	31,8	45	14	338	5,39
44 H 100	4F	GG	44	177,87	176,50	184	80	31,8	50	18	339	3,37
45 H 100	4F	GG	45	181,91	180,54	192	80	31,8	50	18	340	3,57
48 H 100	4F	GG	48	194,04	192,67	200	90	31,8	50	18	342	4,10
50 H 100	4	GG	50	202,13	200,75		90	31,8	50	18		4,24
52 H 100	4	GG	52	210,21	208,84		90	31,8	50	18		4,32
58 H 100	4	GG	58	234,47	233,09		90	31,8	50	18		4,61
60 H 100	4	GG	60	242,55	241,18		100	31,8	50	18		5,30
70 H 100	4	GG	70	282,98	281,61		100	31,8	55	18		6,13
72 H 100	4	GG	72	291,06	289,69		120	31,8	55	18		7,47
84 H 100	4	GG	84	339,57	338,20		120	31,8	55	18		8,52
96 H 100	4	GG	96	388,08	386,71		120	31,8	60	18		10,25
120 H 100	4	GG	120	485,10	483,73		120	31,8	60	18		13,09

PULEGGE DENTATE PER CINGHIE POSITIVE SYNCHROBELT® - ISO 5294

TIMING BELT PULLEYS - ISO 5294

H 150

PASSO 1/2" (12,7 mm)

PER CINGHIE LARGHEZZA 1 1/2 (38,1 mm)

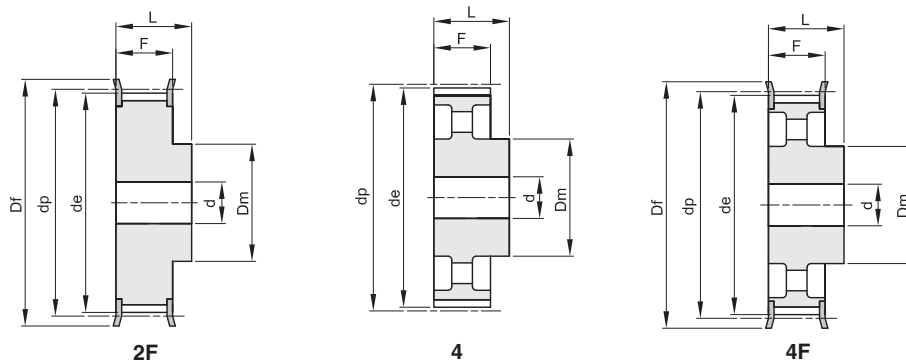

Materiale: Acciaio (St)
Materiale: Ghisa (GG)

codice	tipo	materiale	denti	dp	de	Df	Dm	F	L	d	n° flangia	Kg.
14 H 150	2F	St	14	56,59	55,22	63	40	46,0	58	18	309	0,81
15 H 150	2F	St	15	60,64	59,27	66	45	46,0	58	18	310	0,97
16 H 150	2F	St	16	64,68	63,31	71	45	46,0	58	18	311	1,11
17 H 150	2F	St	17	68,72	67,35	75	45	46,0	58	18	312	1,25
18 H 150	2F	St	18	72,77	71,39	79	55	46,0	58	18	313	1,48
19 H 150	2F	St	19	76,81	75,44	83	60	46,0	58	18	314	1,68
20 H 150	2F	St	20	80,85	79,48	87	62	46,0	58	18	315	1,88
21 H 150	2F	St	21	84,89	83,52	91	65	46,0	58	18	316	2,08
22 H 150	2F	St	22	88,94	87,56	93	68	46,0	58	18	317	2,30
23 H 150	2F	St	23	92,98	91,61	97	72	46,0	58	18	318	2,54
24 H 150	2F	St	24	97,03	95,65	103	72	46,0	58	18	320	2,75
25 H 150	2F	St	25	101,06	99,69	106	72	46,0	58	18	321	2,97
26 H 150	2F	St	26	105,11	103,73	111	80	46,0	58	18	322	3,29
27 H 150	2F	St	27	109,15	107,78	115	80	46,0	58	18	323	3,52
28 H 150	2F	St	28	113,19	111,82	119	80	46,0	58	18	325	3,78
29 H 150	2F	St	29	117,23	115,86	123	80	46,0	58	18	326	4,03
30 H 150	2F	St	30	121,29	119,90	127	80	46,0	58	18	327	4,29
32 H 150	2F	St	32	129,36	127,99	135	80	46,0	58	18	328	4,86
33 H 150	2F	St	33	133,40	132,03	140	80	46,0	58	18	330	5,15
34 H 150	2F	St	34	137,45	136,07	143	80	46,0	58	18	331	5,46
35 H 150	2F	St	35	141,49	140,12	148	80	46,0	58	18	333	5,78
36 H 150	2F	St	36	145,53	144,16	152	80	46,0	58	18	334	6,09
38 H 150	2F	St	38	153,62	152,24	158	80	46,0	58	18	335	6,74
40 H 150	2F	St	40	161,70	160,33	168	80	46,0	58	18	338	7,46
44 H 150	4F	GG	44	177,87	176,50	184	80	46,0	58	18	339	4,29
45 H 150	4F	GG	45	181,91	180,54	192	80	46,0	58	18	340	4,44
48 H 150	4F	GG	48	194,04	192,67	200	90	46,0	65	18	342	5,41
50 H 150	4	GG	50	202,13	200,75		90	46,0	65	18		5,59
52 H 150	4	GG	52	210,21	208,84		90	46,0	65	18		5,79
58 H 150	4	GG	58	234,47	233,09		90	46,0	65	18		6,15
60 H 150	4	GG	60	242,55	241,18		100	46,0	65	18		7,08
70 H 150	4	GG	70	282,98	281,61		100	46,0	65	24		7,77
72 H 150	4	GG	72	291,06	289,69		120	46,0	65	24		9,70
84 H 150	4	GG	84	339,57	338,20		120	46,0	65	24		10,99
96 H 150	4	GG	96	388,08	386,71		120	46,0	65	24		12,24
120 H 150	4	GG	120	485,10	483,73		120	46,0	65	24		16,17

PULEGGE DENTATE PER CINGHIE POSITIVE SYNCHROBELT® - ISO 5294

TIMING BELT PULLEYS - ISO 5294

H 200
PASSO 1/2" (12,7 mm)
PER CINGHIE LARGHEZZA 2" (50,8 mm)

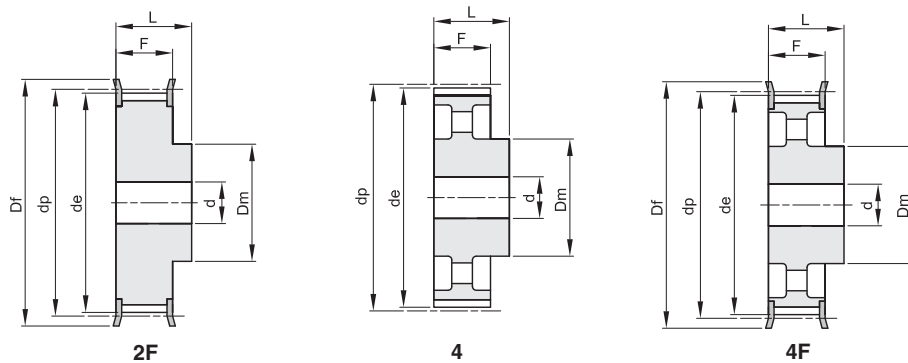

Materiale: Acciaio (St)
 Materiale: Ghisa (GG)

codice	tipo	materiale	dent	dp	de	Df	Dm	F	L	d	n° flangia	Kg.
14 H 200	2F	St	14	56,59	55,22	63	40	58,7	70	18	309	1,10
15 H 200	2F	St	15	60,64	59,27	66	45	58,7	70	18	310	1,33
16 H 200	2F	St	16	64,68	63,31	71	45	58,7	70	18	311	1,54
17 H 200	2F	St	17	68,72	67,35	75	45	58,7	70	18	312	1,69
18 H 200	2F	St	18	72,77	71,39	79	55	58,7	70	18	313	1,95
19 H 200	2F	St	19	76,81	75,44	83	60	58,7	70	18	314	2,20
20 H 200	2F	St	20	80,85	79,48	87	62	58,7	70	18	315	2,44
21 H 200	2F	St	21	84,89	83,52	91	65	58,7	70	18	316	2,70
22 H 200	2F	St	22	88,94	87,56	93	68	58,7	70	18	317	2,97
23 H 200	2F	St	23	92,98	91,61	97	72	58,7	70	18	318	3,25
24 H 200	2F	St	24	97,03	95,65	103	72	58,7	70	18	320	3,56
25 H 200	2F	St	25	101,06	99,69	106	72	58,7	70	18	321	3,81
26 H 200	2F	St	26	105,11	103,73	111	80	58,7	70	18	322	4,18
27 H 200	2F	St	27	109,15	107,78	115	80	58,7	70	18	323	4,49
28 H 200	2F	St	28	113,19	111,82	119	80	58,7	70	18	325	4,81
29 H 200	2F	St	29	117,23	115,86	123	80	58,7	70	18	326	5,14
30 H 200	2F	St	30	121,29	119,90	127	80	58,7	70	18	327	5,47
32 H 200	2F	St	32	129,36	127,99	135	80	58,7	70	18	328	6,17
33 H 200	2F	St	33	133,40	132,03	140	80	58,7	70	18	330	6,56
34 H 200	2F	St	34	137,45	136,07	143	80	58,7	70	18	331	6,94
35 H 200	2F	St	35	141,49	140,12	148	80	58,7	70	18	333	7,34
36 H 200	2F	St	36	145,53	144,16	152	80	58,7	70	18	334	7,75
38 H 200	2F	St	38	153,62	152,24	158	80	58,7	70	18	335	8,62
40 H 200	2F	St	40	161,70	160,33	168	80	58,7	70	18	338	9,50
44 H 200	4F	GG	44	177,87	176,50	184	80	58,7	70	18	339	5,14
45 H 200	4F	GG	45	181,91	180,54	192	80	58,7	70	18	340	5,38
48 H 200	4F	GG	48	194,04	192,67	200	90	58,7	75	24	342	6,29
50 H 200	4	GG	50	202,13	200,75		90	58,7	75	24		6,68
52 H 200	4	GG	52	210,21	208,84		90	58,7	75	24		6,81
58 H 200	4	GG	58	234,47	233,09		90	58,7	75	24		7,26
60 H 200	4	GG	60	242,55	241,18		100	58,7	75	24		8,25
70 H 200	4	GG	70	282,98	281,61		100	58,7	75	28		9,20
72 H 200	4	GG	72	291,06	289,69		120	58,7	75	28		11,09
84 H 200	4	GG	84	339,57	338,20		120	58,7	75	28		12,63
96 H 200	4	GG	96	388,08	386,71		120	58,7	75	28		14,51
120 H 200	4	GG	120	485,10	483,73		120	58,7	75	28		19,15

PULEGGE DENTATE PER CINGHIE POSITIVE SYNCHROBELT® - ISO 5294

TIMING BELT PULLEYS - ISO 5294

H 300

PASSO 1/2" (12,7 mm)

PER CINGHIE LARGHEZZA 3" (76,2 mm)

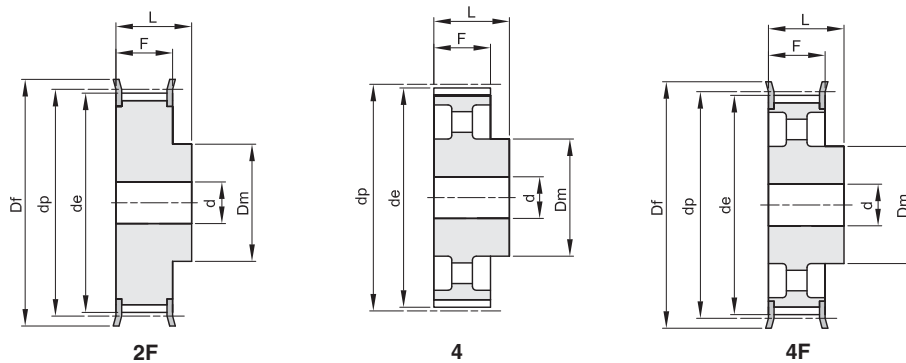

Materiale: Acciaio (St)
Materiale: Ghisa (GG)

codice	tipo	materiale	denti	dp	de	Df	Dm	F	L	d	n° flangia	Kg.
14 H 300	2F	St	14	56,59	55,22	63	40	85,7	100	18	309	1,64
15 H 300	2F	St	15	60,64	59,27	66	45	85,7	100	18	310	1,91
16 H 300	2F	St	16	64,68	63,31	71	45	85,7	100	18	311	2,16
17 H 300	2F	St	17	68,72	67,35	75	45	85,7	100	18	312	2,43
18 H 300	2F	St	18	72,77	71,39	79	55	85,7	100	18	313	2,80
19 H 300	2F	St	19	76,81	75,44	83	60	85,7	100	18	314	3,16
20 H 300	2F	St	20	80,85	79,48	87	62	85,7	100	18	315	3,50
21 H 300	2F	St	21	84,89	83,52	91	65	85,7	100	18	316	3,87
22 H 300	2F	St	22	88,94	87,56	93	68	85,7	100	18	317	4,26
23 H 300	2F	St	23	92,98	91,61	97	72	85,7	100	18	318	4,68
24 H 300	2F	St	24	97,03	95,65	103	72	85,7	100	18	320	5,08
25 H 300	2F	St	25	101,06	99,69	106	72	85,7	100	18	321	5,45
26 H 300	2F	St	26	105,11	103,73	111	80	85,7	100	18	322	6,01
27 H 300	2F	St	27	109,15	107,78	115	80	85,7	100	18	323	6,45
28 H 300	2F	St	28	113,19	111,82	119	80	85,7	100	18	325	6,91
30 H 300	2F	St	30	121,29	119,90	127	80	85,7	100	18	327	7,90
32 H 300	2F	St	32	129,36	127,99	135	80	85,7	100	18	328	8,92
33 H 300	2F	St	33	133,40	132,03	140	80	85,7	100	18	330	9,46
34 H 300	2F	St	34	137,45	136,07	143	80	85,7	100	18	331	10,04
35 H 300	2F	St	35	141,49	140,12	148	80	85,7	100	18	333	10,62
36 H 300	2F	St	36	145,53	144,16	152	80	85,7	100	18	334	11,24
38 H 300	2F	St	38	153,62	152,24	158	80	85,7	100	18	335	12,44
40 H 300	2F	St	40	161,70	160,33	168	80	85,7	100	18	338	13,80
44 H 300	4F	GG	44	177,87	176,50	184	80	85,7	100	24	339	7,22
48 H 300	4F	GG	48	194,04	192,67	200	90	85,7	100	24	342	8,60
50 H 300	4	GG	50	202,13	200,75		90	85,7	100	24		8,99
58 H 300	4	GG	58	234,47	233,09		90	85,7	100	24		10,04
60 H 300	4	GG	60	242,55	241,18		100	85,7	100	24		11,18
72 H 300	4	GG	72	291,06	289,69		120	85,7	100	28		15,07
84 H 300	4	GG	84	339,57	338,20		120	85,7	100	28		16,97
96 H 300	4	GG	96	388,08	386,71		120	85,7	100	28		19,86
120 H 300	4	GG	120	485,10	483,73		120	85,7	100	28		25,91

PULEGGE DENTATE PER CINGHIE POSITIVE SYNCHROBELT® - ISO 5294

TIMING BELT PULLEYS - ISO 5294

XH 200

PASSO 7/8" (22,22 mm)
PER CINGHIE LARGHEZZA 2" (50,8 mm)

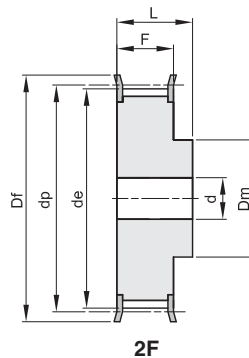

Materiale: Acciaio (St)

codice	tipo	materiale	denti	dp	de	Df	Dm	F	L	d	n° flangia	Kg.
18 XH 200	2F	St	18	127,34	124,55	138	100	65	80	24	401	6,00
19 XH 200	2F	St	19	134,41	131,62	146	100	65	80	24	402	6,60
20 XH 200	2F	St	20	141,49	138,69	154	100	65	80	24	403	7,30
21 XH 200	2F	St	21	148,56	145,77	160	110	65	80	24	404	8,73
22 XH 200	2F	St	22	155,64	152,84	168	110	65	80	24	405	9,55
24 XH 200	2F	St	24	169,79	166,99	183	120	65	80	24	406	11,47
25 XH 200	2F	St	25	176,86	174,07	188	120	65	80	24	407	12,46
26 XH 200	2F	St	26	183,93	181,14	198	120	65	80	24	409	13,47
27 XH 200	2F	St	27	191,01	188,22	200	120	65	80	24	410	14,42
28 XH 200	2F	St	28	198,09	195,29	211	120	65	80	24	411	15,44
30 XH 200	2F	St	30	212,23	209,44	226	120	65	80	24	412	17,69
32 XH 200	2F	St	32	226,38	223,59	240	120	65	80	24	414	19,95
34 XH 200	2F	St	34	240,53	237,74	256	120	65	80	24	415	22,75

PULEGGE DENTATE PER CINGHIE POSITIVE SYNCHROBELT® - ISO 5294

TIMING BELT PULLEYS - ISO 5294

XH 300

PASSO 7/8" (22,22 mm)
PER CINGHIE LARGHEZZA 3" (76,2 mm)

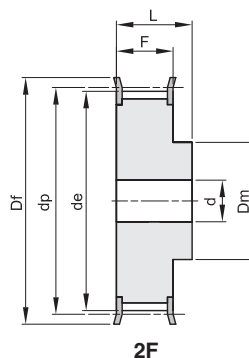

Materiale: Acciaio (St)

codice	tipo	materiale	denti	dp	de	Df	Dm	F	L	d	n° flangia	Kg.
18 XH 300	2F	St	18	127,34	124,55	138	100	92	110	28	401	8,90
19 XH 300	2F	St	19	134,41	131,62	146	100	92	110	28	402	9,20
20 XH 300	2F	St	20	141,49	138,69	154	100	92	110	28	403	10,61
21 XH 300	2F	St	21	148,56	145,77	160	110	92	110	28	404	11,87
22 XH 300	2F	St	22	155,64	152,84	168	110	92	110	28	405	13,08
24 XH 300	2F	St	24	169,79	166,99	183	120	92	110	28	406	15,77
25 XH 300	2F	St	25	176,86	174,07	188	120	92	110	28	407	17,13
26 XH 300	2F	St	26	183,93	181,14	198	120	92	110	28	409	18,55
27 XH 300	2F	St	27	191,01	188,22	200	120	92	110	28	410	19,90
28 XH 300	2F	St	28	198,09	195,29	211	150	92	110	28	411	22,27
30 XH 300	2F	St	30	212,23	209,44	226	150	92	110	28	412	25,39
32 XH 300	2F	St	32	226,38	223,59	240	150	92	110	28	414	28,73
34 XH 300	2F	St	34	240,53	237,74	256	150	92	110	28	415	34,20

PULEGGE DENTATE PER CINGHIE POSITIVE SYNCHROBELT® - ISO 5294

TIMING BELT PULLEYS - ISO 5294

XH 400

PASSO 7/8" (22,22 mm)
PER CINGHIE LARGHEZZA 4" (101,6 mm)

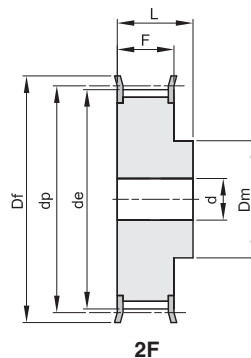

Materiale: Acciaio (St)

codice	tipo	materiale	denti	dp	de	Df	Dm	F	L	d	n° flangia	Kg.
18 XH 400	2F	St	18	127,34	124,55	138	100	119	132	32	401	9,60
19 XH 400	2F	St	19	134,41	131,62	146	100	119	132	32	402	10,80
20 XH 400	2F	St	20	141,49	138,69	154	100	119	132	32	403	12,87
21 XH 400	2F	St	21	148,56	145,77	160	110	119	132	32	404	14,42
22 XH 400	2F	St	22	155,64	152,84	168	110	119	132	32	405	15,44
24 XH 400	2F	St	24	169,79	166,99	183	120	119	132	32	406	19,22
25 XH 400	2F	St	25	176,86	174,07	188	120	119	132	32	407	21,05
26 XH 400	2F	St	26	183,93	181,14	198	120	119	132	32	409	22,80
27 XH 400	2F	St	27	191,01	188,22	200	120	119	132	32	410	24,66
28 XH 400	2F	St	28	198,09	195,29	211	150	119	132	32	411	27,23
30 XH 400	2F	St	30	212,23	209,44	226	150	119	132	32	412	31,30
32 XH 400	2F	St	32	226,38	223,59	240	150	119	132	32	414	35,20
34 XH 400	2F	St	34	240,53	237,74	256	150	119	132	32	415	40,00

PULEGGE DENTATE A BUSSOLA CONICA PER CINGHIE POSITIVE SYNCHROBELT® - ISO 5294
TIMING BELT PULLEYS FOR TAPER BUSHES - ISO 5294

L 050

PASSO 3/8" (9,525 mm)
PER CINGHIE LARGHEZZA 1/2" (12,7 mm)

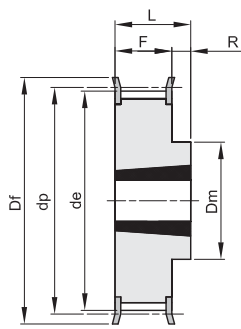

10F

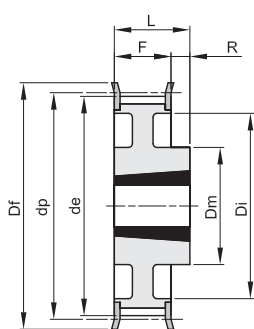

11F

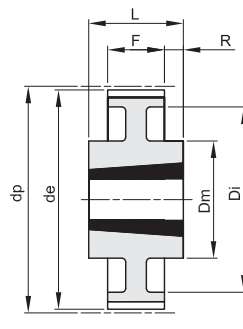

13

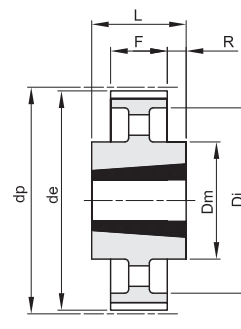

14

Materiale: Acciaio (St)
 Materiale: Ghisa (GG)

codice	tipo	materiale	denti	bussola	foro max	dp	de	Df	Dm	Di	F	L	R	n° flangia	Kg.
TL 18 L 050	10F	St	18	1108	28	54,57	53,81	60	45		19,0	22,0	3	308	0,20
TL 19 L 050	10F	St	19	1108	28	57,61	56,84	63	45		19,0	22,0	3	309	0,23
TL 20 L 050	10F	St	20	1108	28	60,64	59,88	66	48		19,0	22,0	3	310	0,27
TL 21 L 050	10F	St	21	1108	28	63,67	62,91	71	48		19,0	22,0	3	311	0,30
TL 22 L 050	10F	St	22	1108	28	66,70	65,94	75	51		19,0	22,0	3	312	0,34
TL 23 L 050	10F	St	23	1108	28	69,73	68,97	79	54		19,0	22,0	3	313	0,40
TL 24 L 050	10F	St	24	1108	28	72,77	72,00	79	54		19,0	22,0	3	313	0,45
TL 25 L 050	10F	St	25	1108	28	75,80	75,04	83	56		19,0	22,0	3	314	0,50
TL 26 L 050	10F	St	26	1108	28	78,83	78,07	87	60		19,0	22,0	3	315	0,55
TL 27 L 050	10F	St	27	1108	28	81,86	81,10	87	62		19,0	22,0	3	315	0,60
TL 28 L 050	10F	St	28	1108	28	84,89	84,13	91	65		19,0	22,0	3	316	0,65
TL 30 L 050	10F	St	30	1108	28	90,96	90,20	97	70		19,0	22,0	3	318	0,80
TL 32 L 050	10F	St	32	1108	28	97,02	96,26	103	74		19,0	22,0	3	320	0,98
TL 36 L 050	10F	St	36	1108	28	109,15	108,39	115	85		19,0	22,0	3	323	1,20
TL 40 L 050	10F	St	40	1610	42	121,28	120,51	127	97		19,0	25,0	6	327	1,40
TL 48 L 050	11F	St	48	1610	42	145,53	144,77	152	88	120	19,0	25,0	6	334	2,30
TL 60 L 050	13	St	60	1610	42	181,91	181,15		92	166	19,0	25,0	3		2,20
TL 72 L 050	14	GG	72	1610	42	218,30	217,53		92	202	19,0	25,0	3		2,10
TL 84 L 050	14	GG	84	1610	42	254,68	253,90		92	236	19,0	25,0	3		2,46
TL 96 L 050	14	GG	96	2012	50	291,06	290,30		106	270	19,0	32,0	6,5		3,36
TL120 L 050	14	GG	120	2012	50	363,83	363,07		106	343	19,0	32,0	6,5		4,44

PULEGGE DENTATE A BUSSOLA CONICA PER CINGHIE POSITIVE SYNCHROBELT® - ISO 5294
TIMING BELT PULLEYS FOR TAPER BUSHES - ISO 5294

L 075

PASSO 3/8" (9,525 mm)

PER CINGHIE LARGHEZZA 3/4" (19,05 mm)

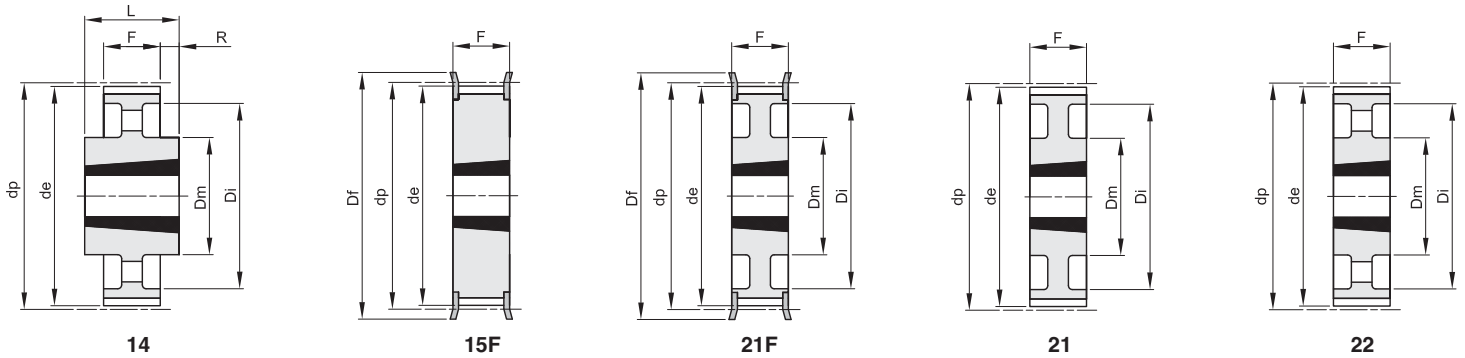

Materiale: Acciaio (St)
Materiale: Ghisa (GG)

codice	tipo	materiale	denti	bussola	foro max	dp	de	Df	Dm	Di	F	L	R	n° flangia	Kg.
TL 18 L 075	15F	St	18	1108	28	54,57	53,81	60			25,0	25,0		308	0,25
TL 19 L 075	15F	St	19	1108	28	57,61	56,84	63			25,0	25,0		309	0,32
TL 20 L 075	15F	St	20	1108	28	60,64	59,88	66			25,0	25,0		310	0,35
TL 21 L 075	15F	St	21	1108	28	63,67	62,91	71			25,0	25,0		311	0,40
TL 22 L 075	15F	St	22	1108	28	66,70	65,94	75			25,0	25,0		312	0,44
TL 23 L 075	15F	St	23	1108	28	69,73	68,97	79			25,0	25,0		313	0,48
TL 24 L 075	15F	St	24	1108	28	72,77	72,00	79			25,0	25,0		313	0,55
TL 25 L 075	15F	St	25	1108	28	75,80	75,04	83			25,0	25,0		314	0,63
TL 26 L 075	15F	St	26	1108	28	78,83	78,07	87			25,0	25,0		315	0,66
TL 27 L 075	15F	St	27	1108	28	81,86	81,10	87			25,0	25,0		315	0,70
TL 28 L 075	15F	St	28	1108	28	84,89	84,13	91			25,0	25,0		316	0,72
TL 30 L 075	15F	St	30	1108	28	90,96	90,20	97			25,0	25,0		318	0,93
TL 32 L 075	15F	St	32	1108	28	97,02	96,26	103			25,0	25,0		320	1,10
TL 36 L 075	15F	St	36	1610	42	109,15	108,39	115			25,0	25,0		323	1,20
TL 40 L 075	15F	St	40	1610	42	121,28	120,51	127			25,0	25,0		327	1,70
TL 48 L 075	21F	St	48	1610	42	145,53	144,77	152	92	120	25,0	25,0		334	2,60
TL 60 L 075	21	St	60	1610	42	181,91	181,15		92	166	25,0	25,0			3,00
TL 72 L 075	22	GG	72	1610	42	218,30	217,53		92	202	25,0	25,0			2,33
TL 84 L 075	14	GG	84	2012	50	254,68	253,90		106	236	25,0	32,0	3,5		3,55
TL 96 L 075	14	GG	96	2012	50	291,06	290,30		106	270	25,0	32,0	3,5		3,95
TL120 L 075	14	GG	120	2012	50	363,83	363,07		106	343	25,0	32,0	3,5		5,61

PULEGGE DENTATE A BUSSOLA CONICA PER CINGHIE POSITIVE SYNCHROBELT® - ISO 5294
TIMING BELT PULLEYS FOR TAPER BUSHES - ISO 5294

L 100

PASSO 3/8" (9,525 mm)

PER CINGHIE LARGHEZZA 1" (25,4 mm)

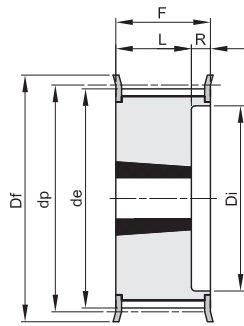

16F

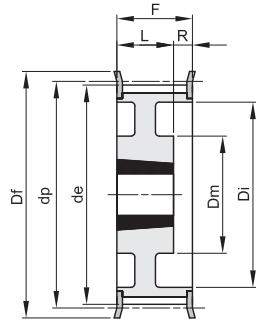

17F

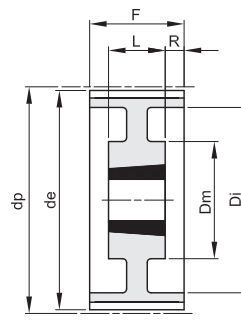

19

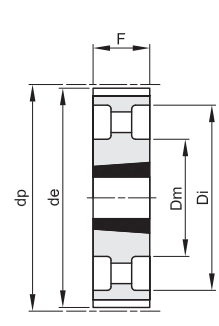

22

Materiale: Acciaio (St)
 Materiale: Ghisa (GG)

codice	tipo	materiale	denti	bussola	foro max	dp	de	Df	Dm	Di	F	L	R	n° flangia	Kg.
TL 18 L 100	16F	St	18	1108	28	54,57	53,81	60		38	31,0	22,0	9,0	308	0,20
TL 19 L 100	16F	St	19	1108	28	57,61	56,84	63		38	31,0	22,0	9,0	309	0,32
TL 20 L 100	16F	St	20	1108	28	60,64	59,88	66		45	31,0	22,0	9,0	310	0,41
TL 21 L 100	16F	St	21	1108	28	63,67	62,91	71		45	31,0	22,0	9,0	311	0,45
TL 22 L 100	16F	St	22	1108	28	66,70	65,94	75		48	31,0	22,0	9,0	312	0,47
TL 23 L 100	16F	St	23	1108	28	69,73	68,97	79		52	32,0	22,0	10,0	313	0,50
TL 24 L 100	16F	St	24	1108	28	72,77	72,00	79		52	32,0	22,0	10,0	313	0,64
TL 25 L 100	16F	St	25	1108	28	75,80	75,04	83		54	32,0	22,0	10,0	314	0,68
TL 26 L 100	16F	St	26	1108	28	78,83	78,07	87		60	32,0	22,0	10,0	315	0,70
TL 27 L 100	16F	St	27	1108	28	81,86	81,10	87		60	32,0	22,0	10,0	315	0,83
TL 28 L 100	16F	St	28	1108	28	84,89	84,13	91		65	32,0	22,0	10,0	316	0,85
TL 30 L 100	16F	St	30	1210	32	90,96	90,20	97		71	32,0	25,0	7,0	318	0,90
TL 32 L 100	16F	St	32	1210	32	97,02	96,26	103		75	32,0	25,0	7,0	320	1,05
TL 36 L 100	16F	St	36	1610	42	109,15	108,39	115		86	32,0	25,0	7,0	323	1,40
TL 40 L 100	16F	St	40	1610	42	121,28	120,51	127		96	32,0	25,0	7,0	327	1,65
TL 48 L 100	17F	St	48	1610	42	145,53	144,77	152	92	120	32,0	25,0	7,0	334	2,80
TL 60 L 100	19	St	60	1610	42	181,91	181,15		92	166	32,0	25,0	3,5		2,70
TL 72 L 100	22	GG	72	2012	50	218,30	217,53		106	202	32,0	32,0			2,96
TL 84 L 100	22	GG	84	2012	50	254,68	253,90		106	236	32,0	32,0			3,87
TL 96 L 100	22	GG	96	2012	50	291,06	290,30		106	270	32,0	32,0			4,64
TL120 L 100	22	GG	120	2012	50	363,83	363,07		106	343	32,0	32,0			6,37

H 100

PASSO 1/2" (12,7 mm)

PER CINGHIE LARGHEZZA 1" (25,4 mm)

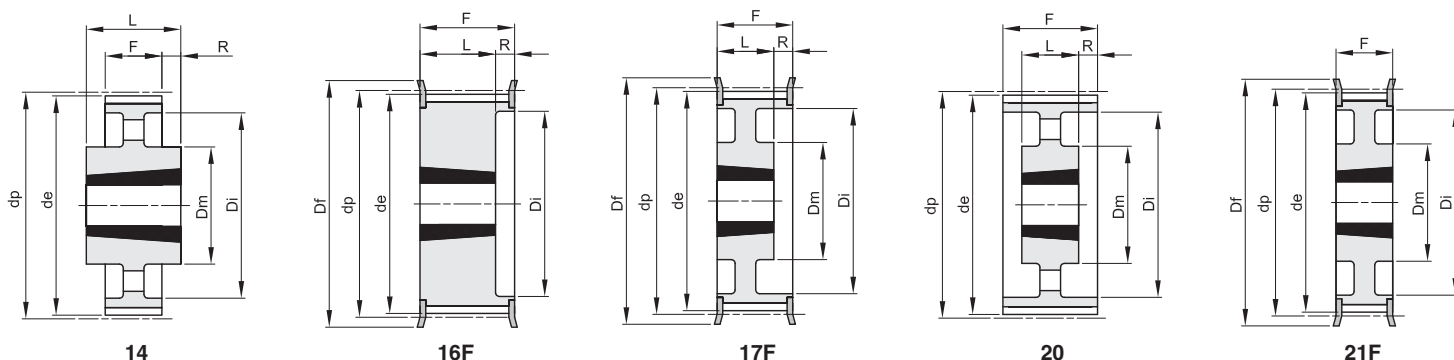

Materiale: Acciaio (St)
Materiale: Ghisa (GG)

codice	tipo	materiale	denti	bussola	foro max	dp	de	Df	Dm	Di	F	L	R	n° flangia	Kg.
TL 16 H 100	16F	St	16	1108	28	64,68	63,31	71		45	31,0	22,0	9,0	311	0,42
TL 18 H 100	16F	St	18	1210	32	72,77	71,39	79		52	31,0	25,0	6,0	313	0,49
TL 19 H 100	16F	St	19	1210	32	76,81	75,44	83		56	31,0	25,0	6,0	314	0,62
TL 20 H 100	16F	St	20	1210	32	80,85	79,48	87		60	31,0	25,0	6,0	315	0,73
TL 21 H 100	16F	St	21	1210	32	84,89	83,52	91		64	32,0	25,0	7,0	316	0,80
TL 22 H 100	16F	St	22	1210	32	88,94	87,56	93		67	32,0	25,0	7,0	317	0,94
TL 23 H 100	16F	St	23	1610	42	92,98	91,61	97		70	32,0	25,0	7,0	318	0,97
TL 24 H 100	16F	St	24	1610	42	97,02	95,65	103		73,5	32,0	25,0	7,0	320	1,05
TL 25 H 100	16F	St	25	1610	42	101,06	99,69	106		77	32,0	25,0	7,0	321	1,10
TL 26 H 100	16F	St	26	1610	42	105,11	103,73	111		82	32,0	25,0	7,0	322	1,20
TL 27 H 100	16F	St	27	1610	42	109,15	107,78	115		85	32,0	25,0	7,0	323	1,35
TL 28 H 100	16F	St	28	1610	42	113,19	111,82	119		90,5	32,0	25,0	7,0	325	1,50
TL 30 H 100	16F	St	30	1610	42	121,28	119,90	127		98	32,0	25,0	7,0	327	1,78
TL 32 H 100	17F	St	32	1610	42	129,36	127,99	135	90	106	32,0	25,0	7,0	328	2,05
TL 36 H 100	17F	St	36	1610	42	145,53	144,16	152	92	121	32,0	25,0	7,0	334	2,80
TL 40 H 100	17F	St	40	1610	42	161,70	160,33	168	92	138	32,0	25,0	7,0	338	3,65
TL 44 H 100	21F	St	44	2012	50	177,87	176,50	184	106	152	32,0	32,0		339	3,86
TL 48 H 100	21F	St	48	2012	50	194,04	192,67	200	106	169	32,0	32,0		342	4,20
TL 60 H 100	20	GG	60	2012	50	242,55	241,18		106	223	34,0	32,0	1,0		3,76
TL 72 H 100	20	GG	72	2012	50	291,06	289,69		106	270	34,0	32,0	1,0		4,88
TL 84 H 100	20	GG	84	2012	50	339,57	338,20		106	318	34,0	32,0	1,0		6,12
TL 96 H 100	14	GG	96	2517	60	388,08	386,71		119	366	34,0	45,0	5,5		7,95
TL120H 100	14	GG	120	2517	60	485,10	483,73		119	462	34,0	45,0	5,5		10,05

H 150

PASSO 1/2" (12,7 mm)

PER CINGHIE LARGHEZZA 1"1/2 (38,1 mm)

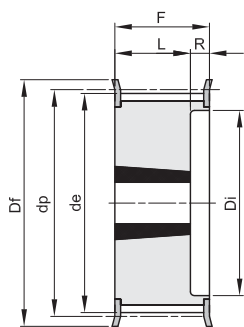

16F

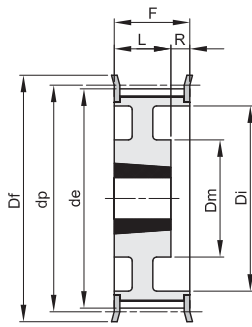

17F

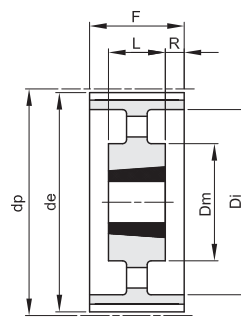

20

Materiale: Acciaio (St)

Materiale: Ghisa (GG)

codice	tipo	materiale	denti	bussola	foro max	dp	de	Df	Dm	Di	F	L	R	n° flangia	Kg.
TL 18 H 150	16F	St	18	1210	32	72,77	71,39	79		52	45,0	25,0	20,0	313	0,60
TL 19 H 150	16F	St	19	1210	32	76,81	75,44	83		56	45,0	25,0	20,0	314	0,72
TL 20 H 150	16F	St	20	1210	32	80,85	79,48	87		60	45,0	25,0	20,0	315	0,83
TL 21 H 150	16F	St	21	1210	32	84,89	83,52	91		64	45,0	25,0	20,0	316	1,00
TL 22 H 150	16F	St	22	1210	32	88,94	87,56	93		67	45,0	25,0	20,0	317	1,25
TL 23 H 150	16F	St	23	1610	42	92,98	91,61	97		70	45,0	25,0	20,0	318	1,05
TL 24 H 150	16F	St	24	1610	42	97,02	95,65	103		73,5	45,0	25,0	20,0	320	1,10
TL 25 H 150	16F	St	25	1610	42	101,06	99,69	106		77	45,0	25,0	20,0	321	1,30
TL 26 H 150	16F	St	26	1610	42	105,11	103,73	111		82	45,0	25,0	20,0	322	1,42
TL 27 H 150	16F	St	27	1610	42	109,15	107,78	115		85	45,0	25,0	20,0	323	1,65
TL 28 H 150	16F	St	28	1610	42	113,19	111,82	119		90,5	45,0	25,0	20,0	325	1,88
TL 30 H 150	16F	St	30	1610	42	121,28	119,90	127		98	45,0	25,0	20,0	327	2,05
TL 32 H 150	17F	St	32	1610	42	129,36	127,99	135	90	106	45,0	25,0	20,0	328	2,35
TL 36 H 150	17F	St	36	1610	42	145,53	144,16	152	92	121	45,0	25,0	20,0	334	3,20
TL 40 H 150	17F	St	40	1610	42	161,70	160,33	168	92	138	45,0	25,0	20,0	338	4,10
TL 44 H 150	17F	St	44	2012	50	177,87	176,50	184	106	152	45,0	32,0	13,0	339	4,50
TL 48 H 150	17F	St	48	2012	50	194,04	192,67	200	106	169	45,0	32,0	13,0	342	4,80
TL 60 H 150	20	GG	60	2012	50	242,55	241,18		106	223	46,0	32,0	7,0		4,51
TL 72 H 150	20	GG	72	2012	50	291,06	289,69		106	270	46,0	32,0	7,0		6,16
TL 84 H 150	20	GG	84	2012	50	339,57	338,20		106	320	46,0	32,0	7,0		7,40
TL 96 H 150	20	GG	96	2517	60	388,08	386,71		119	366	46,0	45,0	0,5		9,87
TL120H 150	20	GG	120	2517	60	485,10	483,73		119	462	46,0	45,0	0,5		13,50

H 200

PASSO 1/2" (12,7 mm)

PER CINGHIE LARGHEZZA 2" (50,8 mm)

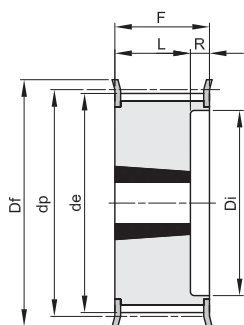

16F

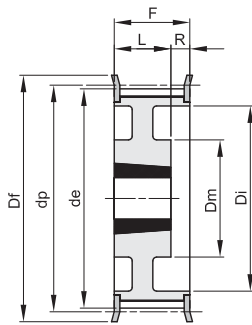

17F

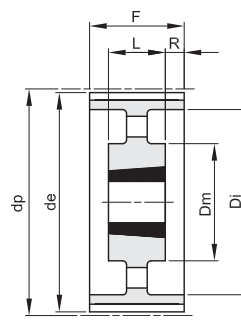

20

Materiale: Acciaio (St)

Materiale: Ghisa (GG)

codice	tipo	materiale	denti	bussola	foro max	dp	de	Df	Dm	Di	F	L	R	n° flangia	Kg.
TL 18 H 200	16F	St	18	1210	32	72,77	71,39	79		52	58,0	25,0	33,0	313	0,84
TL 19 H 200	16F	St	19	1210	32	76,81	75,44	83		56	58,0	25,0	33,0	314	0,96
TL 20 H 200	16F	St	20	1610	42	80,85	79,48	87		60	58,0	25,0	33,0	315	0,93
TL 21 H 200	16F	St	21	1610	42	84,89	83,52	91		64	58,0	25,0	33,0	316	1,07
TL 22 H 200	16F	St	22	1610	42	88,94	87,56	93		67	58,0	25,0	33,0	317	1,25
TL 23 H 200	16F	St	23	1610	42	92,98	91,61	97		70	58,0	25,0	33,0	318	1,40
TL 24 H 200	16F	St	24	1610	42	97,02	95,65	103		73,5	58,0	25,0	33,0	320	1,55
TL 25 H 200	16F	St	25	1610	42	101,06	99,69	106		77	58,0	25,0	33,0	321	1,71
TL 26 H 200	16F	St	26	1610	42	105,11	103,73	111		82	58,0	25,0	33,0	322	1,84
TL 27 H 200	16F	St	27	1610	42	109,15	107,78	115		85	58,0	25,0	33,0	323	2,06
TL 28 H 200	16F	St	28	1610	42	113,19	111,82	119		90,5	58,0	25,0	33,0	325	2,17
TL 30 H 200	16F	St	30	1610	42	121,28	119,90	127		98	58,0	25,0	33,0	327	2,60
TL 32 H 200	16F	St	32	2012	50	129,36	127,99	135		106	58,0	32,0	26,0	328	2,95
TL 36 H 200	17F	St	36	2012	50	145,53	144,16	152	102	121	58,0	32,0	26,0	334	3,62
TL 40 H 200	17F	St	40	2012	50	161,70	160,33	168	106	138	58,0	32,0	26,0	338	4,33
TL 44 H 200	17F	St	44	2012	50	177,87	176,50	184	106	152	58,0	32,0	26,0	339	5,33
TL 48 H 200	17F	St	48	2517	60	194,04	192,67	200	119	169	58,0	45,0	13,0	342	6,47
TL 60 H 200	20	GG	60	2517	60	242,55	241,18		119	223	60,0	45,0	7,5		5,86
TL 72 H 200	20	GG	72	2517	60	291,06	289,69		119	270	60,0	45,0	7,5		7,42
TL 84 H 200	20	GG	84	2517	60	339,57	338,20		119	320	60,0	45,0	7,5		8,73
TL 96 H 200	20	GG	96	2517	60	388,08	386,71		119	366	60,0	45,0	7,5		10,83
TL120H 200	20	GG	120	2517	60	485,10	483,73		119	462	60,0	45,0	7,5		14,95

PULEGGE DENTATE A BUSSOLA CONICA PER CINGHIE POSITIVE SYNCHROBELT® - ISO 5294
TIMING BELT PULLEYS FOR TAPER BUSHES - ISO 5294

H 300

PASSO 1/2" (12,7 mm)
PER CINGHIE LARGHEZZA 3" (76,2 mm)

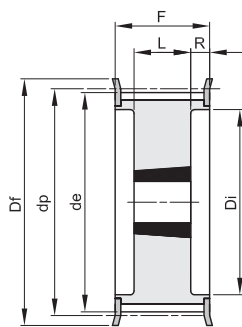

18F

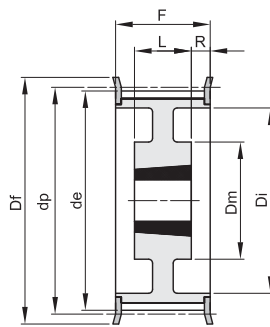

19F

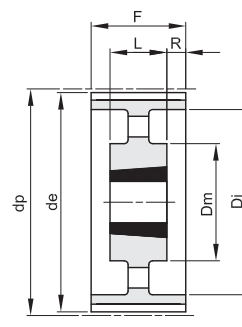

20

Materiale: Acciaio (St)
 Materiale: Ghisa (GG)

codice	tipo	materiale	denti	bussola	foro max	dp	de	Df	Dm	Di	F	L	R	n° flangia	Kg.
TL 20 H 300	18F	St	20	1615	42	80,85	79,48	87		64,5	84,0	38,0	23,0	315	1,22
TL 21 H 300	18F	St	21	1615	42	84,89	83,52	91		65	84,0	38,0	23,0	316	1,52
TL 22 H 300	18F	St	22	1615	42	88,94	87,56	93		67	84,0	38,0	23,0	317	1,80
TL 23 H 300	18F	St	23	1615	42	92,98	91,61	97		70	84,0	38,0	23,0	318	2,04
TL 24 H 300	18F	St	24	1615	42	97,02	95,65	103		73,5	84,0	38,0	23,0	320	2,29
TL 25 H 300	18F	St	25	1615	42	101,06	99,69	106		77	84,0	38,0	23,0	321	2,54
TL 26 H 300	18F	St	26	1615	42	105,11	103,73	111		82	84,0	38,0	23,0	322	2,73
TL 27 H 300	18F	St	27	2012	50	109,15	107,78	115		85	84,0	32,0	26,0	323	2,54
TL 28 H 300	18F	St	28	2012	50	113,19	111,82	119		90,5	84,0	32,0	26,0	325	2,68
TL 30 H 300	18F	St	30	2012	50	121,28	119,90	127		98	84,0	32,0	26,0	327	3,21
TL 32 H 300	18F	St	32	2517	60	129,36	127,99	135		106	84,0	45,0	19,5	328	3,58
TL 36 H 300	18F	St	36	2517	60	145,53	144,16	152		121	84,0	45,0	19,5	334	4,99
TL 40 H 300	18F	St	40	2517	60	161,70	160,33	168		138	84,0	45,0	19,5	338	6,50
TL 44 H 300	19F	St	44	2517	60	177,87	176,50	184	119	152	86,0	45,0	20,5	339	7,55
TL 48 H 300	19F	St	48	2517	60	194,04	192,67	200	119	169	86,0	45,0	20,5	342	8,66
TL 60 H 300	20	GG	60	2517	60	242,55	241,18		119	223	86,0	45,0	20,5		7,42
TL 72 H 300	20	GG	72	2517	60	291,06	289,69		119	270	86,0	45,0	20,5		9,33
TL 84 H 300	20	GG	84	2517	60	339,57	338,20		119	320	86,0	45,0	20,5		11,19
TL 96 H 300	20	GG	96	3030	75	388,08	386,71		150	362	86,0	76,0	5,0		17,96
TL120 H 300	20	GG	120	3030	75	485,10	483,73		150	460	86,0	76,0	5,0		22,23

PULEGGE DENTATE PER CINGHIE SYNCHROBELT® - “HTD” SYNCHROBELT® “HTD” TIMING BELT PULLEYS

3M

PASSO 3 mm

PER CINGHIE LARGHEZZA 9 mm

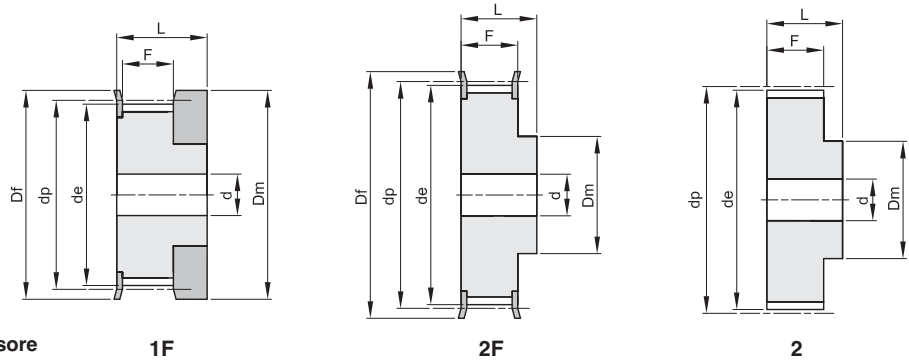

Materiale: Alluminio UNI 9006 - T6 (Al)
adatto per l'ossidazione dura a spessore

codice	tipo	materiale	denti	dp	de	Df	Dm	Di	F	L	d	n° flangia	Kg.
10 3M 09	1F	Al	10	9,55	8,79	13,0	12,0		10,2	17,5		100	0,01
12 3M 09	1F	Al	12	11,46	10,70	15,0	15,0		10,2	17,5		101	0,01
14 3M 09	1F	Al	14	13,37	12,61	16,0	16,0		10,2	17,5		102	0,01
15 3M 09	1F	Al	15	14,32	13,56	18,0	17,5		10,2	17,5		104	0,01
16 3M 09	2F	Al	16	15,28	14,52	18,0	10,0		12,8	20,6	4	104	0,01
18 3M 09	2F	Al	18	17,19	16,43	19,5	11,0		12,8	20,6	6	105	0,01
20 3M 09	2F	Al	20	19,10	18,34	23,0	13,0		12,8	20,6	6	107	0,01
21 3M 09	2F	Al	21	20,05	19,29	25,0	14,0		12,8	20,6	6	108	0,01
22 3M 09	2F	Al	22	21,01	20,25	25,0	14,0		12,8	20,6	6	108	0,01
24 3M 09	2F	Al	24	22,92	22,16	25,0	14,0		12,8	20,6	6	108	0,02
26 3M 09	2F	Al	26	24,83	24,07	28,0	16,0		12,8	20,6	6	109	0,02
28 3M 09	2F	Al	28	26,74	25,98	32,0	18,0		12,8	20,6	6	110	0,02
30 3M 09	2F	Al	30	28,65	27,89	32,0	20,0		12,8	20,6	6	110	0,03
32 3M 09	2F	Al	32	30,56	29,80	36,0	22,0		12,8	20,6	6	111	0,03
36 3M 09	2F	Al	36	34,38	33,62	38,0	26,0		13,4	22,2	6	112	0,05
40 3M 09	2F	Al	40	38,20	37,44	42,0	28,0		13,4	22,2	6	113	0,06
44 3M 09	2F	Al	44	42,02	41,26	48,0	33,0		13,4	22,2	6	114	0,07
48 3M 09	2	Al	48	45,84	45,08		33,0		13,4	22,2	8		0,11
60 3M 09	2	Al	60	57,30	56,54		33,0		13,4	22,2	8		0,11
72 3M 09	2	Al	72	68,76	68,00		33,0		13,4	22,2	8		0,15

PULEGGE DENTATE PER CINGHIE SYNCHROBELT® - "HTD" SYNCHROBELT® "HTD" TIMING BELT PULLEYS

3M

PASSO 3 mm

PER CINGHIE LARGHEZZA 15 mm

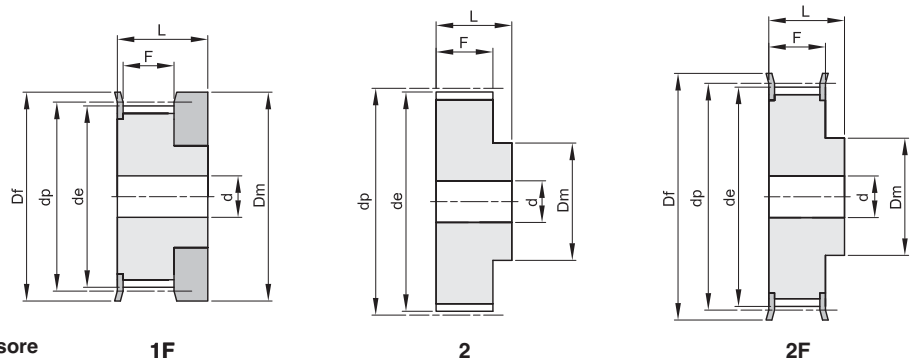

Materiale: Alluminio UNI 9006 - T6 (Al)
adatto per l'ossidazione dura a spessore

codice	tipo	materiale	denti	dp	de	Df	Dm	Di	F	L	d	n° flangia	Kg.
10 3M 15	1F	Al	10	9,55	8,79	13,0	12,0		17,0	26,0		100	0,01
12 3M 15	1F	Al	12	11,46	10,70	15,0	15,0		17,0	26,0		101	0,01
14 3M 15	1F	Al	14	13,37	12,61	16,0	16,0		17,0	26,0		102	0,01
15 3M 15	1F	Al	15	14,32	13,56	18,0	17,5		17,0	26,0		104	0,01
16 3M 15	2F	Al	16	15,28	14,52	18,0	10,0		19,5	26,0	4	104	0,01
18 3M 15	2F	Al	18	17,19	16,43	19,5	11,0		19,5	26,0	6	105	0,01
20 3M 15	2F	Al	20	19,10	18,34	23,0	13,0		19,5	26,0	6	107	0,01
21 3M 15	2F	Al	21	20,05	19,29	25,0	14,0		19,5	26,0	6	108	0,02
22 3M 15	2F	Al	22	21,01	20,25	25,0	14,0		19,5	26,0	6	108	0,02
24 3M 15	2F	Al	24	22,92	22,16	25,0	14,0		19,5	26,0	6	108	0,02
26 3M 15	2F	Al	26	24,83	24,07	28,0	16,0		19,5	26,0	6	109	0,03
28 3M 15	2F	Al	28	26,74	25,98	32,0	18,0		19,5	26,0	6	110	0,03
30 3M 15	2F	Al	30	28,65	27,89	32,0	20,0		19,5	26,0	6	110	0,04
32 3M 15	2F	Al	32	30,56	29,80	36,0	22,0		19,5	26,0	6	111	0,04
36 3M 15	2F	Al	36	34,38	33,62	38,0	26,0		20,0	30,0	6	112	0,06
40 3M 15	2F	Al	40	38,20	37,44	42,0	28,0		20,0	30,0	6	113	0,08
44 3M 15	2F	Al	44	42,02	41,26	48,0	33,0		20,0	30,0	6	114	0,10
48 3M 15	2	Al	48	45,84	45,08		33,0		20,0	30,0	8		0,10
60 3M 15	2	Al	60	57,30	56,54		33,0		20,0	30,0	8		0,15
72 3M 15	2	Al	72	68,76	68,00		33,0		20,0	30,0	8		0,21

PULEGGE DENTATE PER CINGHIE SYNCHROBELT® - “HTD” SYNCHROBELT® “HTD” TIMING BELT PULLEYS

5M

PASSO 5 mm

PER CINGHIE LARGHEZZA 9 mm

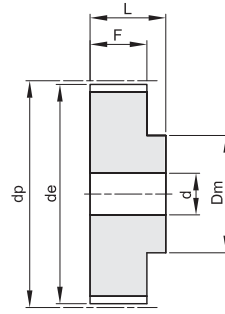

2

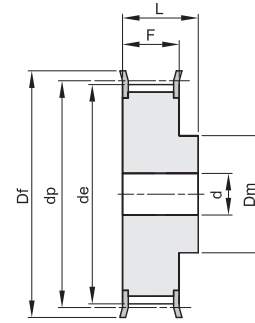

2F

Materiale: Acciaio (St)

Materiale: Alluminio UNI 9006 - T6 (Al)

adatto per l'ossidazione dura a spessore

codice	tipo	materiale	denti	dp	de	Df	Dm	Di	F	L	d	n° flangia	Kg.
12 5M 09	2F	St	12	19,10	17,96	23	12,5		14,5	20,0	6	202	0,03
14 5M 09	2F	St	14	22,28	21,14	25	13,5		14,5	20,0	6	203	0,04
15 5M 09	2F	St	15	23,87	22,73	28	16,0		14,5	20,0	6	204	0,05
16 5M 09	2F	St	16	25,46	24,32	28	16,5		14,5	20,0	6	204	0,06
18 5M 09	2F	St	18	28,65	27,51	32	20,0		14,5	20,0	6	205	0,07
20 5M 09	2F	St	20	31,83	30,69	36	23,0		14,5	22,5	6	206	0,10
21 5M 09	2F	St	21	33,42	32,28	38	24,0		14,5	22,5	6	207	0,12
22 5M 09	2F	St	22	35,01	33,87	38	25,5		14,5	22,5	6	207	0,13
24 5M 09	2F	St	24	38,20	37,06	42	27,0		14,5	22,5	6	208	0,15
26 5M 09	2F	St	26	41,38	40,24	44	30,0		14,5	22,5	6	209	0,18
28 5M 09	2F	St	28	44,56	43,42	48	30,5		14,5	22,5	6	210	0,21
30 5M 09	2F	St	30	47,75	46,60	51	35,0		14,5	22,5	6	211	0,25
32 5M 09	2F	St	32	50,93	49,79	54	38,0		14,5	22,5	8	212	0,28
36 5M 09	2F	St	36	57,30	56,16	60	38,0		14,5	22,5	8	214	0,33
40 5M 09	2F	St	40	63,66	62,52	71	38,0		14,5	22,5	8	217	0,42
44 5M 09	2	Al	44	70,03	68,89		38,0		14,5	25,5	8		0,17
48 5M 09	2	Al	48	76,39	75,25		45,0		14,5	25,5	8		0,18
60 5M 09	2	Al	60	95,49	94,35		45,0		14,5	25,5	8		0,23
72 5M 09	2	Al	72	114,59	113,45		45,0		14,5	25,5	8		0,42

PULEGGE DENTATE PER CINGHIE SYNCHROBELT® - "HTD" SYNCHROBELT® "HTD" TIMING BELT PULLEYS

5M

PASSO 5 mm

PER CINGHIE LARGHEZZA 15 mm

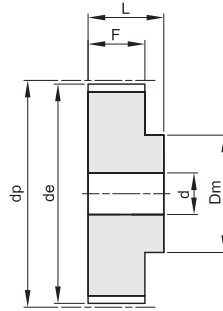

2

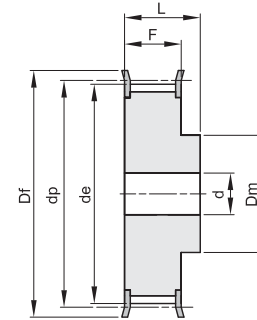

2F

Materiale: Acciaio (St)

Materiale: Alluminio UNI 9006 - T6 (Al)

adatto per l'ossidazione dura a spessore

codice	tipo	materiale	denti	dp	de	Df	Dm	Di	F	L	d	n° flangia	Kg.
12 5M 15	2F	St	12	19,10	17,96	23	12,5		20,5	26	6	202	0,03
14 5M 15	2F	St	14	22,28	21,14	25	13,5		20,5	26	6	203	0,04
15 5M 15	2F	St	15	23,87	22,73	28	16,0		20,5	26	6	204	0,05
16 5M 15	2F	St	16	25,46	24,32	28	16,5		20,5	26	6	204	0,06
18 5M 15	2F	St	18	28,65	27,51	32	20,0		20,5	26	6	205	0,09
20 5M 15	2F	St	20	31,83	30,69	36	23,0		20,5	26	6	206	0,12
21 5M 15	2F	St	21	33,42	32,28	38	24,0		20,5	26	6	207	0,14
22 5M 15	2F	St	22	35,01	33,87	38	25,5		20,5	26	6	207	0,15
24 5M 15	2F	St	24	38,20	37,06	42	27,0		20,5	28	6	208	0,19
26 5M 15	2F	St	26	41,38	40,24	44	30,0		20,5	28	6	209	0,23
28 5M 15	2F	St	28	44,56	43,42	48	30,5		20,5	28	6	210	0,26
30 5M 15	2F	St	30	47,75	46,60	51	35,0		20,5	28	6	211	0,32
32 5M 15	2F	St	32	50,93	49,79	54	38,0		20,5	28	8	212	0,35
36 5M 15	2F	St	36	57,30	56,16	60	38,0		20,5	28	8	214	0,43
40 5M 15	2F	St	40	63,66	62,52	71	38,0		20,5	28	8	217	0,52
44 5M 15	2	Al	44	70,03	68,89		38,0		20,5	30	8		0,23
48 5M 15	2	Al	48	76,39	75,25		38,0		20,5	30	8		0,29
60 5M 15	2	Al	60	95,49	94,35		50,0		20,5	30	8		0,30
72 5M 15	2	Al	72	114,59	113,45		50,0		20,5	30	8		0,59

PULEGGE DENTATE PER CINGHIE SYNCHROBELT® - “HTD” SYNCHROBELT® “HTD” TIMING BELT PULLEYS

5M

PASSO 5 mm

PER CINGHIE LARGHEZZA 25 mm

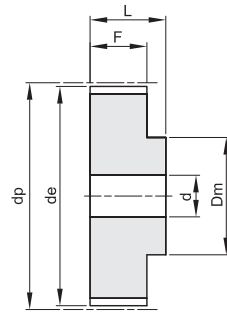

2

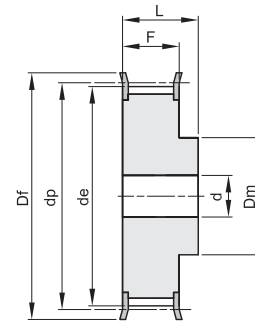

2F

Materiale: Acciaio (St)

Materiale: Alluminio UNI 9006 - T6 (Al)

adatto per l'ossidazione dura a spessore

codice	tipo	materiale	denti	dp	de	Df	Dm	Di	F	L	d	n° flangia	Kg.
12 5M 25	2F	St	12	19,10	17,96	23	12,5		30,5	36	6	202	0,05
14 5M 25	2F	St	14	22,28	21,14	25	13,5		30,5	36	6	203	0,08
15 5M 25	2F	St	15	23,87	22,73	28	16,0		30,5	36	6	204	0,09
16 5M 25	2F	St	16	25,46	24,32	28	16,5		30,5	36	6	204	0,11
18 5M 25	2F	St	18	28,65	27,51	32	20,0		30,5	36	6	205	0,13
20 5M 25	2F	St	20	31,83	30,69	36	23,0		30,5	36	6	206	0,17
21 5M 25	2F	St	21	33,42	32,28	38	24,0		30,5	38	6	207	0,20
22 5M 25	2F	St	22	35,01	33,87	38	25,5		30,5	38	6	207	0,22
24 5M 25	2F	St	24	38,20	37,06	42	27,0		30,5	38	6	208	0,26
26 5M 25	2F	St	26	41,38	40,24	44	30,0		30,5	38	6	209	0,32
28 5M 25	2F	St	28	44,56	43,42	48	30,5		30,5	38	6	210	0,37
30 5M 25	2F	St	30	47,75	46,60	51	35,0		30,5	38	6	211	0,44
32 5M 25	2F	St	32	50,93	49,79	54	38,0		30,5	38	8	212	0,48
36 5M 25	2F	St	36	57,30	56,16	60	38,0		30,5	38	8	214	0,59
40 5M 25	2F	St	40	63,66	62,52	71	38,0		30,5	38	8	217	0,75
44 5M 25	2	Al	44	70,03	68,89		38,0		30,5	40	8		0,32
48 5M 25	2	Al	48	76,39	75,25		38,0		30,5	40	8		0,28
60 5M 25	2	Al	60	95,49	94,35		50,0		30,5	40	8		0,44
72 5M 25	2	Al	72	114,59	113,45		50,0		30,5	40	8		0,85

PULEGGE DENTATE PER CINGHIE SYNCHROBELT® - "HTD" SYNCHROBELT® "HTD" TIMING BELT PULLEYS

8M

PASSO 8 mm

PER CINGHIE LARGHEZZA 20 mm

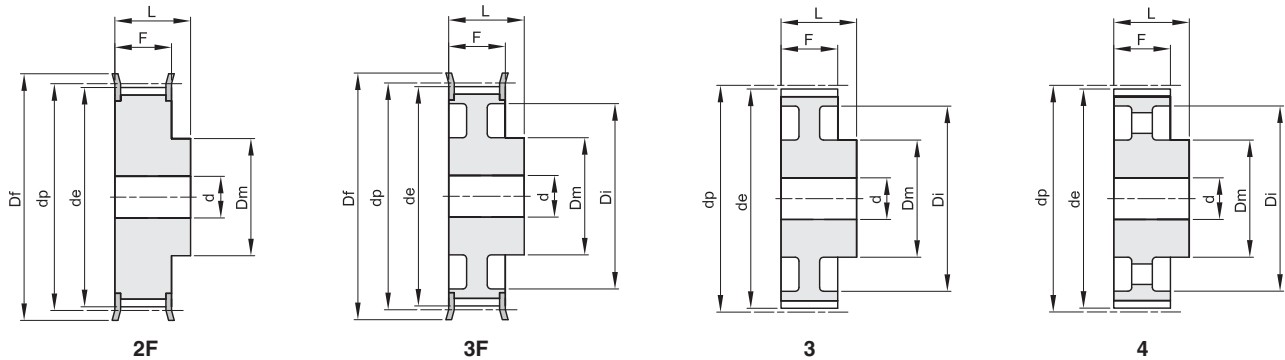

Materiale: Acciaio (St)
Materiale: Ghisa (GG)

codice	tipo	materiale	denti	dp	de	Df	Dm	Di	F	L	d	n° flangia	Kg.
22 8M 20	2F	St	22	56,02	54,65	60	43		28	38	12	308	0,54
24 8M 20	2F	St	24	61,11	59,74	66	45		28	38	12	310	0,65
26 8M 20	2F	St	26	66,21	64,84	71	48		28	38	12	311	0,80
28 8M 20	2F	St	28	71,30	70,08	75	50		28	38	14	312	0,88
30 8M 20	2F	St	30	76,39	75,13	83	55		28	38	14	314	1,00
32 8M 20	2F	St	32	81,49	80,16	87	60		28	38	14	315	1,20
34 8M 20	2F	St	34	86,58	85,21	91	66		28	38	14	316	1,40
36 8M 20	2F	St	36	91,67	90,30	98	70		28	38	14	319	1,60
38 8M 20	2F	St	38	96,77	95,39	103	75		28	38	14	320	1,70
40 8M 20	2F	St	40	101,86	100,49	106	75		28	38	14	321	1,85
44 8M 20	2F	St	44	112,05	110,67	119	75		28	38	14	325	2,10
48 8M 20	2F	St	48	122,23	120,86	127	75		28	38	14	327	2,50
56 8M 20	3F	St	56	142,60	141,23	148	80	116	28	38	14	333	2,82
64 8M 20	3F	St	64	162,97	161,60	168	80	137	28	38	14	338	3,22
72 8M 20	3F	St	72	183,35	181,97	192	80	158	28	38	14	340	3,74
80 8M 20	3	GG	80	203,72	202,35		90	180	28	38	14		3,78
90 8M 20	3	GG	90	229,18	227,81		90	204	28	38	14		4,57
* 112 8M 20	4	GG	112	285,21	283,83		90	254	28	38	18		
* 144 8M 20	4	GG	144	366,69	365,32		90	336	28	38	20		
* 168 8M 20	4	GG	168	427,81	426,44		100	400	28	38	20		
* 192 8M 20	4	GG	192	488,92	487,55		100	460	28	38	20		

* Costruite a richiesta - Manufactured on request.

PULEGGE DENTATE PER CINGHIE SYNCHROBELT® - "HTD" SYNCHROBELT® "HTD" TIMING BELT PULLEYS

8M

PASSO 8 mm

PER CINGHIE LARGHEZZA 30 mm

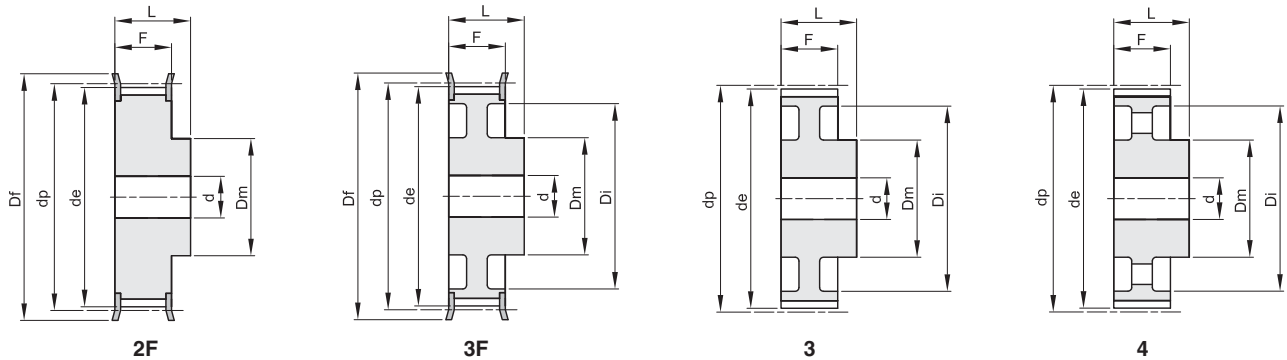

Materiale: Acciaio (St)
Materiale: Ghisa (GG)

codice	tipo	materiale	denti	dp	de	Df	Dm	Di	F	L	d	n° flangia	Kg.
22 8M 30	2F	St	22	56,02	54,65	60	43		38	48	12	308	0,75
24 8M 30	2F	St	24	61,11	59,74	66	45		38	48	12	310	0,90
26 8M 30	2F	St	26	66,21	64,84	71	48		38	48	12	311	1,10
28 8M 30	2F	St	28	71,30	70,08	75	50		38	48	14	312	1,20
30 8M 30	2F	St	30	76,39	75,13	83	55		38	48	14	314	1,32
32 8M 30	2F	St	32	81,49	80,16	87	60		38	48	14	315	1,55
34 8M 30	2F	St	34	86,58	85,21	91	66		38	48	14	316	1,80
36 8M 30	2F	St	36	91,67	90,30	98	70		38	48	14	319	2,10
38 8M 30	2F	St	38	96,77	95,39	103	75		38	48	14	320	2,30
40 8M 30	2F	St	40	101,86	100,49	106	75		38	48	14	321	2,47
44 8M 30	2F	St	44	112,05	110,67	119	75		38	48	14	325	2,95
48 8M 30	2F	St	48	122,23	120,86	127	75		38	48	14	327	3,30
56 8M 30	3F	St	56	142,60	141,23	148	90	116	38	48	14	333	4,02
64 8M 30	3F	St	64	162,97	161,60	168	90	137	38	48	14	338	4,60
72 8M 30	3F	St	72	183,35	181,97	192	95	158	38	48	14	340	5,41
80 8M 30	3	GG	80	203,72	202,35		100	180	38	48	14		5,23
90 8M 30	3	GG	90	229,18	227,81		100	204	38	48	14		6,42
112 8M 30	4	GG	112	285,21	283,83		100	254	38	48	18		8,12
144 8M 30	4	GG	144	366,69	365,32		100	336	38	48	20		10,36
168 8M 30	4	GG	168	427,81	426,44		100	400	38	48	20		12,37
192 8M 30	4	GG	192	488,92	487,55		100	460	38	48	20		14,31

PULEGGE DENTATE PER CINGHIE SYNCHROBELT® - "HTD"

SYNCHROBELT® "HTD" TIMING BELT PULLEYS

8M

PASSO 8 mm

PER CINGHIE LARGHEZZA 50 mm

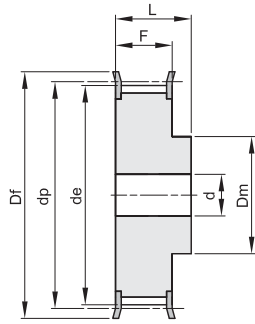

2F

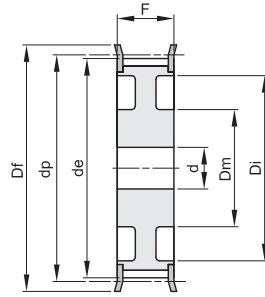

7F

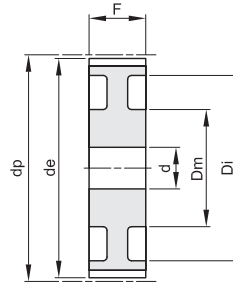

7

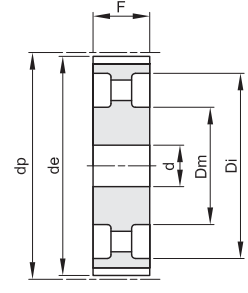

8

Materiale: Acciaio (St)
Materiale: Ghisa (GG)

codice	tipo	materiale	denti	dp	de	Df	Dm	Di	F	L	d	n° flangia	Kg.
22 8M 50	2F	St	22	56,02	54,65	60	43		60	70	12	308	1,10
24 8M 50	2F	St	24	61,11	59,74	66	45		60	70	12	310	1,30
26 8M 50	2F	St	26	66,21	64,84	71	48		60	70	12	311	1,60
28 8M 50	2F	St	28	71,30	70,08	75	50		60	70	14	312	1,70
30 8M 50	2F	St	30	76,39	75,13	83	55		60	70	14	314	2,00
32 8M 50	2F	St	32	81,49	80,16	87	60		60	70	14	315	2,35
34 8M 50	2F	St	34	86,58	85,21	91	66		60	70	14	316	2,80
36 8M 50	2F	St	36	91,67	90,30	98	70		60	70	14	319	3,10
38 8M 50	2F	St	38	96,77	95,39	103	75		60	70	14	320	3,30
40 8M 50	2F	St	40	101,86	100,49	106	75		60	70	14	321	3,60
44 8M 50	2F	St	44	112,05	110,67	119	75		60	70	14	325	4,40
48 8M 50	2F	St	48	122,23	120,86	127	75		60	70	14	327	5,00
56 8M 50	7F	St	56	142,60	141,23	148	90	116	60	60	18	333	5,68
64 8M 50	7F	St	64	162,97	161,60	168	100	137	60	60	18	338	6,93
72 8M 50	7F	St	72	183,35	181,97	192	100	158	60	60	18	340	7,95
80 8M 50	7	GG	80	203,72	202,35		110	180	60	60	18		7,96
90 8M 50	7	GG	90	229,18	227,81		110	204	60	60	18		9,20
112 8M 50	8	GG	112	285,21	283,83		110	254	60	60	18		12,16
144 8M 50	8	GG	144	366,69	365,32		110	336	60	60	20		15,68
168 8M 50	8	GG	168	427,81	426,44		120	400	60	60	20		18,99
192 8M 50	8	GG	192	488,92	487,55		130	460	60	60	20		24,09

PULEGGE DENTATE PER CINGHIE SYNCHROBELT® - "HTD" SYNCHROBELT® "HTD" TIMING BELT PULLEYS

8M

PASSO 8 mm

PER CINGHIE LARGHEZZA 85 mm

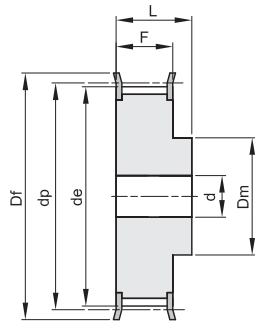

2F

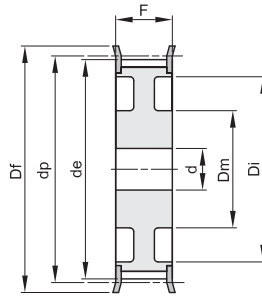

7F

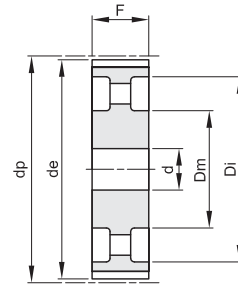

8

Materiale: Acciaio (St)

Materiale: Ghisa (GG)

codice	tipo	materiale	denti	dp	de	Df	Dm	Di	F	L	d	n° flangia	Kg.
22 8M 85	2F	St	22	56,02	54,65	60	43		95	105	12	308	1,60
24 8M 85	2F	St	24	61,11	59,74	66	45		95	105	12	310	1,95
26 8M 85	2F	St	26	66,21	64,84	71	48		95	105	12	311	2,30
28 8M 85	2F	St	28	71,30	70,08	75	50		95	105	14	312	2,60
30 8M 85	2F	St	30	76,39	75,13	83	55		95	105	14	314	3,10
32 8M 85	2F	St	32	81,49	80,16	87	60		95	105	14	315	3,70
34 8M 85	2F	St	34	86,58	85,21	91	66		95	105	14	316	4,00
36 8M 85	2F	St	36	91,67	90,30	98	70		95	105	14	319	4,70
38 8M 85	2F	St	38	96,77	95,39	103	75		95	105	14	320	5,10
40 8M 85	2F	St	40	101,86	100,49	106	75		95	105	14	321	5,40
44 8M 85	2F	St	44	112,05	110,67	119	75		95	105	14	325	6,70
48 8M 85	2F	St	48	122,23	120,86	127	75		95	105	14	327	7,20
56 8M 85	2F	St	56	142,60	141,23	148	80		95	105	18	333	11,48
64 8M 85	7F	St	64	162,97	161,60	168	100	137	95	95	18	338	11,02
72 8M 85	7F	St	72	183,35	181,97	192	110	158	95	95	18	340	13,45
80 8M 85	8	GG	80	203,72	202,35		110	180	95	95	20		12,36
90 8M 85	8	GG	90	229,18	227,81		110	204	95	95	20		14,38
112 8M 85	8	GG	112	285,21	283,83		110	254	95	95	24		18,66
144 8M 85	8	GG	144	366,69	365,32		110	341	95	95	24		23,00
* 168 8M 85	8	GG	168	427,81	426,44		120	400	95	95	24		
* 192 8M 85	8	GG	192	488,92	487,55		130	460	95	95	24		

* Costruite a richiesta - Manufactured on request.

PULEGGE DENTATE PER CINGHIE SYNCHROBELT® - "HTD" SYNCHROBELT® "HTD" TIMING BELT PULLEYS

14M

PASSO 14 mm

PER CINGHIE LARGHEZZA 40 mm

Materiale: Acciaio (St)
Materiale: Ghisa (GG)

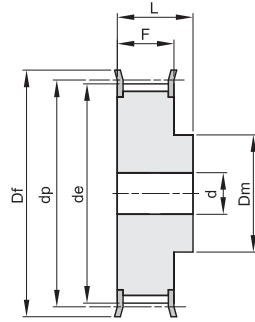

2F

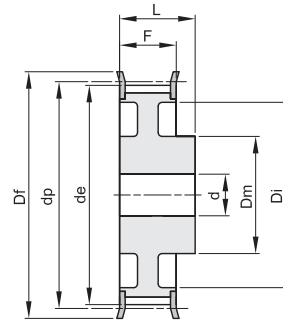

3F

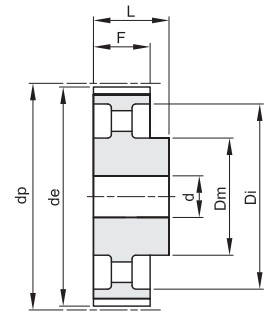

4

codice	tipo	materiale	denti	dp	de	Df	Dm	Di	F	L	d	n° flangia	Kg.
28 14M 40	2F	St	28	124,78	122,12	127	100		54	69	24	400	4,80
30 14M 40	2F	St	30	133,69	130,99	138	100		54	69	24	401	5,60
32 14M 40	2F	St	32	142,60	139,88	154	100		54	69	24	403	6,20
34 14M 40	2F	St	34	151,52	148,79	160	100		54	69	24	404	6,90
36 14M 40	2F	St	36	160,43	157,68	168	100		54	69	24	405	7,70
38 14M 40	2F	St	38	169,34	166,60	183	120		54	69	24	406	8,90
40 14M 40	2F	St	40	178,25	175,49	188	120		54	69	24	407	9,80
44 14M 40	2F	St	44	196,08	193,28	211	120		54	69	24	411	12,00
48 14M 40	3F	GG	48	213,90	211,11	226	135	170	54	69	24	412	11,98
56 14M 40	3F	GG	56	249,55	246,76	256	135	207	54	69	28	416	14,01
64 14M 40	3F	GG	64	285,21	282,41	296	135	240	54	69	28	418	16,65
72 14M 40	4	GG	72	320,86	318,06		135	278	54	69	28		15,52
80 14M 40	4	GG	80	356,51	353,71		135	314	54	69	28		17,23
90 14M 40	4	GG	90	401,07	398,28		135	358	54	69	28		19,40
112 14M 40	4	GG	112	499,11	496,32		135	456	54	69	28		24,14
* 144 14M 40	4	GG	144	641,71	638,92		135	600	54	69	28		
* 168 14M 40	4	GG	168	748,66	745,87		135	706	54	69	28		
* 192 14M 40	4	GG	192	855,62	852,82		135	813	54	69	28		

* Costruite a richiesta - Manufactured on request.

PULEGGE DENTATE PER CINGHIE SYNCHROBELT® - “HTD” SYNCHROBELT® “HTD” TIMING BELT PULLEYS

14M
PASSO 14 mm
PER CINGHIE LARGHEZZA 55 mm

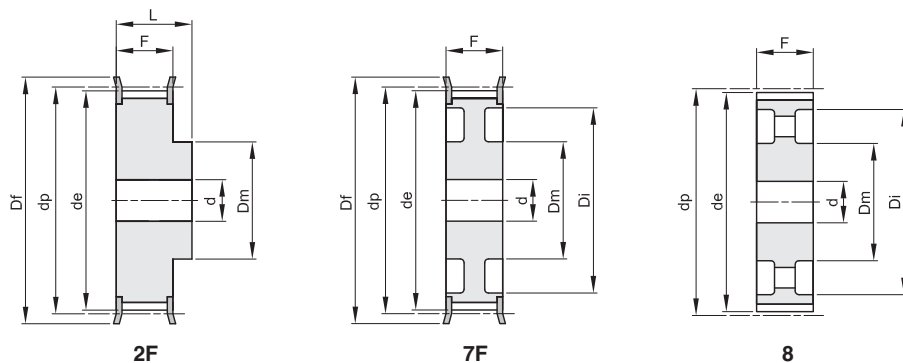

Materiale: Acciaio (St)
Materiale: Ghisa (GG)

codice	tipo	materiale	denti	dp	de	Df	Dm	Di	F	L	d	n° flangia	Kg.
28 14M 55	2F	St	28	124,78	122,12	127	100		70	85	24	400	5,70
30 14M 55	2F	St	30	133,69	130,99	138	100		70	85	24	401	7,10
32 14M 55	2F	St	32	142,60	139,88	154	100		70	85	24	403	7,90
34 14M 55	2F	St	34	151,52	148,79	160	100		70	85	24	404	9,33
36 14M 55	2F	St	36	160,43	157,68	168	100		70	85	24	405	10,49
38 14M 55	2F	St	38	169,34	166,60	183	120		70	85	24	406	12,11
40 14M 55	2F	St	40	178,25	175,49	188	120		70	85	24	407	13,30
44 14M 55	2F	St	44	196,08	193,28	211	120		70	85	24	411	16,12
48 14M 55	7F	GG	48	213,90	211,11	226	135	170	70	70	24	412	13,50
56 14M 55	7F	GG	56	249,55	246,76	256	135	207	70	70	28	416	15,78
64 14M 55	7F	GG	64	285,21	282,41	296	135	240	70	70	28	418	19,04
72 14M 55	8	GG	72	320,86	318,06		135	278	70	70	28		18,41
80 14M 55	8	GG	80	356,51	353,71		135	314	70	70	28		20,27
90 14M 55	8	GG	90	401,07	398,28		135	358	70	70	28		22,98
112 14M 55	8	GG	112	499,11	496,32		135	456	70	70	28		29,29
144 14M 55	8	GG	144	641,71	638,92		135	600	70	70	28		36,00
168 14M 55	8	GG	168	748,66	745,87		135	706	70	70	28		40,00
192 14M 55	8	GG	192	855,62	852,82		135	813	70	70	28		47,50

PULEGGE DENTATE PER CINGHIE SYNCHROBELT® - "HTD" SYNCHROBELT® "HTD" TIMING BELT PULLEYS

14M
PASSO 14 mm
PER CINGHIE LARGHEZZA 85 mm

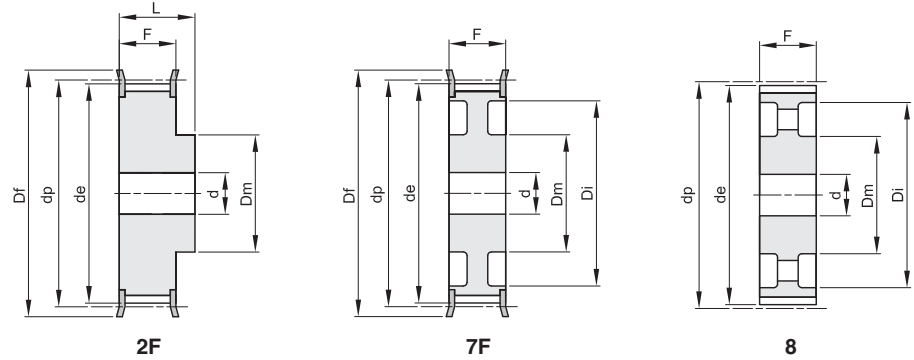

Materiale: Acciaio (St)
Materiale: Ghisa (GG)

codice	tipo	materiale	denti	dp	de	Df	Dm	Di	F	L	d	n° flangia	Kg.
28 14M 85	2F	St	28	124,78	122,12	127	100		102	117	24	400	8,77
30 14M 85	2F	St	30	133,69	130,99	138	100		102	117	24	401	10,13
32 14M 85	2F	St	32	142,60	139,88	154	100		102	117	24	403	11,65
34 14M 85	2F	St	34	151,52	148,79	160	100		102	117	24	404	13,15
36 14M 85	2F	St	36	160,43	157,68	168	100		102	117	32	405	14,48
38 14M 85	2F	St	38	169,34	166,60	183	120		102	117	32	406	16,62
40 14M 85	2F	St	40	178,25	175,49	188	135		102	117	32	407	18,84
44 14M 85	2F	St	44	196,08	193,28	211	135		102	117	32	411	22,86
48 14M 85	2F	St	48	213,90	211,11	226	150		102	117	32	412	27,58
56 14M 85	7F	GG	56	249,55	246,76	256	150	207	102	102	32	416	24,19
64 14M 85	7F	GG	64	285,21	282,41	296	150	240	102	102	32	418	28,57
72 14M 85	8	GG	72	320,86	318,06		150	278	102	102	32		28,26
80 14M 85	8	GG	80	356,51	353,71		150	314	102	102	32		31,00
90 14M 85	8	GG	90	401,07	398,28		150	358	102	102	32		35,00
112 14M 85	8	GG	112	499,11	496,32		150	456	102	102	32		43,50
144 14M 85	8	GG	144	641,71	638,92		150	600	102	102	32		50,00
168 14M 85	8	GG	168	748,66	745,87		150	706	102	102	32		63,00
192 14M 85	8	GG	192	855,62	852,82		165	813	102	102	32		76,00

PULEGGE DENTATE PER CINGHIE SYNCHROBELT® - “HTD”

SYNCHROBELT® “HTD” TIMING BELT PULLEYS

14M
PASSO 14 mm
 PER CINGHIE LARGHEZZA 115 mm

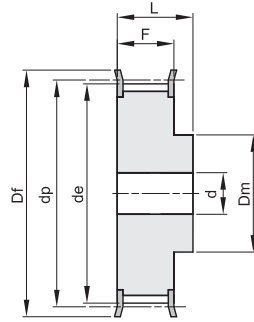

2F

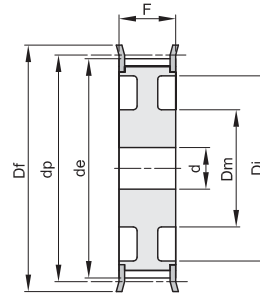

7F

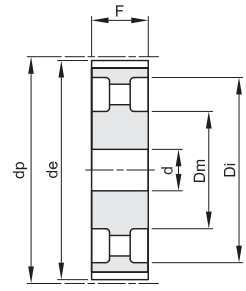

8

Materiale: Acciaio (St)
 Materiale: Ghisa (GG)

codice	tipo	materiale	denti	dp	de	Df	Dm	Di	F	L	d	n° flangia	Kg.
28 14M 115	2F	St	28	124,78	122,12	127	100		133	148	32	400	10,75
30 14M 115	2F	St	30	133,69	130,99	138	100		133	148	32	401	12,52
32 14M 115	2F	St	32	142,60	139,88	154	100		133	148	32	403	14,48
34 14M 115	2F	St	34	151,52	148,79	160	100		133	148	32	404	16,45
36 14M 115	2F	St	36	160,43	157,68	168	120		133	148	32	405	18,99
38 14M 115	2F	St	38	169,34	166,60	183	120		133	148	32	406	21,31
40 14M 115	2F	St	40	178,25	175,49	188	135		133	148	32	407	24,04
44 14M 115	2F	St	44	196,08	193,28	211	140		133	148	32	411	29,41
48 14M 115	2F	St	48	213,90	211,11	226	150		133	148	32	412	35,00
56 14M 115	2F	St	56	249,55	246,76	256	150		133	148	32	416	48,00
64 14M 115	7F	GG	64	285,21	282,41	296	150	240	133	133	32	418	36,00
72 14M 115	8	GG	72	320,86	318,06		150	278	133	133	32		36,00
80 14M 115	8	GG	80	356,51	353,71		150	314	133	133	32		40,00
90 14M 115	8	GG	90	401,07	398,28		150	358	133	133	32		45,00
112 14M 115	8	GG	112	499,11	496,32		150	456	133	133	32		55,50
144 14M 115	8	GG	144	641,71	638,92		165	600	133	133	32		71,00
168 14M 115	8	GG	168	748,66	745,87		165	706	133	133	32		83,00
192 14M 115	8	GG	192	855,62	852,82		165	813	133	133	32		96,00

PULEGGE DENTATE PER CINGHIE SYNCHROBELT® - "HTD" SYNCHROBELT® "HTD" TIMING BELT PULLEYS

14M
PASSO 14 mm
PER CINGHIE LARGHEZZA 170 mm

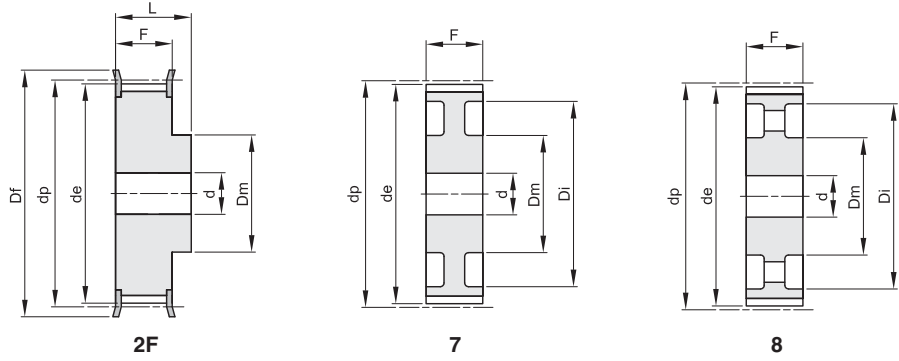

Materiale: Acciaio (St)
Materiale: Ghisa (GG)

codice	tipo	materiale	denti	dp	de	Df	Dm	Di	F	L	d	n° flangia	Kg.
28 14M 170	2F	St	28	124,78	122,12	127	100		187	202	32	400	14,79
30 14M 170	2F	St	30	133,69	130,99	138	100		187	202	32	401	17,24
32 14M 170	2F	St	32	142,60	139,88	154	100		187	202	32	403	19,92
34 14M 170	2F	St	34	151,52	148,79	160	100		187	202	32	404	22,72
36 14M 170	2F	St	36	160,43	157,68	168	120		187	202	32	405	26,07
38 14M 170	2F	St	38	169,34	166,60	183	135		187	202	32	406	29,71
40 14M 170	2F	St	40	178,25	175,49	188	140		187	202	32	407	33,50
*44 14M 170	2F	St	44	196,08	193,28	211	160		187	202	32	411	
*48 14M 170	2F	St	48	213,90	211,11	226	160		187	202	32	412	
*56 14M 170	2F	St	56	249,55	246,76	256	160		187	202	32	416	
*64 14M 170	2F	St	64	285,21	282,41	296	180		187	202	32	418	
*72 14M 170	7	GG	72	320,86	318,06		180	278	187	187	32		
80 14M 170	7	GG	80	356,51	353,71		180	314	187	187	32		71,00
90 14M 170	8	GG	90	401,07	398,28		180	358	187	187	38		73,00
112 14M 170	8	GG	112	499,11	496,32		200	456	187	187	38		95,00
144 14M 170	8	GG	144	641,71	638,92		220	600	187	187	38		114,00
168 14M 170	8	GG	168	748,66	745,87		220	706	187	187	38		142,00
*192 14M 170	8	GG	192	855,62	852,82		220	813	187	187	38		

* Costruite su richiesta - Manufactured on request.

PULEGGE DENTATE A BUSSOLA CONICA PER CINGHIE SYNCHROBELT® - "HTD" SYNCHROBELT® "HTD" TIMING BELT PULLEYS FOR TAPER BUSHES

5M

PASSO 5 mm

PER CINGHIE LARGHEZZA 15 mm

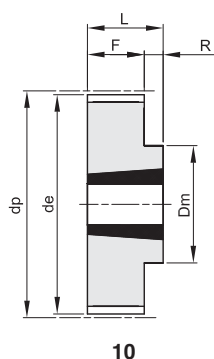

10

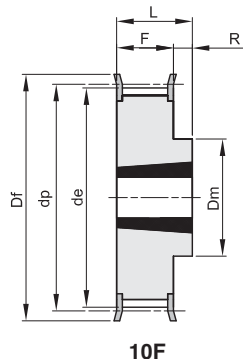

10F

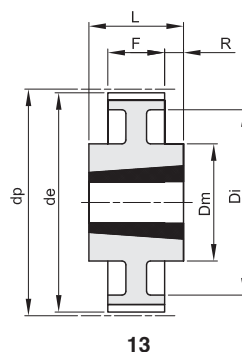

13

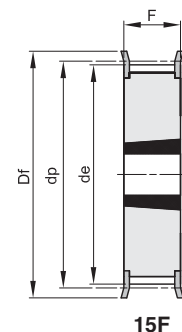

15F

Materiale: Acciaio (St)

codice	tipo	materiale	denti	bussola	foro max	dp	de	Df	Dm	Di	F	L	R	n° flangia	Kg.
TL 34 5M 15	15F	St	34	1008	25	54,11	52,97	57			22	22		213	0,20
TL 36 5M 15	15F	St	36	1108	25	57,30	56,15	60			22	22		214	0,25
TL 38 5M 15	15F	St	38	1108	25	60,48	59,34	66			22	22		216	0,30
TL 40 5M 15	15F	St	40	1108	25	63,66	62,52	71			22	22		217	0,35
TL 44 5M 15	15F	St	44	1108	25	70,03	68,89	75			22	22		218	0,40
TL 48 5M 15	10F	St	48	1210	32	76,39	75,25	83	59		22	25	3	219	0,46
TL 56 5M 15	10F	St	56	1210	32	89,13	87,99	93	70		22	25	3	222	0,60
TL 64 5M 15	10F	St	64	1210	32	101,86	100,72	106	80		22	25	3	224	0,80
TL 72 5M 15	10	St	72	1610	42	114,59	113,45		92		22	25	3		1,20
TL 80 5M 15	10	St	80	1610	42	127,32	126,18		92		22	25	3		1,76
TL 90 5M 15	10	St	90	1610	42	143,24	142,10		92		22	25	3		2,32
TL112 5M 15	10	St	112	2012	50	178,25	177,11		110		20	32	12		3,72
TL136 5M 15	13	St	136	2012	50	216,45	215,31		110	199	20	32	6		3,82

PULEGGE DENTATE A BUSSOLA CONICA PER CINGHIE SYNCHROBELT® - "HTD" SYNCHROBELT® "HTD" TIMING BELT PULLEYS FOR TAPER BUSHES

8M

PASSO 8 mm

PER CINGHIE LARGHEZZA 20 mm

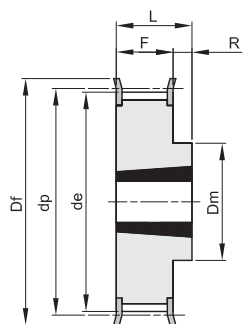

10F

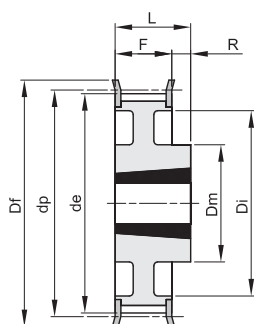

11F

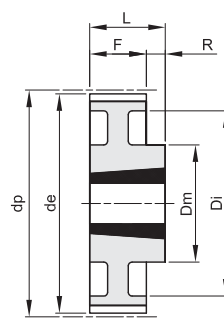

11

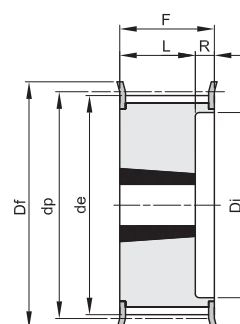

16F

Materiale: Acciaio (St)
Materiale: Ghisa (GG)

codice	tipo	materiale	denti	bussola	foro max	dp	de	Df	Dm	Di	F	L	R	n° flangia	Kg.
TL 22 8M 20	16F	St	22	1008	25	56,02	54,65	60		37	28	22	6	308	0,25
TL 24 8M 20	16F	St	24	1108	25	61,11	59,74	66		44	28	22	6	310	0,30
TL 26 8M 20	16F	St	26	1108	25	66,21	64,84	71		45	28	22	6	311	0,36
TL 28 8M 20	16F	St	28	1108	25	71,30	70,08	75		50	28	22	6	312	0,45
TL 30 8M 20	16F	St	30	1108	25	76,39	75,13	83		58	28	22	6	314	0,55
TL 32 8M 20	16F	St	32	1610	42	81,49	80,16	87		63	28	25	3	315	0,43
TL 34 8M 20	16F	St	34	1610	42	86,58	85,21	91		64	28	25	3	316	0,57
TL 36 8M 20	16F	St	36	1610	42	91,67	90,30	98		68	28	25	3	319	0,70
TL 38 8M 20	16F	St	38	1610	42	96,77	95,39	103		72	28	25	3	320	0,82
TL 40 8M 20	16F	St	40	1610	42	101,86	100,49	106		76	28	25	3	321	1,10
TL 44 8M 20	10F	St	44	2012	50	112,05	110,67	119	92		28	32	4	325	1,20
TL 48 8M 20	10F	St	48	2012	50	122,23	120,86	127	96		28	32	4	327	1,65
TL 56 8M 20	10F	St	56	2012	50	142,60	141,23	148	110		28	32	4	333	2,50
TL 64 8M 20	11F	St	64	2012	50	162,97	161,60	168	110	137	28	32	4	338	2,60
TL 72 8M 20	11F	St	72	2012	50	183,35	181,97	192	110	158	28	32	4	340	3,40
TL 80 8M 20	11	GG	80	2012	50	203,72	202,35		110	180	28	32	4		3,60
TL 90 8M 20	11	GG	90	2012	50	229,18	227,81		110	204	28	32	4		4,10

PULEGGE DENTATE A BUSSOLA CONICA PER CINGHIE SYNCHROBELT® - "HTD" SYNCHROBELT® "HTD" TIMING BELT PULLEYS FOR TAPER BUSHES

8M
PASSO 8 mm
PER CINGHIE LARGHEZZA 30 mm

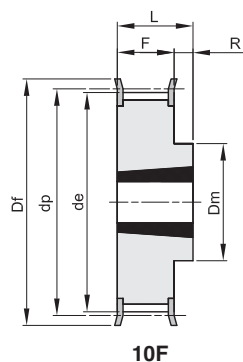

10F

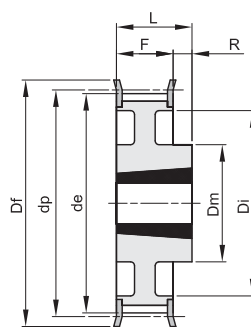

11F

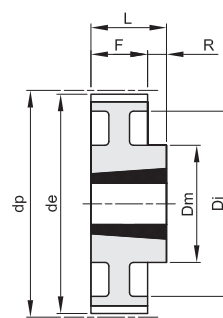

11

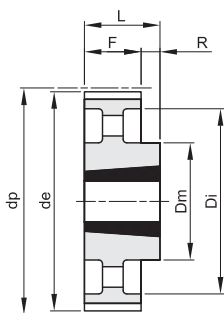

12

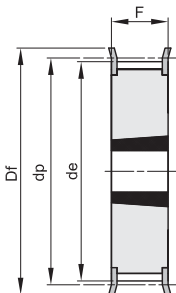

15F

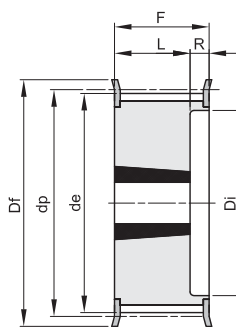

16F

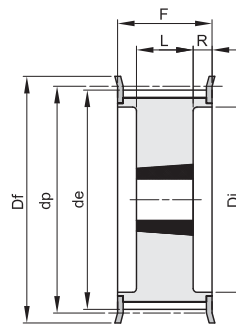

18F

Materiale: Acciaio (St)
Materiale: Ghisa (GG)

codice	tipo	materiale	denti	bussola	foro max	dp	de	Df	Dm	Di	F	L	R	n° flangia	Kg.
TL 22 8M 30	16F	St	22	1008	25	56,02	54,65	60		37	38	22	16	308	0,33
TL 24 8M 30	16F	St	24	1108	25	61,11	59,74	66		44	38	22	16	310	0,40
TL 26 8M 30	16F	St	26	1108	25	66,21	64,84	71		44	38	22	16	311	0,45
TL 28 8M 30	16F	St	28	1210	32	71,30	70,08	75		50	38	25	13	312	0,50
TL 30 8M 30	15F	St	30	1615	42	76,39	75,13	83			38	38		314	0,55
TL 32 8M 30	15F	St	32	1615	42	81,49	80,16	87			38	38		315	0,60
TL 34 8M 30	15F	St	34	1615	42	86,58	85,21	91			38	38		316	0,80
TL 36 8M 30	15F	St	36	1615	42	91,67	90,30	98			38	38		319	1,00
TL 38 8M 30	15F	St	38	1615	42	96,77	95,39	103			38	38		320	1,10
TL 40 8M 30	15F	St	40	1615	42	101,86	100,49	106			38	38		321	1,34
TL 44 8M 30	18F	St	44	2012	50	112,05	110,67	119		86	38	32	3	325	1,30
TL 48 8M 30	18F	St	48	2012	50	122,23	120,86	127		90	38	32	3	327	1,80
TL 56 8M 30	18F	St	56	2012	50	142,60	141,23	148		110	38	32	3	333	3,80
TL 64 8M 30	10F	St	64	2517	60	162,97	161,60	168	125		38	45	7	338	4,30
TL 72 8M 30	11F	St	72	2517	60	183,35	181,97	192	125	158	38	45	7	340	4,40
TL 80 8M 30	11	GG	80	2517	60	203,72	202,35		125	180	38	45	7		4,65
TL 90 8M 30	11	GG	90	2517	60	229,18	227,81		125	204	38	45	7		5,80
TL112 8M 30	12	GG	112	2517	60	285,21	283,83		125	254	38	45	7		6,20
TL144 8M 30	12	GG	144	2517	60	366,69	365,32		125	336	38	45	7		9,00

PULEGGE DENTATE A BUSSOLA CONICA PER CINGHIE SYNCHROBELT® - "HTD" SYNCHROBELT® "HTD" TIMING BELT PULLEYS FOR TAPER BUSHES

8M
PASSO 8 mm
PER CINGHIE LARGHEZZA 50 mm

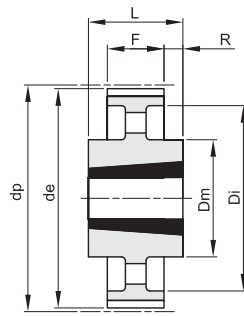

14

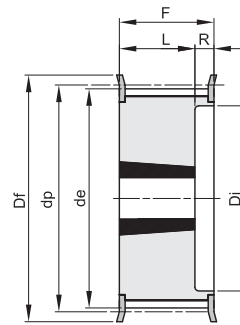

16F

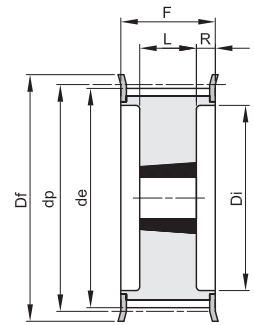

18F

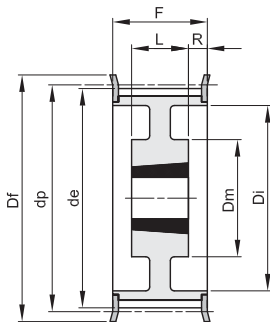

19F

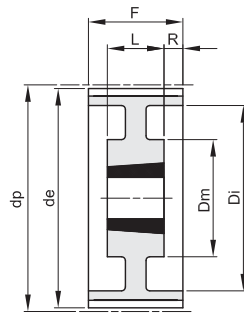

19

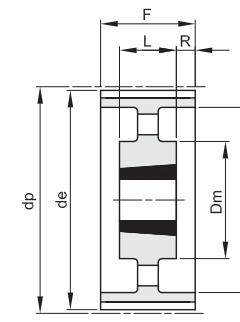

20

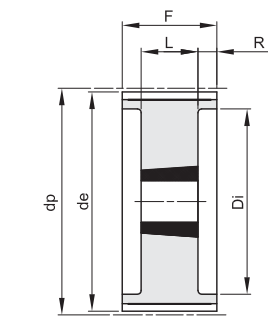

18

Materiale: Acciaio (St)
Materiale: Ghisa (GG)

codice	tipo	materiale	denti	bussola	foro max	dp	de	Df	Dm	Di	F	L	R	n° flangia	Kg.
TL 28 8M 50	16F	St	28	1210	32	71,30	70,08	75		50	60	25	35	312	0,60
TL 30 8M 50	16F	St	30	1615	42	76,39	75,13	83		58	60	38	22	314	0,65
TL 32 8M 50	16F	St	32	1615	42	81,49	80,16	87		63	60	38	22	315	0,80
TL 34 8M 50	16F	St	34	1615	42	86,58	85,21	91		65	60	38	22	316	1,08
TL 36 8M 50	16F	St	36	1615	42	91,67	90,30	98		68	60	38	22	319	1,35
TL 38 8M 50	16F	St	38	1615	42	96,77	95,39	103		72	60	38	22	320	1,65
TL 40 8M 50	18F	St	40	2012	50	101,86	100,49	106		80	60	32	14	321	1,70
TL 44 8M 50	18F	St	44	2012	50	112,05	110,67	119		86	60	32	14	325	1,80
TL 48 8M 50	18F	St	48	2012	50	122,23	120,86	127		95	60	32	14	327	2,35
TL 56 8M 50	18F	St	56	2517	60	142,60	141,23	148		116	60	45	7,5	333	3,35
TL 64 8M 50	18F	St	64	2517	60	162,97	161,60	168		136	60	45	7,5	338	4,90
TL 72 8M 50	19F	St	72	2517	60	183,35	181,97	192	125	158	60	45	7,5	340	6,90
TL 80 8M 50	18	GG	80	3020	75	203,72	202,35			180	60	51	4,5		8,90
TL 90 8M 50	19	GG	90	3020	75	229,18	227,81		160	204	60	51	4,5		9,90
TL112 8M 50	19	GG	112	3020	75	285,21	283,83		170	254	60	51	4,5		12,10
TL144 8M 50	20	GG	144	3020	75	366,69	365,32		170	336	60	51	4,5		15,40
TL168 8M 50	14	GG	168	3525	90	427,81	426,44		198	395	60	65	2,5		22,80
TL192 8M 50	14	GG	192	3525	90	488,92	487,55		198	455	60	65	2,5		26,50

PULEGGE DENTATE A BUSSOLA CONICA PER CINGHIE SYNCHROBELT® - "HTD" SYNCHROBELT® "HTD" TIMING BELT PULLEYS FOR TAPER BUSHES

8M

PASSO 8 mm

PER CINGHIE LARGHEZZA 85 mm

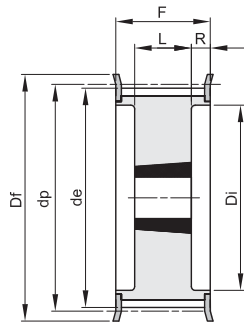

18F

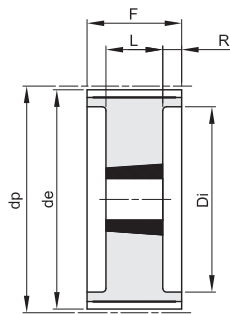

18

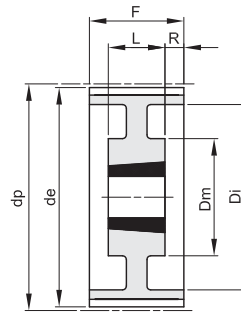

19

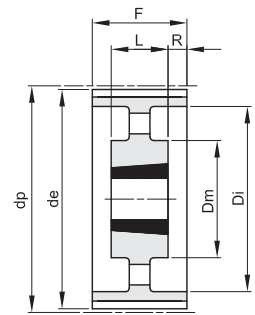

20

Materiale: Acciaio (St)
Materiale: Ghisa (GG)

codice	tipo	materiale	denti	bussola	foro max	dp	de	Df	Dm	Di	F	L	R	n° flangia	Kg.
TL 34 8M 85	18F	St	34	1615	42	86,58	85,22	91		65	95	38	28,5	316	1,50
TL 36 8M 85	18F	St	36	1615	42	91,67	90,30	98		68	95	38	28,5	319	1,90
TL 38 8M 85	18F	St	38	1615	42	96,77	95,39	103		72	95	38	28,5	320	2,20
TL 40 8M 85	18F	St	40	2012	50	101,86	100,49	106		80	95	32	31,5	321	1,90
TL 44 8M 85	18F	St	44	2012	50	112,05	110,67	119		86	95	32	31,5	325	2,30
TL 48 8M 85	18F	St	48	2517	60	122,23	120,86	127		97	95	45	25	327	2,70
TL 56 8M 85	18F	St	56	2517	60	142,60	141,23	148		116	95	45	25	333	4,50
TL 64 8M 85	18F	St	64	2517	60	162,97	161,60	168		136	95	45	25	338	6,30
TL 72 8M 85	18F	St	72	3020	75	183,35	181,97	192		150	95	51	22	340	8,10
TL 80 8M 85	18	GG	80	3020	75	203,72	202,35			180	95	51	22		10,20
TL 90 8M 85	19	GG	90	3020	75	229,18	227,81		170	204	95	51	22		11,20
TL112 8M 85	19	GG	112	3020	75	285,21	283,83		170	254	95	51	22		15,00
TL144 8M 85	20	GG	144	3525	90	366,69	365,32		198	336	95	65	15		20,20
TL168 8M 85	20	GG	168	3525	90	427,81	426,44		198	395	95	65	15		22,40
TL192 8M 85	20	GG	192	3525	90	488,92	487,55		198	455	95	65	15		28,20

PULEGGE DENTATE A BUSSOLA CONICA PER CINGHIE SYNCHROBELT® - "HTD" SYNCHROBELT® "HTD" TIMING BELT PULLEYS FOR TAPER BUSHES

14M

PASSO 14 mm

PER CINGHIE LARGHEZZA 40 mm

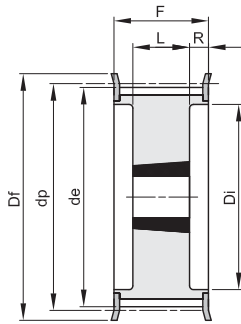

18F

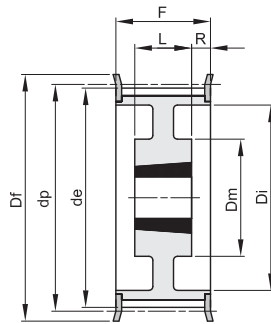

19F

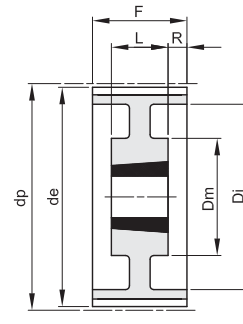

19

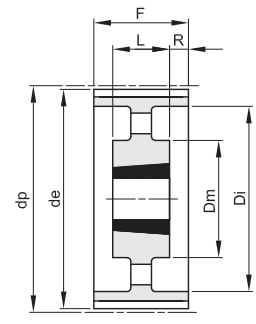

20

Materiale: Acciaio (St)
Materiale: Ghisa (GG)

codice	tipo	materiale denti	bussola	foro max	dp	de	Df	Dm	Di	F	L	R	n° flangia	Kg.	
TL 28 14M 40	18F	St	28	2012	50	124,78	122,12	127	94	54	32	11	400	2,10	
TL 30 14M 40	18F	St	30	2012	50	133,69	130,99	138	98	54	32	11	401	2,70	
TL 32 14M 40	18F	St	32	2012	50	142,60	139,88	154	108	54	32	11	403	3,40	
TL 34 14M 40	18F	St	34	2517	60	151,52	148,79	160	110	54	45	4,5	404	3,90	
TL 36 14M 40	18F	St	36	2517	60	160,43	157,68	168	120	54	45	4,5	405	4,80	
TL 38 14M 40	18F	St	38	2517	60	169,34	166,60	183	130	54	45	4,5	406	5,40	
TL 40 14M 40	18F	St	40	2517	60	178,25	175,49	188	138	54	45	4,5	407	6,00	
TL 44 14M 40	18F	St	44	3020	75	196,08	193,28	211	155	54	51	1,5	411	7,50	
TL 48 14M 40	18F	St	48	3020	75	213,90	211,11	226	170	54	51	1,5	412	8,50	
TL 56 14M 40	18F	GG	56	3020	75	249,55	246,76	256	208	54	51	1,5	416	10,10	
TL 64 14M 40	19F	GG	64	3020	75	285,21	282,41	296	170	240	54	51	1,5	418	13,40
TL 72 14M 40	19	GG	72	3020	75	320,86	318,06	170	280	54	51	1,5		15,00	
TL 80 14M 40	20	GG	80	3020	75	356,51	353,71	170	315	54	51	1,5		16,00	
TL 90 14M 40	20	GG	90	3020	75	401,07	398,28	170	360	54	51	1,5		18,00	
TL112 14M 40	20	GG	112	3020	75	499,11	496,32	170	457	54	51	1,5		25,50	
TL144 14M 40	20	GG	144	3020	75	641,71	638,92	170	600	54	51	1,5		32,00	
TL168 14M 40	20	GG	168	3020	75	748,66	745,87	170	706	54	51	1,5		43,50	
TL192 14M 40	20	GG	192	3020	75	855,62	852,82	170	813	54	51	1,5		49,50	

PULEGGE DENTATE A BUSSOLA CONICA PER CINGHIE SYNCHROBELT® - "HTD" SYNCHROBELT® "HTD" TIMING BELT PULLEYS FOR TAPER BUSHES

14M

PASSO 14 mm

PER CINGHIE LARGHEZZA 55 mm

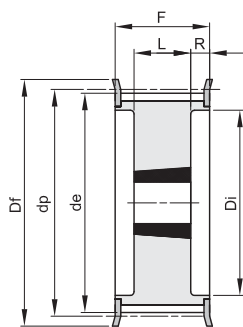

18F

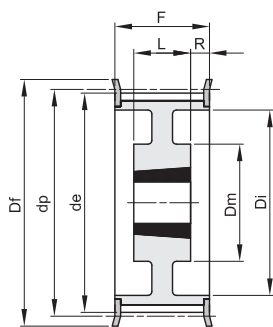

19F

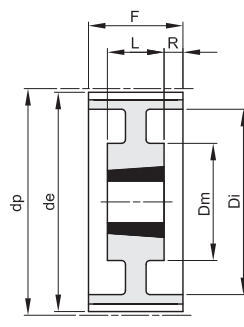

19

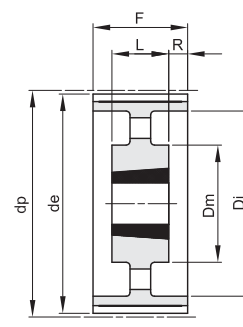

20

Materiale: Acciaio (St)
Materiale: Ghisa (GG)

codice	tipo	materiale	denti	bussola	foro max	dp	de	Df	Dm	Di	F	L	R	n° flangia	Kg.
TL 28 14M 55	18F	St	28	2012	50	124,78	122,12	127		94	70	32	19	400	2,20
TL 30 14M 55	18F	St	30	2517	60	133,69	130,99	138		100	70	45	12,5	401	2,70
TL 32 14M 55	18F	St	32	2517	60	142,60	139,88	154		108	70	45	12,5	403	3,60
TL 34 14M 55	18F	St	34	2517	60	151,52	148,79	160		110	70	45	12,5	404	4,50
TL 36 14M 55	18F	St	36	2517	60	160,43	157,68	168		120	70	45	12,5	405	5,20
TL 38 14M 55	18F	St	38	2517	60	169,34	166,60	183		130	70	45	12,5	406	6,20
TL 40 14M 55	18F	St	40	2517	60	178,25	175,49	188		138	70	45	12,5	407	6,90
TL 44 14M 55	18F	St	44	3020	75	196,08	193,28	211		155	70	51	9,5	411	8,60
TL 48 14M 55	18F	St	48	3020	75	213,90	211,11	226		170	70	51	9,5	412	10,50
TL 56 14M 55	18F	GG	56	3020	75	249,55	246,76	256		208	70	51	9,5	416	13,50
TL 64 14M 55	19F	GG	64	3020	75	285,21	282,41	296	170	240	70	51	9,5	418	14,50
TL 72 14M 55	19	GG	72	3020	75	320,86	318,06		170	280	70	51	9,5		16,30
TL 80 14M 55	20	GG	80	3020	75	356,51	353,71		170	315	70	51	9,5		17,50
TL 90 14M 55	20	GG	90	3020	75	401,07	398,28		170	360	70	51	9,5		20,00
TL112 14M 55	20	GG	112	3020	75	499,11	496,32		170	457	70	51	9,5		28,20
TL144 14M 55	20	GG	144	3020	75	641,71	638,92		170	600	70	51	9,5		36,00
TL168 14M 55	20	GG	168	3020	75	748,66	745,87		170	706	70	51	9,5		48,50
TL192 14M 55	20	GG	192	3020	75	855,62	852,82		170	813	70	51	9,5		52,00

PULEGGE DENTATE A BUSSOLA CONICA PER CINGHIE SYNCHROBELT® - "HTD" SYNCHROBELT® "HTD" TIMING BELT PULLEYS FOR TAPER BUSHES

14M

PASSO 14 mm

PER CINGHIE LARGHEZZA 85 mm

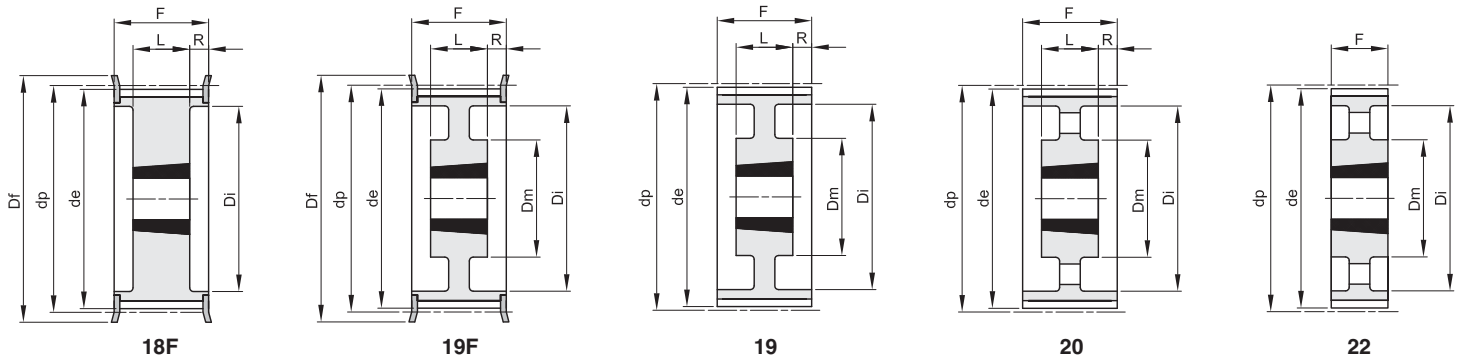

Materiale: Acciaio (St)
Materiale: Ghisa (GG)

codice	tipo	materiale	denti	bussola	foro max	dp	de	Df	Dm	Di	F	L	R	n° flangia	Kg.
TL 28 14M 85	18F	St	28	2517	60	124,78	122,12	127		98	102	45	28,5	400	2,70
TL 30 14M 85	18F	St	30	2517	60	133,69	130,99	138		100	102	45	28,5	401	3,80
TL 32 14M 85	18F	St	32	2517	60	142,60	139,88	154		108	102	45	28,5	403	4,70
TL 34 14M 85	18F	St	34	2517	60	151,52	148,79	160		110	102	45	28,5	404	6,00
TL 36 14M 85	18F	St	36	3020	75	160,43	157,68	168		125	102	51	25,5	405	5,70
TL 38 14M 85	18F	St	38	3020	75	169,34	166,60	183		130	102	51	25,5	406	6,80
TL 40 14M 85	18F	St	40	3020	75	178,25	175,49	188		138	102	51	25,5	407	8,00
TL 44 14M 85	18F	St	44	3030	75	196,08	193,28	211		155	102	76	13	411	11,70
TL 48 14M 85	18F	St	48	3030	75	213,90	211,11	226		170	102	76	13	412	15,00
TL 56 14M 85	18F	GG	56	3525	90	249,55	246,76	256		210	102	65	18,5	416	19,00
TL 64 14M 85	19F	GG	64	3525	90	285,21	282,41	296	190	240	102	65	18,5	418	23,50
TL 72 14M 85	19	GG	72	3525	90	320,86	318,06		190	280	102	65	18,5		25,00
TL 80 14M 85	20	GG	80	3525	90	356,51	353,71		190	315	102	65	18,5		26,00
TL 90 14M 85	20	GG	90	3525	90	401,07	398,28		190	360	102	65	18,5		28,00
TL112 14M 85	20	GG	112	3525	90	499,11	496,32		190	457	102	65	18,5		36,00
TL144 14M 85	20	GG	144	3525	90	641,71	638,92		190	600	102	65	18,5		48,00
TL168 14M 85	20	GG	168	3525	90	748,66	745,87		190	706	102	65	18,5		60,00
TL192 14M 85	22	GG	192	4040	100	855,62	852,82		230	813	102	102			85,00

PULEGGE DENTATE A BUSSOLA CONICA PER CINGHIE SYNCHROBELT® - "HTD" SYNCHROBELT® "HTD" TIMING BELT PULLEYS FOR TAPER BUSHES

14M

PASSO 14 mm

PER CINGHIE LARGHEZZA 115 mm

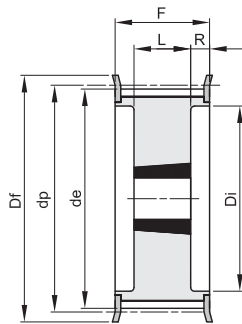

18F

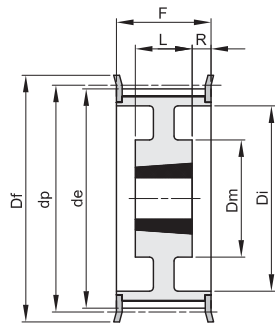

19F

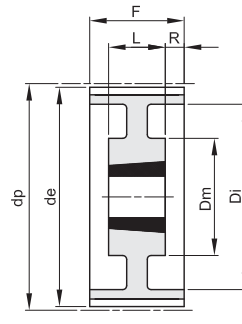

19

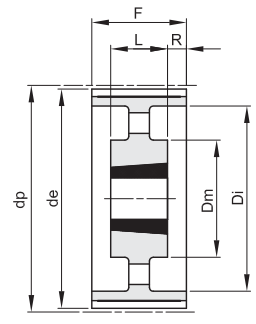

20

Materiale: Acciaio (St)
Materiale: Ghisa (GG)

codice	tipo	materiale denti	bussola	foro max	dp	de	Df	Dm	Di	F	L	R	n° flangia	Kg.
TL 28 14M 115	18F	St	28	2517	60	124,78	122,12	127	98	133	45	44	400	3,80
TL 30 14M 115	18F	St	30	2517	60	133,69	130,99	138	100	133	45	44	401	5,00
TL 32 14M 115	18F	St	32	2517	60	142,60	139,88	154	108	133	45	44	403	6,80
TL 34 14M 115	18F	St	34	2517	60	151,52	148,79	160	110	133	45	44	404	6,90
TL 36 14M 115	18F	St	36	3020	75	160,43	157,68	168	125	133	51	41	405	7,00
TL 38 14M 115	18F	St	38	3020	75	169,34	166,60	183	130	133	51	41	406	8,50
TL 40 14M 115	18F	St	40	3020	75	178,25	175,49	188	138	133	51	41	407	9,10
TL 44 14M 115	18F	St	44	3030	75	196,08	193,28	211	155	133	76	28,5	411	13,00
TL 48 14M 115	18F	St	48	3030	75	213,90	211,11	226	170	133	76	28,5	412	16,00
TL 56 14M 115	18F	GG	56	3535	90	249,55	246,76	256	210	133	89	22	416	24,00
TL 64 14M 115	19F	GG	64	3535	90	285,21	282,41	296	190	240	89	22	418	32,00
TL 72 14M 115	19	GG	72	3535	90	320,86	318,06	190	280	133	89	22		31,00
TL 80 14M 115	20	GG	80	3535	90	356,51	353,71	190	315	133	89	22		32,00
TL 90 14M 115	20	GG	90	3535	90	401,07	398,28	190	360	133	89	22		37,00
TL112 14M 115	20	GG	112	3535	90	499,11	496,32	190	457	133	89	22		45,00
TL144 14M 115	20	GG	144	4040	100	641,71	638,92	230	600	133	102	15,5		63,00
TL168 14M 115	20	GG	168	4040	100	748,66	745,87	230	706	133	102	15,5		77,50
TL192 14M 115	20	GG	192	4040	100	855,62	852,82	230	813	133	102	15,5		95,00

PULEGGE DENTATE A BUSSOLA CONICA PER CINGHIE SYNCHROBELT® - "HTD" SYNCHROBELT® "HTD" TIMING BELT PULLEYS FOR TAPER BUSHES

14M

PASSO 14 mm

PER CINGHIE LARGHEZZA 170 mm

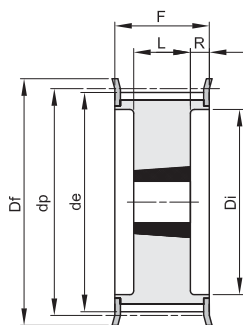

18F

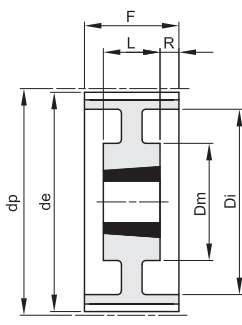

19

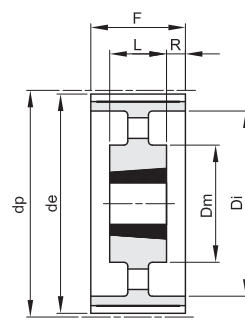

20

Materiale: Acciaio (St)
Materiale: Ghisa (GG)

codice	tipo	materiale	denti	bussola	foro max	dp	de	Df	Dm	Di	F	L	R	n° flangia	Kg.
TL 38 14M 170	18F	St	38	3030	75	169,34	166,60	183			187	76	55,5	406	11,70
TL 40 14M 170	18F	St	40	3030	75	178,25	175,49	188			187	76	55,5	407	13,00
TL 44 14M 170	18F	St	44	3535	90	196,08	193,28	211			187	89	49	411	15,00
TL 48 14M 170	18F	St	48	3535	90	213,90	211,11	226			187	89	49	412	19,00
TL 56 14M 170	18F	St	56	3535	90	249,55	246,76	256			187	89	49	416	28,50
TL 64 14M 170	18F	GG	64	4040	100	285,21	282,41	296			187	102	42,5	418	41,00
TL 72 14M 170	19	GG	72	4040	100	320,86	318,06		230		187	102	42,5		47,00
TL 80 14M 170	19	GG	80	4040	100	356,51	353,71		230		187	102	42,5		48,00
TL 90 14M 170	20	GG	90	4040	100	401,07	398,28		230		187	102	42,5		52,50
TL112 14M 170	20	GG	112	5050	125	499,11	496,32		265		187	127	30		74,50
TL144 14M 170	20	GG	144	5050	125	641,71	638,92		265		187	127	30		91,00
TL168 14M 170	20	GG	168	5050	125	748,66	745,87		265		187	127	30		116,00
TL192 14M 170	20	GG	192	5050	125	855,62	852,82		265		187	127	30		134,00

PULEGGE DENTATE PASSO METRICO SERIE "T" - DIN 7721-2

METRIC PULLEYS "T" - DIN 7721-2

T 2,5
PASSO 2,5 mm
 PER CINGHIA LARGHEZZA 6 mm

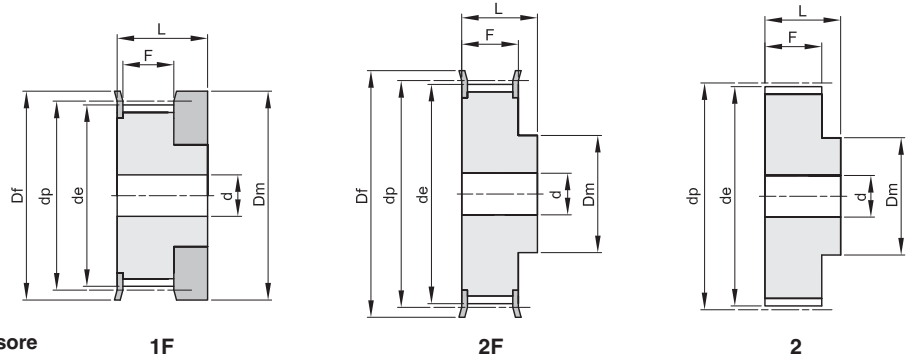

Materiale: Alluminio UNI 9006 - T6 (Al)
 adatto per l'ossidazione dura a spessore

codice	tipo	materiale	denti	de	Df	Dm	F	L	d	n° flangia	Kg.
16 T 2,5 12	1F	Al	12	9,00	13	12	9	16		100	0,01
16 T 2,5 14	1F	Al	14	10,60	15	14	9	16		101	0,01
16 T 2,5 15	1F	Al	15	11,40	15	15	9	16		101	0,01
16 T 2,5 16	1F	Al	16	12,20	16	16	9	16		102	0,01
16 T 2,5 18	2F	Al	18	13,80	18	10	10	16	3	104	0,01
16 T 2,5 19	2F	Al	19	14,60	18	10	10	16	3	104	0,01
16 T 2,5 20	2F	Al	20	15,40	19,5	11	10	16	3	105	0,01
16 T 2,5 22	2F	Al	22	17,00	23	11	10	16	3	106	0,01
16 T 2,5 24	2F	Al	24	18,55	23	12	10	16	3	107	0,01
16 T 2,5 25	2F	Al	25	19,35	23	13	10	16	3	107	0,01
16 T 2,5 26	2F	Al	26	20,15	25	14	10	16	4	108	0,01
16 T 2,5 28	2F	Al	28	21,75	25	14	10	16	4	108	0,02
16 T 2,5 30	2F	Al	30	23,35	28	16	10	16	6	109	0,02
16 T 2,5 32	2F	Al	32	24,95	32	16	10	16	6	110	0,02
16 T 2,5 36	2F	Al	36	28,10	36	20	10	16	6	111	0,03
16 T 2,5 40	2F	Al	40	31,30	38	22	10	16	6	112	0,03
16 T 2,5 44	2	Al	44	34,50		24	10	16	6		0,04
16 T 2,5 48	2	Al	48	37,70		26	10	16	6		0,05
16 T 2,5 60	2	Al	60	47,25		34	10	16	8		0,07

PULEGGE DENTATE PASSO METRICO SERIE "T" - DIN 7721-2

METRIC PULLEYS "T" - DIN 7721-2

T 5
PASSO 5 mm
 PER CINGHIA LARGHEZZA 10 mm

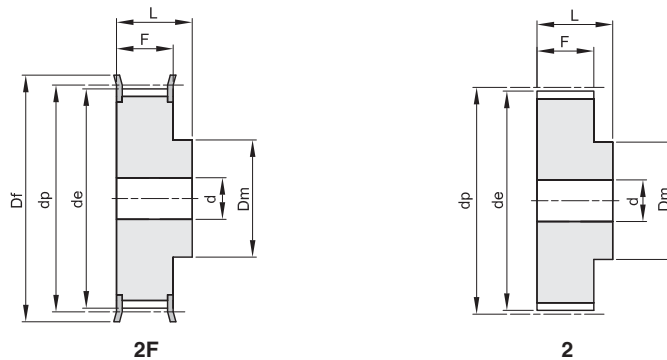

Materiale: Alluminio UNI 9006 - T6 (Al)
 adatto per l'ossidazione dura a spessore

codice	tipo	materiale	denti	de	Df	Dm	F	L	d	n° flangia	Kg.
21 T 5 10	2F	Al	10	15,05	19,5	8	15	21		200	0,01
21 T 5 12	2F	Al	12	18,25	23	10	15	21		201	0,01
21 T 5 14	2F	Al	14	21,45	25	13	15	21		203	0,02
21 T 5 15	2F	Al	15	23,05	28	16	15	21		204	0,02
21 T 5 16	2F	Al	16	24,60	32	18	15	21		205	0,03
21 T 5 18	2F	Al	18	27,80	32	20	15	21		205	0,03
21 T 5 19	2F	Al	19	29,40	36	22	15	21		206	0,04
21 T 5 20	2F	Al	20	31,00	36	23	15	21		206	0,04
21 T 5 22	2F	Al	22	34,25	38	24	15	21		207	0,05
21 T 5 24	2F	Al	24	37,40	42	26	15	21		208	0,06
21 T 5 25	2F	Al	25	38,95	44	26	15	21		209	0,06
21 T 5 26	2F	Al	26	40,60	44	26	15	21		209	0,06
21 T 5 27	2F	Al	27	42,20	48	30	15	21	8	210	0,07
21 T 5 28	2F	Al	28	43,75	48	32	15	21	8	210	0,07
21 T 5 30	2F	Al	30	46,95	51	34	15	21	8	211	0,07
21 T 5 32	2F	Al	32	50,10	54	38	15	21	8	212	0,09
21 T 5 36	2F	Al	36	56,45	63	38	15	21	8	215	0,11
21 T 5 40	2F	Al	40	62,85	66	40	15	21	8	216	0,14
21 T 5 42	2F	Al	42	66,00	71	40	15	21	8	217	0,18
21 T 5 44	2	Al	44	69,20		45	15	21	8		0,18
21 T 5 48	2	Al	48	75,55		50	15	21	8		0,20
21 T 5 60	2	Al	60	94,65		65	15	21	8		0,31

PULEGGE DENTATE PASSO METRICO SERIE "T" - DIN 7721-2

METRIC PULLEYS "T" - DIN 7721-2

T 5

PASSO 5 mm

PER CINGHIA LARGHEZZA 16 mm

Materiale: Alluminio UNI 9006 - T6 (Al)
adatto per l'ossidazione dura a spessore

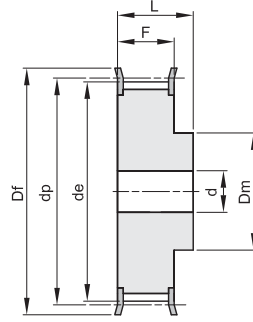

2F

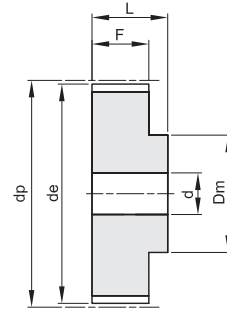

2

codice	tipo	materiale	dent	de	Df	Dm	F	L	d	n° flangia	Kg.
27 T 5 10	2F	Al	10	15,05	19,5	8	21	27		200	0,02
27 T 5 12	2F	Al	12	18,25	23	10	21	27		201	0,02
27 T 5 14	2F	Al	14	21,45	25	13	21	27		203	0,03
27 T 5 15	2F	Al	15	23,05	28	16	21	27		204	0,03
27 T 5 16	2F	Al	16	24,60	32	18	21	27		205	0,04
27 T 5 18	2F	Al	18	27,80	32	20	21	27		205	0,04
27 T 5 19	2F	Al	19	29,40	36	22	21	27		206	0,05
27 T 5 20	2F	Al	20	31,00	36	23	21	27		206	0,06
27 T 5 22	2F	Al	22	34,25	38	24	21	27		207	0,06
27 T 5 24	2F	Al	24	37,40	42	26	21	27		208	0,08
27 T 5 25	2F	Al	25	38,95	44	26	21	27		209	0,08
27 T 5 26	2F	Al	26	40,60	44	26	21	27		209	0,09
27 T 5 27	2F	Al	27	42,20	48	30	21	27	8	210	0,09
27 T 5 28	2F	Al	28	43,75	48	32	21	27	8	210	0,09
27 T 5 30	2F	Al	30	46,95	51	34	21	27	8	211	0,10
27 T 5 32	2F	Al	32	50,10	54	38	21	27	8	212	0,12
27 T 5 36	2F	Al	36	56,45	63	38	21	27	8	215	0,16
27 T 5 40	2F	Al	40	62,85	66	40	21	27	8	216	0,19
27 T 5 42	2F	Al	42	66,00	71	40	21	27	8	217	0,20
27 T 5 44	2	Al	44	69,20		45	21	27	8		0,23
27 T 5 48	2	Al	48	75,55		50	21	27	8		0,28
27 T 5 60	2	Al	60	94,65		65	21	27	8		0,43

PULEGGE DENTATE PASSO METRICO SERIE "T" - DIN 7721-2

METRIC PULLEYS "T" - DIN 7721-2

T 5
PASSO 5 mm
 PER CINGHIA LARGHEZZA 25 mm

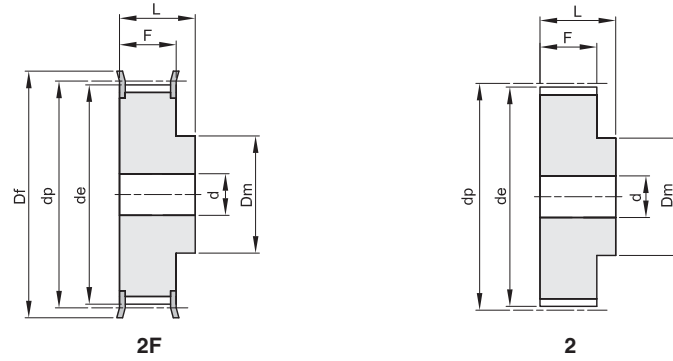

Materiale: Alluminio UNI 9006 - T6 (Al)
 adatto per l'ossidazione dura a spessore

codice	tipo	materiale	denti	de	Df	Dm	F	L	d	n° flangia	Kg.
36 T 5 10	2F	Al	10	15,05	19,5	8	30	36		200	0,02
36 T 5 12	2F	Al	12	18,25	23	10	30	36		201	0,03
36 T 5 14	2F	Al	14	21,45	25	13	30	36		203	0,04
36 T 5 15	2F	Al	15	23,05	28	16	30	36		204	0,04
36 T 5 16	2F	Al	16	24,60	32	18	30	36		205	0,05
36 T 5 18	2F	Al	18	27,80	32	20	30	36		205	0,06
36 T 5 19	2F	Al	19	29,40	36	22	30	36		206	0,07
36 T 5 20	2F	Al	20	31,00	36	23	30	36		206	0,08
36 T 5 22	2F	Al	22	34,25	38	24	30	36		207	0,08
36 T 5 24	2F	Al	24	37,40	42	26	30	36		208	0,11
36 T 5 25	2F	Al	25	38,95	44	26	30	36		209	0,12
36 T 5 26	2F	Al	26	40,60	44	26	30	36		209	0,12
36 T 5 27	2F	Al	27	42,20	48	30	30	36	8	210	0,13
36 T 5 28	2F	Al	28	43,75	48	32	30	36	8	210	0,14
36 T 5 30	2F	Al	30	46,95	51	34	30	36	8	211	0,15
36 T 5 32	2F	Al	32	50,10	54	38	30	36	8	212	0,18
36 T 5 36	2F	Al	36	56,45	63	38	30	36	8	215	0,23
36 T 5 40	2F	Al	40	62,85	66	40	30	36	8	216	0,28
36 T 5 42	2F	Al	42	66,00	71	40	30	36	8	217	0,29
36 T 5 44	2	Al	44	69,20		45	30	36	8		0,31
36 T 5 48	2	Al	48	75,55		50	30	36	8		0,40
36 T 5 60	2	Al	60	94,65		65	30	36	8		0,61

PULEGGE DENTATE PASSO METRICO SERIE "T" - DIN 7721-2

METRIC PULLEYS "T" - DIN 7721-2

T 10
PASSO 10 mm
 PER CINGHIA LARGHEZZA 16 mm

Materiale: Alluminio UNI 9006 - T6 (Al)
 adatto per l'ossidazione dura a spessore

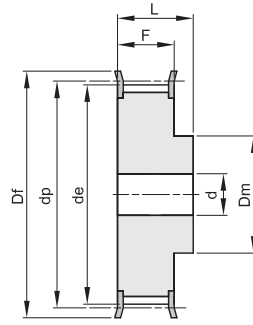

2F

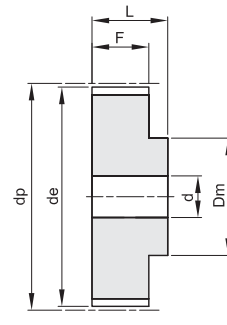

2

codice	tipo	materiale	denti	de	Df	Dm	F	L	d	n° flangia	Kg.
31 T 10 12	2F	Al	12	36,35	42	28	21	31	6	208	0,08
31 T 10 14	2F	Al	14	42,70	48	32	21	31	8	210	0,10
31 T 10 15	2F	Al	15	45,90	51	32	21	31	8	211	0,12
31 T 10 16	2F	Al	16	49,10	54	35	21	31	8	212	0,13
31 T 10 18	2F	Al	18	55,45	60	40	21	31	8	214	0,17
31 T 10 19	2F	Al	19	58,65	66	44	21	31	8	216	0,18
31 T 10 20	2F	Al	20	61,80	66	46	21	31	8	216	0,21
31 T 10 22	2F	Al	22	68,20	75	52	21	31	8	218	0,25
31 T 10 24	2F	Al	24	74,55	83	58	21	31	8	219	0,29
31 T 10 25	2F	Al	25	77,75	83	60	21	31	8	219	0,31
31 T 10 26	2F	Al	26	80,90	87	60	21	31	8	220	0,36
31 T 10 27	2F	Al	27	84,10	91	60	21	31	8	221	0,37
31 T 10 28	2F	Al	28	87,25	93	60	21	31	8	222	0,40
31 T 10 30	2F	Al	30	93,65	97	60	21	31	8	223	0,44
31 T 10 32	2F	Al	32	100,00	106	65	21	31	10	224	0,49
31 T 10 36	2F	Al	36	112,75	119	70	21	31	10	225	0,62
31 T 10 40	2F	Al	40	125,45	131	80	21	31	10	226	0,77
31 T 10 44	2	Al	44	138,20		88	21	31	10		1,00
31 T 10 48	2	Al	48	150,95		95	21	31	16		1,10
31 T 10 60	2	Al	60	189,15		110	21	31	16		1,70

PULEGGE DENTATE PASSO METRICO SERIE "T" - DIN 7721-2

METRIC PULLEYS "T" - DIN 7721-2

T 10
PASSO 10 mm
 PER CINGHIA LARGHEZZA 25 mm

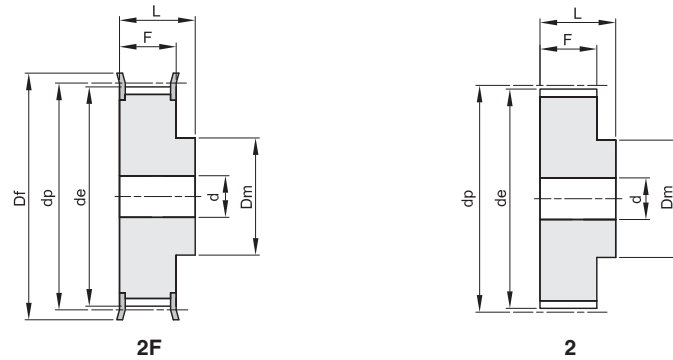

Materiale: Alluminio UNI 9006 - T6 (Al)
 adatto per l'ossidazione dura a spessore

codice	tipo	materiale	denti	de	Df	Dm	F	L	d	n° flangia	Kg.
40 T 10 12	2F	Al	12	36,35	42	28	30	40	6	208	0,10
40 T 10 14	2F	Al	14	42,70	48	32	30	40	8	210	0,13
40 T 10 15	2F	Al	15	45,90	51	32	30	40	8	211	0,15
40 T 10 16	2F	Al	16	49,10	54	35	30	40	8	212	0,18
40 T 10 18	2F	Al	18	55,45	60	40	30	40	8	214	0,22
40 T 10 19	2F	Al	19	58,65	66	44	30	40	8	216	0,25
40 T 10 20	2F	Al	20	61,80	66	46	30	40	8	216	0,28
40 T 10 22	2F	Al	22	68,20	75	52	30	40	8	218	0,34
40 T 10 24	2F	Al	24	74,55	83	58	30	40	8	219	0,39
40 T 10 25	2F	Al	25	77,75	83	60	30	40	8	219	0,42
40 T 10 26	2F	Al	26	80,90	87	60	30	40	8	220	0,48
40 T 10 27	2F	Al	27	84,10	91	60	30	40	8	221	0,54
40 T 10 28	2F	Al	28	87,25	93	60	30	40	8	222	0,55
40 T 10 30	2F	Al	30	93,65	97	60	30	40	8	223	0,64
40 T 10 32	2F	Al	32	100,00	106	65	30	40	10	224	0,69
40 T 10 36	2F	Al	36	112,75	119	70	30	40	10	225	0,87
40 T 10 40	2F	Al	40	125,45	131	80	30	40	10	226	1,07
40 T 10 44	2	Al	44	138,20		88	30	40	10		1,35
40 T 10 48	2	Al	48	150,95		95	30	40	16		1,52
40 T 10 60	2	Al	60	189,15		110	30	40	16		2,34

PULEGGE DENTATE PASSO METRICO SERIE "T" - DIN 7721-2

METRIC PULLEYS "T" - DIN 7721-2

T 10
PASSO 10 mm
 PER CINGHIA LARGHEZZA 32 mm

Materiale: Alluminio UNI 9006 - T6 (Al)
 adatto per l'ossidazione dura a spessore

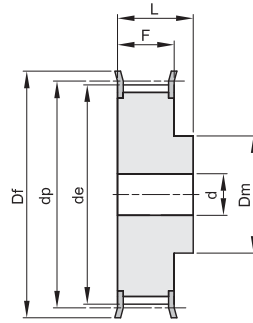

2F

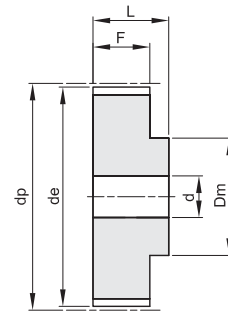

2

codice	tipo	materiale	dent	de	Df	Dm	F	L	d	n° flangia	Kg.
47 T 10 18	2F	Al	18	55,45	60	40	37	47	10	214	0,25
47 T 10 19	2F	Al	19	58,65	66	44	37	47	10	216	0,29
47 T 10 20	2F	Al	20	61,80	66	46	37	47	12	216	0,32
47 T 10 22	2F	Al	22	68,20	75	52	37	47	12	218	0,39
47 T 10 24	2F	Al	24	74,55	83	58	37	47	12	219	0,47
47 T 10 25	2F	Al	25	77,75	83	60	37	47	12	219	0,53
47 T 10 26	2F	Al	26	80,90	87	60	37	47	12	220	0,56
47 T 10 27	2F	Al	27	84,10	91	60	37	47	12	221	0,60
47 T 10 28	2F	Al	28	87,25	93	60	37	47	12	222	0,64
47 T 10 30	2F	Al	30	93,65	97	60	37	47	12	223	0,74
47 T 10 32	2F	Al	32	100,00	106	65	37	47	12	224	0,84
47 T 10 36	2F	Al	36	112,75	119	70	37	47	16	225	1,06
47 T 10 40	2F	Al	40	125,45	131	80	37	47	16	226	1,32
47 T 10 44	2	Al	44	138,20		88	37	47	16		1,61
47 T 10 48	2	Al	48	150,95		95	37	47	16		1,93
47 T 10 60	2	Al	60	189,10		110	37	47	16		3,00

PULEGGE DENTATE PASSO METRICO SERIE "T" - DIN 7721-2

METRIC PULLEYS "T" - DIN 7721-2

T 10
PASSO 10 mm
 PER CINGHIA LARGHEZZA 50 mm

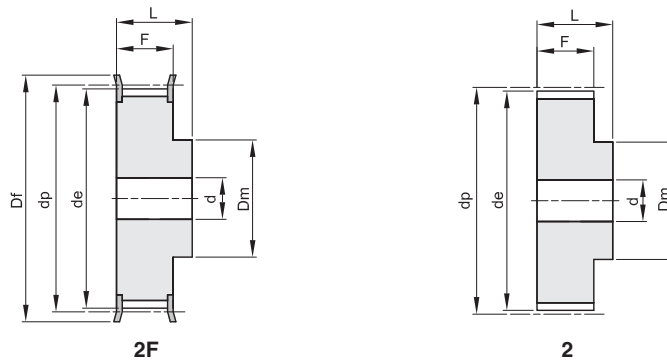

Materiale: Alluminio UNI 9006 - T6 (Al)
 adatto per l'ossidazione dura a spessore

codice	tipo	materiale	denti	de	Df	Dm	F	L	d	n° flangia	Kg.
66 T 10 18	2F	Al	18	55,45	60	40	56	66	10	214	0,42
66 T 10 19	2F	Al	19	58,65	66	44	56	66	10	216	0,47
66 T 10 20	2F	Al	20	61,80	66	46	56	66	12	216	0,52
66 T 10 22	2F	Al	22	68,20	75	52	56	66	12	218	0,57
66 T 10 24	2F	Al	24	74,55	83	58	56	66	12	219	0,74
66 T 10 25	2F	Al	25	77,75	83	60	56	66	12	219	0,77
66 T 10 26	2F	Al	26	80,90	87	60	56	66	12	220	0,82
66 T 10 27	2F	Al	27	84,10	91	60	56	66	12	221	0,95
66 T 10 28	2F	Al	28	87,25	93	60	56	66	12	222	0,96
66 T 10 30	2F	Al	30	93,65	97	60	56	66	12	223	1,17
66 T 10 32	2F	Al	32	100,00	106	65	56	66	12	224	1,30
66 T 10 36	2F	Al	36	112,75	119	70	56	66	16	225	1,64
66 T 10 40	2F	Al	40	125,45	131	80	56	66	16	226	2,00
66 T 10 44	2	Al	44	138,20		88	56	66	16		2,36
66 T 10 48	2	Al	48	150,95		95	56	66	16		2,83
66 T 10 60	2	Al	60	189,10		110	56	66	16		4,37

PULEGGE DENTATE PASSO METRICO SERIE BAT PER CINGHIE "AT" METRIC PULLEYS "AT"

BAT 5

PASSO 5 mm

PER CINGHIA AT LARGHEZZA 10 mm

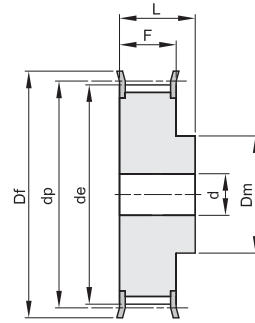

2F

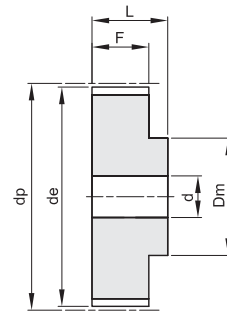

2

Materiale: Alluminio UNI 9006 - T6 (Al)
adatto per l'ossidazione dura a spessore

codice	tipo	materiale	denti	de	Df	Dm	F	L	d	n° flangia	Kg.
21 BAT 5 12	2F	Al	12	17,85	23	10	15	21		201	0,01
21 BAT 5 14	2F	Al	14	21,05	25	13	15	21		203	0,02
21 BAT 5 15	2F	Al	15	22,65	28	16	15	21		204	0,02
21 BAT 5 16	2F	Al	16	24,20	32	18	15	21		205	0,03
21 BAT 5 18	2F	Al	18	27,40	32	20	15	21		205	0,03
21 BAT 5 19	2F	Al	19	29,00	36	22	15	21		206	0,04
21 BAT 5 20	2F	Al	20	30,60	36	23	15	21		206	0,04
21 BAT 5 22	2F	Al	22	33,85	38	24	15	21		207	0,05
21 BAT 5 24	2F	Al	24	37,00	42	26	15	21		208	0,06
21 BAT 5 25	2F	Al	25	38,55	44	26	15	21		209	0,06
21 BAT 5 26	2F	Al	26	40,20	44	26	15	21		209	0,06
21 BAT 5 27	2F	Al	27	41,80	48	30	15	21	8	210	0,07
21 BAT 5 28	2F	Al	28	43,35	48	32	15	21	8	210	0,07
21 BAT 5 30	2F	Al	30	46,55	51	34	15	21	8	211	0,07
21 BAT 5 32	2F	Al	32	49,70	54	38	15	21	8	212	0,09
21 BAT 5 36	2F	Al	36	56,05	63	38	15	21	8	215	0,11
21 BAT 5 40	2F	Al	40	62,45	66	40	15	21	8	216	0,14
21 BAT 5 42	2F	Al	42	65,60	71	40	15	21	8	217	0,18
21 BAT 5 44	2	Al	44	68,80		45	15	21	8		0,18
21 BAT 5 48	2	Al	48	75,15		50	15	21	8		0,20
21 BAT 5 60	2	Al	60	94,25		65	15	21	8		0,31

PULEGGE DENTATE PASSO METRICO SERIE BAT PER CINGHIE "AT" METRIC PULLEYS "AT"

BAT 5
PASSO 5 mm
PER CINGHIA AT LARGHEZZA 16 mm

Materiale: Alluminio UNI 9006 - T6 (Al)
adatto per l'ossidazione dura a spessore

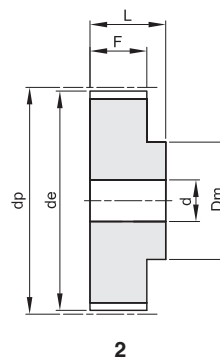
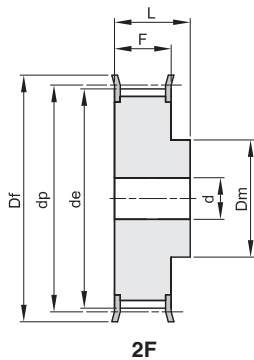

codice	tipo	materiale	denti	de	Df	Dm	F	L	d	n° flangia	Kg.
27 BAT 5 12	2F	Al	12	17,85	23	10	21	27		201	0,02
27 BAT 5 14	2F	Al	14	21,05	25	13	21	27		203	0,03
27 BAT 5 15	2F	Al	15	22,65	28	16	21	27		204	0,03
27 BAT 5 16	2F	Al	16	24,20	32	18	21	27		205	0,04
27 BAT 5 18	2F	Al	18	27,40	32	20	21	27		205	0,04
27 BAT 5 19	2F	Al	19	29,00	36	22	21	27		206	0,05
27 BAT 5 20	2F	Al	20	30,60	36	23	21	27		206	0,06
27 BAT 5 22	2F	Al	22	33,85	38	24	21	27		207	0,06
27 BAT 5 24	2F	Al	24	37,00	42	26	21	27		208	0,08
27 BAT 5 25	2F	Al	25	38,55	44	26	21	27		209	0,08
27 BAT 5 26	2F	Al	26	40,20	44	26	21	27		209	0,09
27 BAT 5 27	2F	Al	27	41,80	48	30	21	27	8	210	0,09
27 BAT 5 28	2F	Al	28	43,35	48	32	21	27	8	210	0,09
27 BAT 5 30	2F	Al	30	46,55	51	34	21	27	8	211	0,10
27 BAT 5 32	2F	Al	32	49,70	54	38	21	27	8	212	0,12
27 BAT 5 36	2F	Al	36	56,05	63	38	21	27	8	215	0,16
27 BAT 5 40	2F	Al	40	62,45	66	40	21	27	8	216	0,19
27 BAT 5 42	2F	Al	42	65,60	71	40	21	27	8	217	0,20
27 BAT 5 44	2	Al	44	68,80		45	21	27	8		0,23
27 BAT 5 48	2	Al	48	75,15		50	21	27	8		0,28
27 BAT 5 60	2	Al	60	94,25		65	21	27	8		0,43

PULEGGE DENTATE PASSO METRICO SERIE BAT PER CINGHIE "AT" METRIC PULLEYS "AT"

BAT 5

PASSO 5 mm

PER CINGHIA AT LARGHEZZA 25 mm

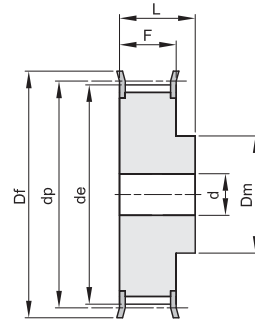

2F

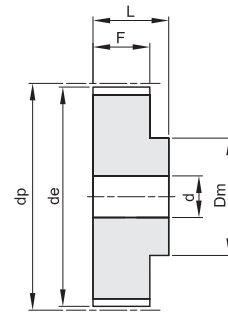

2

Materiale: Alluminio UNI 9006 - T6 (Al)
adatto per l'ossidazione dura a spessore

codice	tipo	materiale	denti	de	Df	Dm	F	L	d	n° flangia	Kg.
36 BAT 5 12	2F	Al	12	17,85	23	10	30	36		201	0,03
36 BAT 5 14	2F	Al	14	21,05	25	13	30	36		203	0,04
36 BAT 5 15	2F	Al	15	22,65	28	16	30	36		204	0,04
36 BAT 5 16	2F	Al	16	24,20	32	18	30	36		205	0,05
36 BAT 5 18	2F	Al	18	27,40	32	20	30	36		205	0,06
36 BAT 5 19	2F	Al	19	29,00	36	22	30	36		206	0,07
36 BAT 5 20	2F	Al	20	30,60	36	23	30	36		206	0,08
36 BAT 5 22	2F	Al	22	33,85	38	24	30	36		207	0,08
36 BAT 5 24	2F	Al	24	37,00	42	26	30	36	8	208	0,11
36 BAT 5 25	2F	Al	25	38,55	44	26	30	36	8	209	0,12
36 BAT 5 26	2F	Al	26	40,20	44	26	30	36	8	209	0,12
36 BAT 5 27	2F	Al	27	41,80	48	30	30	36	8	210	0,13
36 BAT 5 28	2F	Al	28	43,35	48	32	30	36	8	210	0,14
36 BAT 5 30	2F	Al	30	46,55	51	34	30	36	8	211	0,15
36 BAT 5 32	2F	Al	32	49,70	54	38	30	36	8	212	0,18
36 BAT 5 36	2F	Al	36	56,05	63	38	30	36	8	215	0,23
36 BAT 5 40	2F	Al	40	62,45	66	40	30	36	8	216	0,28
36 BAT 5 42	2F	Al	42	65,60	71	40	30	36	8	217	0,29
36 BAT 5 44	2	Al	44	68,80		45	30	36	8		0,31
36 BAT 5 48	2	Al	48	75,15		50	30	36	8		0,40
36 BAT 5 60	2	Al	60	94,25		65	30	36	8		0,61

PULEGGE DENTATE PASSO METRICO SERIE BAT PER CINGHIE "AT" METRIC PULLEYS "AT"

BAT 10
PASSO 10 mm
PER CINGHIA AT LARGHEZZA 16 mm

Materiale: Alluminio UNI 9006 - T6 (Al)
adatto per l'ossidazione dura a spessore

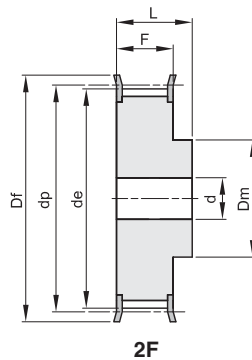

2F

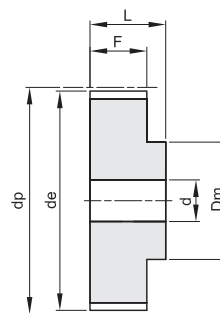

2

codice	tipo	materiale	denti	de	Df	Dm	F	L	d	n° flangia	Kg.
31 BAT 10 15	2F	Al	15	45,90	51	32	21	31	8	211	0,12
31 BAT 10 16	2F	Al	16	49,10	54	35	21	31	8	212	0,13
31 BAT 10 18	2F	Al	18	55,45	60	40	21	31	8	214	0,17
31 BAT 10 19	2F	Al	19	58,65	66	44	21	31	8	216	0,18
31 BAT 10 20	2F	Al	20	61,80	66	46	21	31	8	216	0,21
31 BAT 10 22	2F	Al	22	68,20	75	52	21	31	8	218	0,25
31 BAT 10 24	2F	Al	24	74,55	83	58	21	31	8	219	0,29
31 BAT 10 25	2F	Al	25	77,75	83	60	21	31	8	219	0,31
31 BAT 10 26	2F	Al	26	80,90	87	60	21	31	8	220	0,36
31 BAT 10 27	2F	Al	27	84,05	91	60	21	31	8	221	0,37
31 BAT 10 28	2F	Al	28	87,25	93	60	21	31	8	222	0,40
31 BAT 10 30	2F	Al	30	93,65	97	60	21	31	8	223	0,44
31 BAT 10 32	2F	Al	32	100,00	106	65	21	31	10	224	0,49
31 BAT 10 36	2F	Al	36	112,75	119	70	21	31	10	225	0,62
31 BAT 10 40	2F	Al	40	125,45	131	80	21	31	10	226	0,77
31 BAT 10 44	2	Al	44	138,20		88	21	31	10		1,00
31 BAT 10 48	2	Al	48	150,95		95	21	31	16		1,10
31 BAT 10 60	2	Al	60	189,15		110	21	31	16		1,70

PULEGGE DENTATE PASSO METRICO SERIE BAT PER CINGHIE "AT" METRIC PULLEYS "AT"

BAT 10
PASSO 10 mm
PER CINGHIA AT LARGHEZZA 25 mm

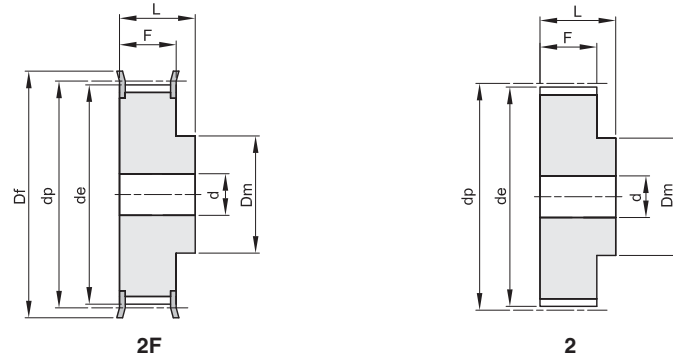

Materiale: Alluminio UNI 9006 - T6 (Al)
adatto per l'ossidazione dura a spessore

codice	tipo	materiale	denti	de	Df	Dm	F	L	d	n° flangia	Kg.
40 BAT 10 15	2F	Al	15	45,90	51	32	30	40	8	211	0,15
40 BAT 10 16	2F	Al	16	49,10	54	35	30	40	8	212	0,18
40 BAT 10 18	2F	Al	18	55,45	60	40	30	40	8	214	0,22
40 BAT 10 19	2F	Al	19	58,65	66	44	30	40	8	216	0,25
40 BAT 10 20	2F	Al	20	61,80	66	46	30	40	8	216	0,28
40 BAT 10 22	2F	Al	22	68,20	75	52	30	40	8	218	0,34
40 BAT 10 24	2F	Al	24	74,55	83	58	30	40	8	219	0,39
40 BAT 10 25	2F	Al	25	77,75	83	60	30	40	8	219	0,42
40 BAT 10 26	2F	Al	26	80,90	87	60	30	40	8	220	0,48
40 BAT 10 27	2F	Al	27	84,05	91	60	30	40	8	221	0,54
40 BAT 10 28	2F	Al	28	87,25	93	60	30	40	8	222	0,55
40 BAT 10 30	2F	Al	30	93,65	97	60	30	40	8	223	0,64
40 BAT 10 32	2F	Al	32	100,00	106	65	30	40	10	224	0,69
40 BAT 10 36	2F	Al	36	112,75	119	70	30	40	10	225	0,87
40 BAT 10 40	2F	Al	40	125,45	131	80	30	40	10	226	1,07
40 BAT 10 44	2	Al	44	138,20		88	30	40	10		1,35
40 BAT 10 48	2	Al	48	150,95		95	30	40	16		1,52
40 BAT 10 60	2	Al	60	189,15		110	30	40	16		2,34

PULEGGE DENTATE PASSO METRICO SERIE BAT PER CINGHIE "AT" METRIC PULLEYS "AT"

BAT 10
PASSO 10 mm
PER CINGHIA AT LARGHEZZA 32 mm

Materiale: Alluminio UNI 9006 - T6 (Al)
adatto per l'ossidazione dura a spessore

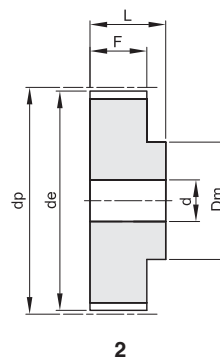
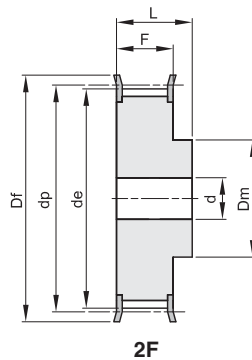

codice	tipo	materiale	denti	de	Df	Dm	F	L	d	n° flangia	Kg.
47 BAT 10 18	2F	Al	18	55,45	60	40	37	47	10	214	0,25
47 BAT 10 19	2F	Al	19	58,65	66	44	37	47	10	216	0,29
47 BAT 10 20	2F	Al	20	61,80	66	46	37	47	12	216	0,32
47 BAT 10 22	2F	Al	22	68,20	75	52	37	47	12	218	0,39
47 BAT 10 24	2F	Al	24	74,55	83	58	37	47	12	219	0,47
47 BAT 10 25	2F	Al	25	77,75	83	60	37	47	12	219	0,53
47 BAT 10 26	2F	Al	26	80,90	87	60	37	47	12	220	0,56
47 BAT 10 27	2F	Al	27	84,05	91	60	37	47	12	221	0,60
47 BAT 10 28	2F	Al	28	87,25	93	60	37	47	12	222	0,64
47 BAT 10 30	2F	Al	30	93,65	97	60	37	47	12	223	0,74
47 BAT 10 32	2F	Al	32	100,00	106	65	37	47	12	224	0,84
47 BAT 10 36	2F	Al	36	112,75	119	70	37	47	16	225	1,06
47 BAT 10 40	2F	Al	40	125,45	131	80	37	47	16	226	1,32
47 BAT 10 44	2	Al	44	138,20		88	37	47	16		1,61
47 BAT 10 48	2	Al	48	150,95		95	37	47	16		1,93
47 BAT 10 60	2	Al	60	189,15		110	37	47	16		3,00

PULEGGE DENTATE PASSO METRICO SERIE BAT PER CINGHIE "AT" METRIC PULLEYS "AT"

BAT 10
PASSO 10 mm
PER CINGHIA AT LARGHEZZA 50 mm

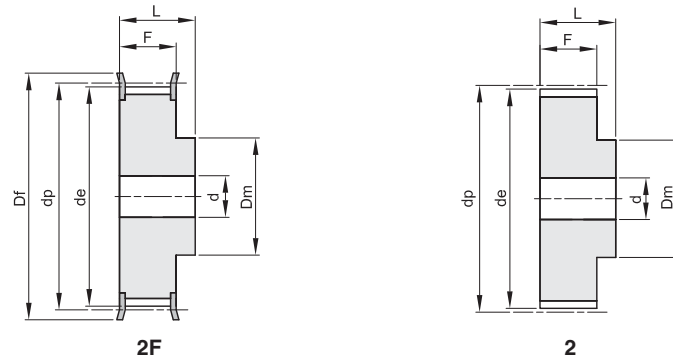

Materiale: Alluminio UNI 9006 - T6 (Al)
adatto per l'ossidazione dura a spessore

codice	tipo	materiale	denti	de	Df	Dm	F	L	d	n° flangia	Kg.
66 BAT 10 18	2F	Al	18	55,45	60	40	56	66	10	214	0,42
66 BAT 10 19	2F	Al	19	58,65	66	44	56	66	10	216	0,47
66 BAT 10 20	2F	Al	20	61,80	66	46	56	66	12	216	0,52
66 BAT 10 22	2F	Al	22	68,20	75	52	56	66	12	218	0,57
66 BAT 10 24	2F	Al	24	74,55	83	58	56	66	12	219	0,74
66 BAT 10 25	2F	Al	25	77,75	83	60	56	66	12	219	0,77
66 BAT 10 26	2F	Al	26	80,90	87	60	56	66	12	220	0,82
66 BAT 10 27	2F	Al	27	84,05	91	60	56	66	12	221	0,95
66 BAT 10 28	2F	Al	28	87,25	93	60	56	66	12	222	0,96
66 BAT 10 30	2F	Al	30	93,65	97	60	56	66	12	223	1,17
66 BAT 10 32	2F	Al	32	100,00	106	65	56	66	12	224	1,30
66 BAT 10 36	2F	Al	36	112,75	119	70	56	66	16	225	1,64
66 BAT 10 40	2F	Al	40	125,45	131	80	56	66	16	226	2,00
66 BAT 10 44	2	Al	44	138,20		88	56	66	16		2,36
66 BAT 10 48	2	Al	48	150,95		95	56	66	16		2,83
66 BAT 10 60	2	Al	60	189,15		110	56	66	16		4,37

BARRE DENTATE PER CINGHIE POSITIVE SYNCHROBELT® - ISO 5294

TIMING BELT BARS - ISO 5294

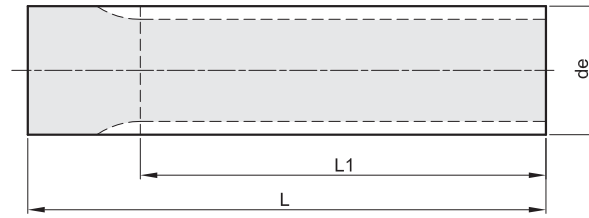

MXL PASSO 0,080" (2,032 mm)

MATERIALE: ALLUMINIO UNI 9006 - T6

codice	Z	de	L1	L	Kg.
MXL 12	12	7,25	50	75	0,01
MXL 14	14	8,55	50	75	0,01
MXL 15	15	9,19	50	75	0,01
MXL 16	16	9,84	50	75	0,02
MXL 18	18	11,13	50	75	0,02
MXL 20	20	12,43	90	120	0,04
MXL 22	22	13,72	125	140	0,05
MXL 24	24	15,02	125	140	0,06
MXL 25	25	15,66	125	140	0,07
MXL 26	26	16,31	125	140	0,08
MXL 28	28	17,60	125	140	0,09
MXL 30	30	18,90	125	140	0,10
MXL 32	32	20,19	125	140	0,12
MXL 34	34	21,48	125	140	0,13
MXL 36	36	22,78	140	140	0,15
MXL 38	38	24,07	140	140	0,17
MXL 40	40	25,36	140	140	0,19
MXL 42	42	26,66	140	140	0,20
MXL 44	44	27,95	140	140	0,23
MXL 45	45	28,60	140	140	0,24
MXL 48	48	30,54	140	140	0,27
MXL 50	50	31,83	140	140	0,30
MXL 60	60	38,30	160	160	0,49
MXL 70	70	44,77	160	160	0,67
MXL 72	72	46,06	160	160	0,72

XL PASSO 1/5" (5,08 mm)

MATERIALE: ALLUMINIO UNI 9006 - T6

codice	Z	de	L1	L	Kg.
XL 10	10	15,66	140	140	0,07
XL 11	11	17,28	140	140	0,08
XL 12	12	18,90	140	140	0,10
XL 13	13	20,51	140	140	0,11
XL 14	14	22,13	140	140	0,13
XL 15	15	23,75	140	140	0,16
XL 16	16	25,36	140	140	0,18
XL 17	17	26,98	140	140	0,20
XL 18	18	28,60	140	140	0,23
XL 19	19	30,22	140	140	0,26
XL 20	20	31,83	140	140	0,28
XL 21	21	33,45	160	160	0,36
XL 22	22	35,07	160	160	0,40
XL 23	23	36,60	160	160	0,44
XL 24	24	38,30	160	160	0,48
XL 25	25	39,92	160	160	0,51
XL 26	26	41,53	160	160	0,56
XL 27	27	43,15	160	160	0,60
XL 28	28	44,77	160	160	0,65
XL 29	29	46,39	160	160	0,70
XL 30	30	48,00	160	160	0,75
XL 32	32	51,24	160	160	0,87
XL 33	33	52,85	160	160	0,92
XL 34	34	54,47	160	160	0,98
XL 35	35	56,09	160	160	1,04
XL 36	36	57,70	160	160	1,10
XL 38	38	60,94	160	160	1,23
XL 39	39	62,56	160	160	1,30
XL 40	40	64,17	160	160	1,37
XL 41	41	65,79	160	160	1,43
XL 42	42	67,41	160	160	1,51
XL 43	43	69,02	160	160	1,58
XL 44	44	70,64	160	160	1,65
XL 48	48	77,11	160	160	1,98
XL 56	56	90,04	160	160	2,71
XL 60	60	96,51	160	160	3,10
XL 72	72	115,92	160	160	4,52

L PASSO 3/8" (9,525 mm)

MATERIALE: ALLUMINIO UNI 9006 - T6

codice	Z	de	L1	L	Kg.
L 10	10	29,56	140	140	0,23
L 11	11	32,59	140	140	0,28
L 12	12	35,62	160	160	0,39
L 13	13	38,65	160	160	0,46
L 14	14	41,68	160	160	0,55
L 15	15	44,72	160	160	0,63
L 16	16	47,75	160	160	0,73
L 17	17	50,78	160	160	0,82
L 18	18	53,81	160	160	0,93
L 19	19	56,84	160	160	1,04
L 20	20	59,88	160	160	1,16
L 21	21	62,91	160	160	1,28
L 22	22	65,94	160	160	1,41
L 23	23	68,97	160	160	1,55
L 24	24	72,00	160	160	1,69
L 27	27	81,10	160	160	2,15
L 30	30	90,20	160	160	2,67

L PASSO 3/8" (9,525 mm)

MATERIALE: ACCIAIO

codice	Z	de	L1	L	Kg.
L 10	10	29,56	140	140	0,66
L 11	11	32,59	140	140	0,81
L 12	12	35,62	160	160	1,12
L 13	13	38,65	160	160	1,32
L 14	14	41,68	160	160	1,57
L 15	15	44,72	160	160	1,81
L 16	16	47,75	160	160	2,08
L 17	17	50,78	160	160	2,34
L 18	18	53,81	160	160	2,64
L 19	19	56,84	160	160	2,96
L 20	20	59,88	160	160	3,32
L 21	21	62,91	160	160	3,67
L 22	22	65,94	160	160	4,07
L 23	23	68,97	160	160	4,44
L 24	24	72,00	160	160	4,86
L 27	27	81,10	160	160	6,20
L 30	30	90,20	160	160	7,72

BARRE DENTATE PER CINGHIE SYNCHROBELT® - "HTD"

TIMING BELT BARS "HTD"

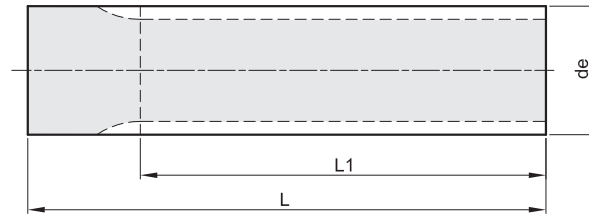

HTD 5M PASSO 5 mm

MATERIALE: ALLUMINIO UNI 9006 - T6

codice	Z	de	L1	L	Kg.
5M 12	12	17,96	160	160	0,08
5M 13	13	19,55	160	160	0,10
5M 14	14	21,14	175	200	0,16
5M 15	15	22,73	175	200	0,19
5M 16	16	24,32	175	200	0,21
5M 17	17	25,92	175	200	0,24
5M 18	18	27,51	200	200	0,27
5M 19	19	29,10	200	200	0,31
5M 20	20	30,69	200	200	0,35
5M 21	21	32,28	200	200	0,39
5M 22	22	33,87	200	200	0,43
5M 23	23	35,47	200	200	0,48
5M 24	24	37,06	200	200	0,52
5M 25	25	38,65	200	200	0,57
5M 26	26	40,24	200	200	0,62
5M 27	27	41,83	200	200	0,67
5M 28	28	43,42	200	200	0,73
5M 30	30	46,61	200	200	0,84
5M 32	32	49,79	200	200	0,97
5M 34	34	52,97	200	200	1,11
5M 36	36	56,16	200	200	1,25
5M 38	38	59,34	200	200	1,40
5M 40	40	62,52	200	200	1,55
5M 42	42	65,71	200	200	1,73
5M 44	44	68,89	200	200	1,90
5M 45	45	70,48	200	200	1,99
5M 48	48	75,25	200	200	2,27
5M 50	50	78,44	200	200	2,48
5M 60	60	94,35	200	200	3,60
5M 72	72	113,45	200	200	5,28

HTD 8M PASSO 8 mm

MATERIALE: ACCIAIO

codice	Z	de	L1	L	Kg.
8M 18	18	44,47	200	200	2,03
8M 19	19	47,01	200	200	2,30
8M 20	20	49,56	200	200	2,57
8M 21	21	52,11	200	200	2,88
8M 22	22	54,65	200	200	3,18
8M 23	23	57,20	200	200	3,52
8M 24	24	59,75	200	200	3,86
8M 25	25	62,29	200	200	4,23
8M 26	26	64,84	200	200	4,60
8M 28	28	69,93	200	200	5,40
8M 30	30	75,02	200	200	6,27
8M 32	32	80,12	200	200	7,20
8M 34	34	85,21	200	200	8,20
8M 35	35	87,76	200	200	8,71
8M 36	36	90,30	200	200	9,26
8M 38	38	95,40	200	200	10,39
8M 40	40	100,49	200	200	11,58
8M 44	44	110,68	200	200	14,16
8M 48	48	120,86	200	200	16,99

BARRE DENTATE PASSO METRICO SERIE "T" - DIN 7721-2

METRIC BARS "T" - DIN 7721-2

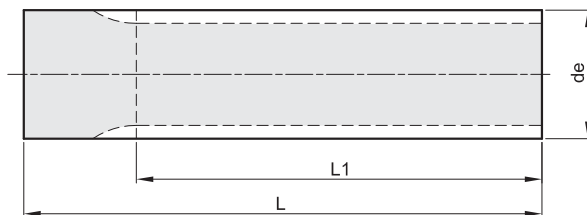

T 2,5 PASSO 2,5 mm

MATERIALE: ALLUMINIO UNI 9006 - T6

codice	Z	de	L1	L	Kg.
T 2,5 10	10	7,42	50	75	0,01
T 2,5 12	12	9,00	50	75	0,01
T 2,5 13	13	9,80	50	75	0,02
T 2,5 14	14	10,60	50	75	0,02
T 2,5 15	15	11,40	75	75	0,02
T 2,5 16	16	12,20	75	75	0,02
T 2,5 17	17	13,00	75	75	0,03
T 2,5 18	18	13,80	75	75	0,03
T 2,5 19	19	14,60	120	120	0,05
T 2,5 20	20	15,40	120	120	0,05
T 2,5 21	21	16,20	120	120	0,06
T 2,5 22	22	17,00	140	140	0,08
T 2,5 24	24	18,55	140	140	0,09
T 2,5 26	26	20,15	140	140	0,12
T 2,5 27	27	20,95	140	140	0,13
T 2,5 28	28	21,75	140	140	0,14
T 2,5 29	29	22,55	140	140	0,15
T 2,5 30	30	23,35	140	140	0,15
T 2,5 32	32	24,95	140	140	0,18
T 2,5 34	34	26,55	140	140	0,21
T 2,5 35	35	27,35	140	140	0,21
T 2,5 36	36	28,10	140	140	0,22
T 2,5 38	38	29,70	140	140	0,26
T 2,5 40	40	31,30	140	140	0,27
T 2,5 42	42	32,90	140	140	0,32
T 2,5 44	44	34,50	140	140	0,33
T 2,5 45	45	35,30	140	140	0,37
T 2,5 48	48	37,70	140	140	0,40
T 2,5 50	50	39,29	160	160	0,52
T 2,5 60	60	47,25	160	160	0,72
T 2,5 65	65	51,20	160	160	0,87
T 2,5 70	70	55,20	160	160	1,05
T 2,5 72	72	56,80	160	160	1,11
T 2,5 90	90	71,12	160	160	1,75
T 2,5 100	100	79,08	160	160	2,18

T 5 PASSO 5 mm

MATERIALE: ALLUMINIO UNI 9006 - T6

codice	Z	de	L1	L	Kg.
T 5 10	10	15,05	140	140	0,06
T 5 11	11	16,65	140	140	0,07
T 5 12	12	18,25	140	140	0,09
T 5 13	13	19,85	140	140	0,10
T 5 14	14	21,45	140	140	0,12
T 5 15	15	23,05	140	140	0,14
T 5 16	16	24,60	140	140	0,16
T 5 17	17	26,20	140	140	0,19
T 5 18	18	27,80	140	140	0,21
T 5 19	19	29,40	140	140	0,24
T 5 20	20	31,00	160	160	0,31
T 5 21	21	32,70	160	160	0,33
T 5 22	22	34,25	160	160	0,36
T 5 23	23	35,85	160	160	0,39
T 5 24	24	37,40	160	160	0,43
T 5 25	25	38,95	160	160	0,47
T 5 26	26	40,60	160	160	0,51
T 5 27	27	42,20	160	160	0,55
T 5 28	28	43,75	160	160	0,60
T 5 29	29	45,35	160	160	0,65
T 5 30	30	46,95	160	160	0,70
T 5 32	32	50,10	160	160	0,80
T 5 34	34	53,25	160	160	0,91
T 5 35	35	54,85	160	160	0,98
T 5 36	36	56,45	160	160	1,02
T 5 37	37	58,06	160	160	1,08
T 5 38	38	59,65	160	160	1,14
T 5 40	40	62,85	160	160	1,27
T 5 42	42	66,00	160	160	1,41
T 5 44	44	69,20	160	160	1,55
T 5 45	45	70,80	160	160	1,63
T 5 46	46	72,40	160	160	1,69
T 5 48	48	75,55	160	160	1,85
T 5 50	50	78,75	160	160	2,02
T 5 60	60	94,65	160	160	2,95
T 5 72	72	113,75	160	160	4,28
T 5 80	80	126,48	160	160	5,39
T 5 90	90	142,40	160	160	6,76
T 5 100	100	158,31	160	160	8,34

T 10 PASSO 10 mm

MATERIALE: ALLUMINIO UNI 9006 - T6

codice	Z	de	L1	L	Kg.
T 10 10	10	29,98	140	140	0,22
T 10 11	11	33,16	140	140	0,29
T 10 12	12	36,35	140	140	0,34
T 10 13	13	39,55	140	140	0,42
T 10 14	14	42,70	160	160	0,55
T 10 15	15	45,90	160	160	0,64
T 10 16	16	49,10	160	160	0,74
T 10 17	17	52,25	160	160	0,85
T 10 18	18	55,45	160	160	0,96
T 10 19	19	58,65	160	160	1,07
T 10 20	20	61,80	160	160	1,20
T 10 21	21	65,00	160	160	1,29
T 10 22	22	68,20	160	160	1,43
T 10 23	23	71,35	160	160	1,58
T 10 24	24	74,55	160	160	1,73
T 10 26	26	80,90	160	160	2,05
T 10 28	28	87,25	160	160	2,39
T 10 30	30	93,65	160	160	2,76
T 10 32	32	100,00	160	160	3,18
T 10 34	34	106,40	160	160	3,61
T 10 36	36	112,75	160	160	4,06
T 10 38	38	119,10	160	160	4,62
T 10 40	40	125,45	160	160	5,13
T 10 45	45	141,40	160	160	6,50
T 10 48	48	150,95	160	160	7,39
T 10 60	60	189,15	160	160	11,76
T 10 72	72	227,29	160	160	17,03

BARRE DENTATE PASSO METRICO SERIE BAT PER CINGHIE "AT"

METRIC BARS "AT"

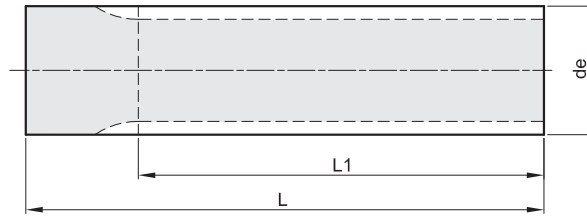

BAT 5 PASSO 5 mm

MATERIALE: ALLUMINIO UNI 9006 - T6

BAT 10 PASSO 10 mm

MATERIALE: ALLUMINIO UNI 9006 - T6

codice	Z	de	L1	L	Kg.
BAT 5 12	12	17,85	140	140	0,08
BAT 5 13	13	19,45	140	140	0,10
BAT 5 14	14	21,05	140	140	0,12
BAT 5 15	15	22,65	140	140	0,14
BAT 5 16	16	24,20	140	140	0,15
BAT 5 17	17	25,80	140	140	0,18
BAT 5 18	18	27,40	140	140	0,20
BAT 5 19	19	29,00	140	140	0,23
BAT 5 20	20	30,60	160	160	0,30
BAT 5 21	21	32,30	160	160	0,33
BAT 5 22	22	33,85	160	160	0,36
BAT 5 23	23	35,45	160	160	0,40
BAT 5 24	24	37,00	160	160	0,44
BAT 5 25	25	38,55	160	160	0,47
BAT 5 26	26	40,20	160	160	0,51
BAT 5 27	27	41,80	160	160	0,55
BAT 5 28	28	43,35	160	160	0,60
BAT 5 30	30	46,55	160	160	0,69
BAT 5 32	32	49,70	160	160	0,81
BAT 5 34	34	52,85	160	160	0,90
BAT 5 36	36	56,05	160	160	1,02
BAT 5 38	38	59,25	160	160	1,14
BAT 5 40	40	62,45	160	160	1,28
BAT 5 42	42	65,60	160	160	1,41
BAT 5 44	44	68,80	160	160	1,55
BAT 5 46	46	72,00	160	160	1,70
BAT 5 48	48	75,15	160	160	1,85
BAT 5 52	52	81,55	160	160	2,19
BAT 5 56	56	87,90	160	160	2,55
BAT 5 58	58	91,10	160	160	2,74
BAT 5 60	60	94,25	160	160	2,94
BAT 5 64	64	100,65	160	160	3,36
BAT 5 72	72	113,35	160	160	4,29

codice	Z	de	L1	L	Kg.
BAT 10 15	15	45,90	160	160	0,62
BAT 10 16	16	49,10	160	160	0,72
BAT 10 17	17	52,25	160	160	0,82
BAT 10 18	18	55,45	160	160	0,94
BAT 10 19	19	58,65	160	160	1,05
BAT 10 20	20	61,80	160	160	1,17
BAT 10 21	21	65,00	160	160	1,31
BAT 10 22	22	68,20	160	160	1,44
BAT 10 23	23	71,35	160	160	1,60
BAT 10 24	24	74,55	160	160	1,75
BAT 10 25	25	77,75	160	160	1,91
BAT 10 26	26	80,90	160	160	2,06
BAT 10 27	27	84,05	160	160	2,23
BAT 10 28	28	87,25	160	160	2,42
BAT 10 30	30	93,65	160	160	2,79
BAT 10 32	32	100,00	160	160	3,20
BAT 10 34	34	106,40	160	160	3,65
BAT 10 36	36	112,75	160	160	4,09
BAT 10 38	38	119,10	160	160	4,59
BAT 10 40	40	125,45	160	160	5,16
BAT 10 42	42	131,85	160	160	5,65
BAT 10 44	44	138,20	160	160	6,22
BAT 10 46	46	144,55	160	160	6,84
BAT 10 48	48	150,95	160	160	7,45
BAT 10 52	52	163,65	160	160	8,93
BAT 10 56	56	176,40	160	160	10,39
BAT 10 58	58	182,75	160	160	10,96
BAT 10 60	60	189,15	160	160	11,78
BAT 10 70	70	220,95	160	160	16,18

DIMENSIONI FLANGE PER PULEGGE DENTATE - ZINCATE

PULLEYS FLANGES DIMENSIONS ZINC PLATED

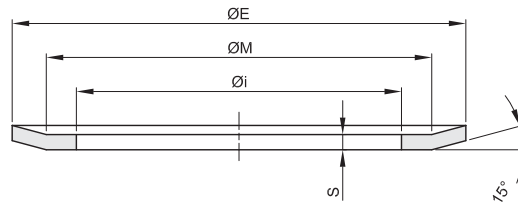

n° spessore S=0,5 mm				n° spessore S=1 mm				n° spessore S=1,5 mm				n° spessore S=2,5 mm			
flangia	Ø E	Ø M	Ø i	flangia	Ø E	Ø M	Ø i	flangia	Ø E	Ø M	Ø i	flangia	Ø E	Ø M	Ø i
100	13	10	6	200	19,5	17,5	12,5	300	36	31	25	400	127	120,2	104,7
101	15	12	8	201	23	17,5	12	301	38	34	28	401	138	130	108
102	16	13	9,5	202	23	20	14	302	42	38	30,5	402	146	138	116
104	18	15	11,5	203	25	22	15	303	44	40	33	403	154	146	122
105	19,5	17,5	12	204	28	24	18	304	48	43,5	37	404	160	150	128
106	23	17,5	12	205	32	28	21,5	305	51	47,5	40	405	168	162	135
107	23	20	14	206	36	31	25	306	54	50,5	43	406	183	170	145
108	25	22	15	207	38	34	28	307	57	53	46	407	188	180	158
109	28	24	18	208	42	38	30,5	308	60	57	47	409	198	188	165
110	32	28	21,5	209	44	40	33	309	63	57	48	410	200	192,8	172
111	36	31	25	210	48	43,5	37	310	66	61,5	52	411	211	198	173
112	38	34	28	211	51	47,5	40	311	71	65	56	412	226	214	190
113	42	38	30,5	212	54	50,5	43	312	75	68,5	60	414	240	224	192
114	48	43,5	37	213	57	53	46	313	79	73,5	64	415	256	240	220
				214	60	57	47	314	83	76,5	68	416	256	247	225
				215	63	57	48	315	87	82,5	72	418	296	287	252
				216	66	61,5	52	316	91	85,5	76				
				217	71	65	56	317	93	89	80				
				218	75	68,5	60	318	97	93	83				
				219	83	76,5	68	319	98	92	79,3				
				220	87	82,5	72	320	103	97	86				
				221	91	85,5	76	321	106	101	90				
				222	93	89	80	322	111	106	94				
				223	97	93	83	323	115	110	99				
				224	106	101	90	325	119	113,5	103				
				225	119	113,5	103	326	123	117,5	107				
				226	131	125,5	115	327	127	122	111				
								328	135	130	119				
								330	140	134,5	123				
								331	143	139	127				
								333	148	143	132				
								334	152	147,5	136				
								335	158	154	142				
								338	168	163	149,5				
								339	184	179	165				
								340	192	187	173				
								342	200	195	181				

CODICE NUMERICO FLANGE PER PULEGGE DENTATE

CODES OF FLANGES FOR TIMING PULLEYS

N° DENTI PULEGGIA	MXL SP 0,5	XL SP. 1	L SP. 1,5	H SP. 1,5	XH SP. 2,5	HTD 3M SP. 0,5	HTD 5M SP. 1	HTD 8M SP. 1,5	HTD 14M SP. 2,5	T 2,5 SP. 0,5	T 5 SP. 1	T 10 SP. 1	BAT 5 SP. 1	BAT 10 SP. 1
10		201	300			100					200	206		
11		201	301								201	207		
12	100	203	302			101	202			100	201	208	201	208
13		203	303				203			100	203	209	203	
14	100	204	304	309		102	203			101	203	210	203	210
15	100	204	305	310		104	204			101	204	211	204	211
16	101	205	306	311		104	204			102	205	212	205	212
17		205	307	312			205			104	205	213	205	213
18	102	206	308	313	401	105	205	304		104	205	214	205	214
19		206	309	314	402		205	305		104	206	216	206	216
20	102	207	310	315	403	107	206	306		105	206	216	206	216
21		207	311	316	404	108	207	307		105	207	217	207	217
22	104	208	312	317	405	108	207	308		106	207	218	207	218
23		208	313	318			208	309			208	313	208	313
24	104	209	313	320	406	108	208	310		107	208	219	208	219
25	105	210	314	321	407		209	310		107	209	219	209	219
26	106	210	315	322	409	109	209	311		108	209	220	209	220
27		210	315	323	410		210				210	221	210	221
28	107	211	316	325	411	110	210	312	400	108	210	222	210	222
29		211		326						109	211			
30	107	212	318	327	412	110	211	314	401	109	211	223	211	223
32	108	213	320	328	414	111	212	315	403	110	212	224	212	224
33		213	321	330										
34	108	214	322	331	415		213	316	404	110	213	323	213	323
35		215	322	333				317		110	214			
36	109	216	323	334		112	214	319	405	111	215	225	215	225
37											215			
38	109	217		335			216	320	406	111	216	327	216	327
39		217												
40	110	217	327	338		113	217	321	407	112	216	226	216	226
41		218												
42	110	218	328				218				217		217	330
43		313												
44	111	313	330	339		114	218	325	411	113	218		218	331
45	111		331	340			313			113	313	333		
46											313		313	334
48	111	220	334	342			219	327	412		219	335	219	335
50	112						220			209	220			
52													220	338
56		223					222	333	416				222	339
58													223	340
60	113	320					320			211	320	342	320	342
64							224	338	418					224
65										213				
70	211									215				
72	211	326					225	340		215	225		225	
80											226			
90										219	333			
100										220	338			

CINGHIE DENTATE POSITIVE SYNCHROBELT® - ISO 5296

TIMING BELTS - ISO 5296

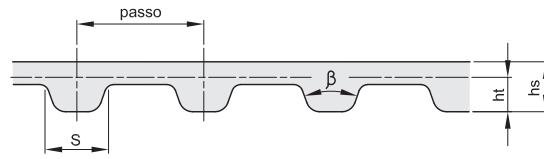

MATERIALE: NEOPRENE CON CAVI IN FIBRA DI VETRO

DIMENSIONAMENTO E TOLLERANZE SULLO SPESSORE

SIZES AND TOLERANCES OF THE THICKNESS

tipo	passo mm	hs mm	toll. mm	ht mm	S mm	β gradi
XL	5.080	2,3	±0,20	1,27	2,57	50
L	9.525	3,6	±0,25	1,91	4,65	40
H	12.700	4,3	±0,25	2,29	6,12	40
XH	22.225	11,2	±0,65	6,35	12,57	40

TOLLERANZE SULLE LARGHEZZE

WIDTH TOLERANCES

larghezza cinghia		tolleranza di larghezza sulla lunghezza primitiva		
in 1/100 di pollice	in mm	fino a 838,2 mm	> 838,2 fino a 1676,4 mm	> 1676,4 mm
0,12-0,37	3,0-9,5	+0,5 - 0,8	-	-
> 037-150	> 9,5-38,1	+0,8 - 0,8	+0,8 - 1,3	+0,8 - 1,3
> 150-200	> 38,1-50,8	+0,8 - 1,3	+1,3 - 1,3	+1,3 - 1,5
> 200-300	> 50,8-76,2	+1,3 - 1,5	+1,5 - 1,5	+1,5 - 2,0

SCELTA DEL PASSO DELLE CINGHIE DENTATE

BELT PITCH SELECTION CHART

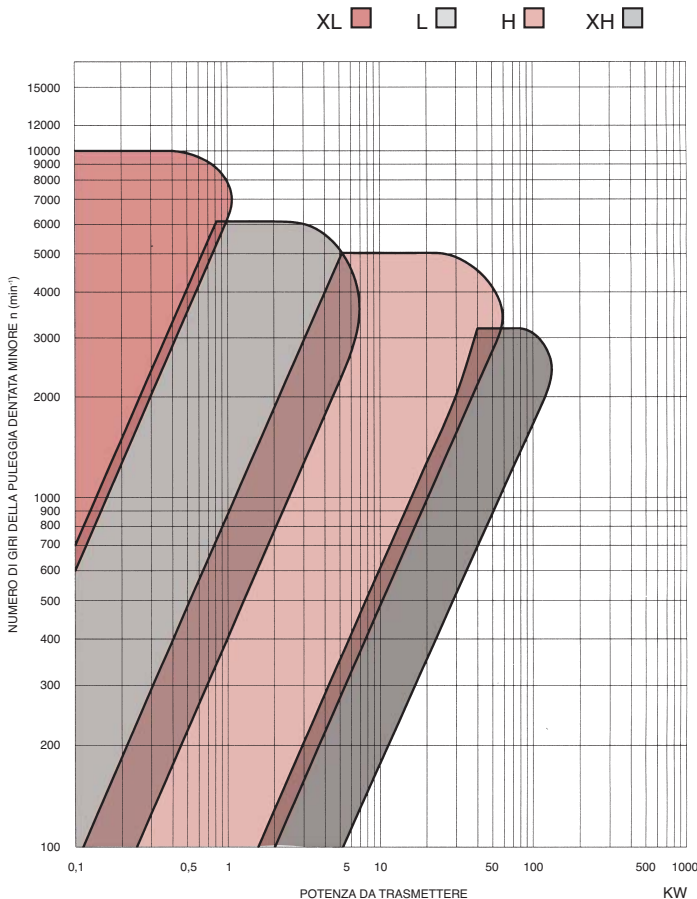

TOLLERANZE SULLE LUNGHEZZE

LENGTH TOLERANCES

lunghezza primitiva		tolleranza
in 1/10 di pollice	in mm	mm
< 36	< 91,4	± 0,15
> 36-100	> 91,4-254,0	± 0,20
> 100-150	> 254,0-381,0	± 0,23
> 150-200	> 381,0-508,0	± 0,25
> 200-300	> 508,0-762,0	± 0,30
> 300-390	> 762,0-990,6	± 0,33
> 390-480	> 990,6-1219,2	± 0,38
> 480-600	> 1219,2-1524,0	± 0,40
> 600-700	> 1524,0-1778,0	± 0,43
> 700-800	> 1778,0-2032,0	± 0,45
> 800-900	> 2032,0-2286,0	± 0,48
> 900-1000	> 2286,0-2540,0	± 0,50
> 1000-1100	> 2540,0-2794,0	± 0,53
> 1100-1200	> 2794,0-3048,0	± 0,55
> 1200-1260	> 3048,0-3200,4	± 0,58
> 1260-1400	> 3200,4-3556,0	± 0,60
> 1400-1600	> 3556,0-4064,0	± 0,65
> 1600-1700	> 4064,0-4318,0	± 0,68
> 1700-1800	> 4318,0-4572,0	± 0,70

CINGHIE DENTATE POSITIVE SYNCHROBELT® - ISO 5296

TIMING BELTS - ISO 5296



XL PASSO 1/5" (5,080 mm)

MATERIALE: NEOPRENE

codice	denti	sviluppo	
		pollici	mm
60 XL	30	6,00	152,40
70 XL	35	7,00	177,80
80 XL	40	8,00	203,20
90 XL	45	9,00	228,60
100 XL	50	10,00	254,00
102 XL	51	10,20	259,08
106 XL	53	10,60	269,24
108 XL	54	10,80	274,32
110 XL	55	11,00	279,40
116 XL	58	11,60	294,64
120 XL	60	12,00	304,80
130 XL	65	13,00	330,20
140 XL	70	14,00	355,60
148 XL	74	14,80	375,92
150 XL	75	15,00	381,00
160 XL	80	16,00	406,40
170 XL	85	17,00	431,80
180 XL	90	18,00	457,20
190 XL	95	19,00	482,60
200 XL	100	20,00	508,00
210 XL	105	21,00	533,40
220 XL	110	22,00	558,80
230 XL	115	23,00	584,20
240 XL	120	24,00	609,60
250 XL	125	25,00	635,00
260 XL	130	26,00	660,40
270 XL	135	27,00	685,80
280 XL	140	28,00	711,20
290 XL	145	29,00	736,60
300 XL	150	30,00	762,00
316 XL	158	31,60	802,64
330 XL	165	33,00	838,20
344 XL	172	34,40	873,76
380 XL	190	38,00	965,20

codice	larghezza cinghia	
	pollici	mm
XL 025	1/4"	6,35
XL 031	5/16"	7,94
XL 037	3/8"	9,52

L PASSO 3/8" (9,525 mm)

MATERIALE: NEOPRENE

codice	denti	sviluppo	
		pollici	mm
124 L	33	12,37	314,33
150 L	40	15,00	381,00
187 L	50	18,75	476,25
210 L	56	21,00	533,40
225 L	60	22,50	571,50
240 L	64	24,00	609,60
255 L	68	25,50	647,70
270 L	72	27,00	685,80
285 L	76	28,50	723,90
300 L	80	30,00	762,00
322 L	86	32,25	819,15
345 L	92	34,50	876,20
367 L	98	36,75	933,45
390 L	104	39,00	990,60
420 L	112	42,00	1066,80
450 L	120	45,00	1143,00
480 L	128	48,00	1219,20
510 L	136	51,00	1295,40
540 L	144	54,00	1371,60
600 L	160	60,00	1524,00

codice	larghezza cinghia	
	pollici	mm
L 050	1/2"	12,70
L 075	3/4"	19,05
L 100	1"	25,40

CINGHIE DENTATE POSITIVE SYNCHROBELT® - ISO 5296

TIMING BELTS - ISO 5296



H PASSO 1/2" (12,700 mm)

MATERIALE: NEOPRENE

codice	denti	sviluppo	
		pollici	mm
240 H	48	24,00	609,60
270 H	54	27,00	685,80
300 H	60	30,00	762,00
330 H	66	33,00	838,20
360 H	72	36,00	914,40
390 H	78	39,00	990,60
420 H	84	42,00	1066,80
450 H	90	45,00	1143,00
480 H	96	48,00	1219,20
510 H	102	51,00	1295,40
540 H	108	54,00	1371,60
570 H	114	57,00	1447,80
600 H	120	60,00	1524,00
630 H	126	63,00	1600,20
660 H	132	66,00	1676,40
700 H	140	70,00	1778,00
730 H	146	73,00	1854,20
750 H	150	75,00	1905,00
800 H	160	80,00	2032,00
850 H	170	85,00	2159,00
900 H	180	90,00	2286,00
1000 H	200	100,00	2540,00
1100 H	220	110,00	2794,00
1250 H	250	125,00	3175,00
1400 H	280	140,00	3556,00
1700 H	340	170,00	4318,00

XH PASSO 7/8" (22,225 mm)

MATERIALE: NEOPRENE

codice	denti	sviluppo	
		pollici	mm
507 XH	58	50,75	1289,05
560 XH	64	56,00	1422,40
630 XH	72	63,00	1600,20
700 XH	80	70,00	1778,00
770 XH	88	77,00	1955,80
840 XH	96	84,00	2133,60
980 XH	112	98,00	2489,20
1120 XH	128	112,00	2844,80
1260 XH	144	126,00	3200,40
1400 XH	160	140,00	3556,00
1540 XH	176	154,00	3911,60
1750 XH	200	175,00	4445,00

codice	larghezza cinghia	
	pollici	mm
H 075	3/4"	19,05
H 100	1"	25,40
H 150	1 1/2"	38,10
H 200	2"	50,80
H 300	3"	76,20

codice	larghezza cinghia	
	pollici	mm
XH 200	2"	50,80
XH 300	3"	76,20
XH 400	4"	101,60
XH 500	5"	127,00

CINGHIE DENTATE SYNCHROBELT® - "HTD" TIMING BELTS "HTD"

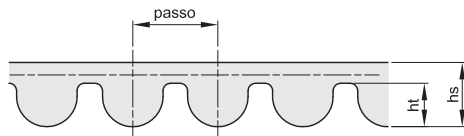

MATERIALE: NEOPRENE CON CAVI IN FIBRA DI VETRO

DIMENSIONAMENTO E TOLLERANZE SULLO SPESSORE SIZES AND TOLERANCES OF THE THICKNESS

tipo	passo mm	hs mm	toll. mm	ht mm
HTD 3M	3	2,4	±0,20	1,2
HTD 5M	5	3,6	±0,25	2,1
HTD 8M	8	5,6	±0,40	3,4
HTD 14M	14	10,0	±0,60	6,1

TOLLERANZE SULLE LARGHEZZE WIDTH TOLERANCES

larghezza cinghia	tolleranza di larghezza sulla lunghezza primitiva		
	fino a 880 mm	> 880 fino a 1760 mm	> 1760 mm
≤ 9	+0,4 -0,8	+0,4 -0,8	
> 9 - 40	+0,8 -0,8	+0,8 -1,2	+0,8 -1,2
> 40 - 50	+0,8 -1,2	+1,2 -1,2	+1,2 -1,5
> 50 - 85	+1,2 -1,2	+1,5 -1,5	+1,5 -2,0
> 85 - 170	+1,5 -1,5	+1,5 -2,0	+2,0 -2,0
> 170		+4,8 -4,8	+4,8 -4,8

SCELTA DEL PASSO DELLE CINGHIE DENTATE BELT PITCH SELECTION CHART

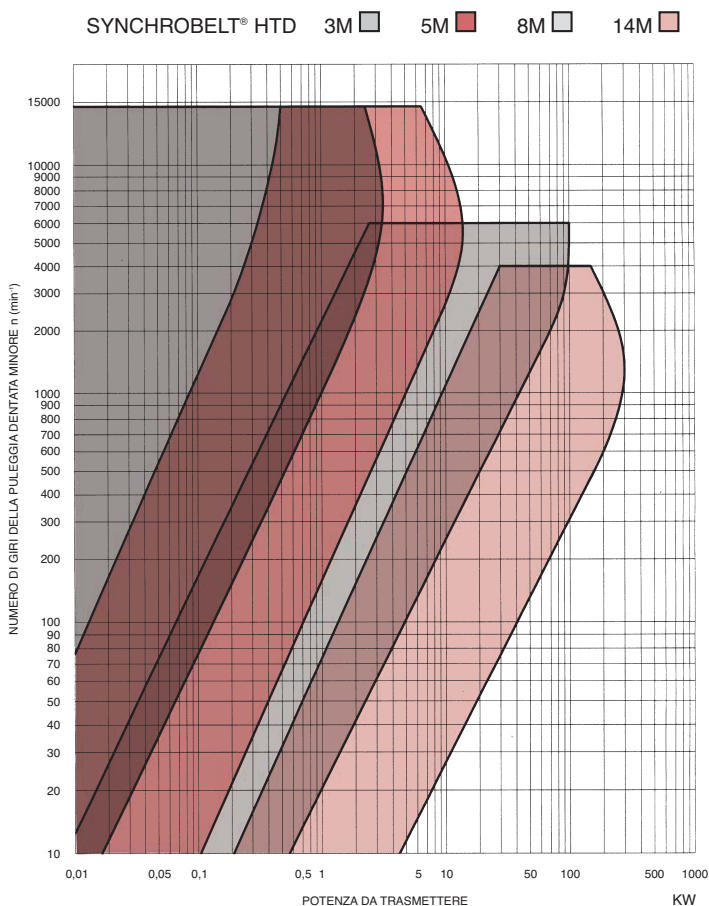

TOLLERANZE SULLE LUNGHEZZE LENGTH TOLERANCES

lunghezza primitiva mm	tolleranza mm
≤ 150	± 0,30
> 150 - 255	± 0,40
> 255 - 400	± 0,45
> 400 - 560	± 0,50
> 560 - 800	± 0,60
> 800 - 1000	± 0,65
> 1000 - 1270	± 0,75
> 1270 - 1500	± 0,80
> 1500 - 1800	± 0,85
> 1800 - 2000	± 0,90
> 2000 - 2250	± 0,95
> 2250	

Ogni 250 mm di aumento della lunghezza la tolleranza aumenta di volta in volta di 0,05 mm.

CINGHIE DENTATE SYNCHROBELT® - "HTD"

TIMING BELTS "HTD"



HTD 3M PASSO 3 mm

MATERIALE: NEOPRENE

codice	denti	sviluppo
111 3M	37	111
144 3M	48	144
159 3M	53	159
168 3M	56	168
174 3M	58	174
177 3M	59	177
210 3M	70	210
213 3M	71	213
216 3M	72	216
225 3M	75	225
252 3M	84	252
255 3M	85	255
267 3M	89	267
300 3M	100	300
318 3M	106	318
336 3M	112	336
339 3M	113	339
363 3M	121	363
384 3M	128	384
390 3M	130	390
420 3M	140	420
447 3M	149	447
474 3M	158	474
480 3M	160	480
501 3M	167	501
513 3M	171	513
537 3M	179	537
564 3M	188	564
606 3M	202	606
633 3M	211	633
711 3M	237	711
882 3M	294	882
945 3M	315	945
1041 3M	347	1041
1068 3M	356	1068
1071 3M	357	1071
1125 3M	375	1125
1569 3M	523	1569

HTD 5M PASSO 5 mm

MATERIALE: NEOPRENE

codice	denti	sviluppo
300 5M	60	300
330 5M	66	330
350 5M	70	350
375 5M	75	375
400 5M	80	400
425 5M	85	425
450 5M	90	450
475 5M	95	475
500 5M	100	500
535 5M	107	535
565 5M	113	565
600 5M	120	600
615 5M	123	615
620 5M	124	620
630 5M	126	630
635 5M	127	635
665 5M	133	665
710 5M	142	710
755 5M	151	755
800 5M	160	800
890 5M	178	890
900 5M	180	900
925 5M	185	925
1000 5M	200	1000
1050 5M	210	1050
1125 5M	225	1125
1270 5M	254	1270
1500 5M	300	1500

codice	larghezza cinghia mm
HTD 3	6
	9
	15

codice	larghezza cinghia mm
HTD 5	9
	15
	25

CINGHIE DENTATE SYNCHROBELT® - "HTD"

TIMING BELTS "HTD"



HTD 8M PASSO 8 mm

MATERIALE: NEOPRENE

codice	denti	sviluppo
376 8M	47	376
424 8M	53	424
480 8M	60	480
560 8M	70	560
600 8M	75	600
640 8M	80	640
656 8M	82	656
720 8M	90	720
784 8M	98	784
800 8M	100	800
880 8M	110	880
960 8M	120	960
1040 8M	130	1040
1120 8M	140	1120
1200 8M	150	1200
1280 8M	160	1280
1360 8M	170	1360
1440 8M	180	1440
1600 8M	200	1600
1760 8M	220	1760
1800 8M	225	1800
2000 8M	250	2000
2248 8M	281	2248
2400 8M	300	2400
2800 8M	350	2800

HTD 14M PASSO 14 mm

MATERIALE: NEOPRENE

codice	denti	sviluppo
966 14M	69	966
1190 14M	85	1190
1400 14M	100	1400
1610 14M	115	1610
1778 14M	127	1778
1890 14M	135	1890
2100 14M	150	2100
2310 14M	165	2310
2450 14M	175	2450
2590 14M	185	2590
2800 14M	200	2800
3150 14M	225	3150
3500 14M	250	3500
3850 14M	275	3850
4326 14M	309	4326
4578 14M	327	4578

codice	larghezza cinghia mm
HTD 8	20
	30
	50
	85

codice	larghezza cinghia mm
HTD 14	40
	55
	85
	115
	170

CINGHIE DENTATE PASSO METRICO SERIE "T" - DIN 7721-1

METRIC BELTS "T" - DIN 7721-1

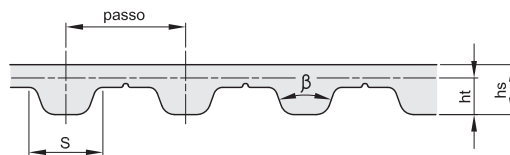

MATERIALE: POLIURETANO CON CAVI IN ACCIAIO.

DIMENSIONAMENTO E TOLLERANZE SULLO SPESSORE

SIZES AND TOLERANCES OF THE THICKNESS

tipo	passo mm	hs mm	toll. mm	ht mm	S mm	β gradi
T 2,5	2,5	1,3	±0,15	0,7	1,50	40
T 5	5	2,2	±0,15	1,2	2,65	40
T 10	10	4,5	±0,30	2,5	5,30	40

TOLLERANZE SULLE LARGHEZZE

WIDTH TOLERANCES

passo mm	larghezza mm	tolleranza mm
2,5	6	± 0,30
5	10	± 0,50
5	16	± 0,50
5	25	± 0,50
10	16	± 0,50
10	25	± 0,50
10	32	± 0,50
10	50	± 0,50

SCELTA DEL PASSO DELLE CINGHIE DENTATE

BELT PITCH SELECTION CHART

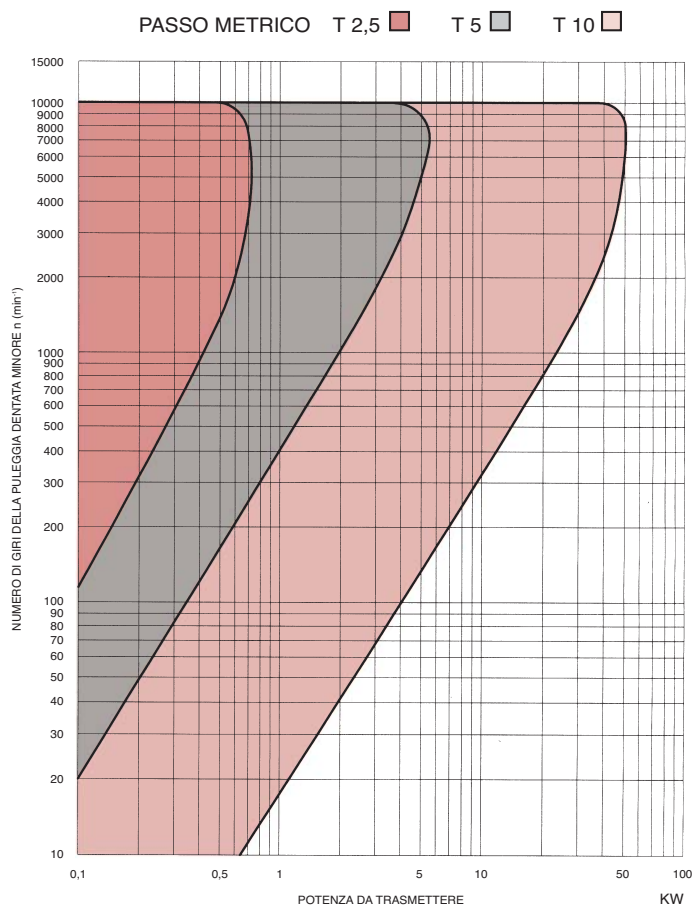

TOLLERANZE SULLE LUNGHEZZE

LENGTH TOLERANCES

lunghezza primitiva mm	tolleranza mm
≤ 305	± 0,28
> 305 - 390	± 0,32
> 390 - 525	± 0,36
> 525 - 630	± 0,42
> 630 - 780	± 0,48
> 780 - 990	± 0,51
> 990 - 1250	± 0,64
> 1250 - 1560	± 0,76
> 1560 - 1960	± 0,88
> 1960 - 2250	± 1,04

CINGHIE DENTATE PASSO METRICO SERIE "T" - DIN 7721-1
METRIC BELTS "T" - DIN 7721-1



T 2,5 PASSO 2,5 mm

MATERIALE: POLIURETANO

codice	denti	sviluppo	codice	denti	sviluppo
T 2,5 120	48	120,0			
T 2,5 145	58	145,0			
T 2,5 160	64	160,0			
T 2,5 177,5	71	177,5			
T 2,5 200	80	200,0			
T 2,5 230	92	230,0			
T 2,5 245	98	245,0			
T 2,5 265	106	265,0			
T 2,5 285	114	285,0			
T 2,5 305	122	305,0			
T 2,5 317,5	127	317,5			
T 2,5 330	132	330,0			
T 2,5 380	152	380,0			
T 2,5 420	168	420,0			
T 2,5 480	192	480,0			
T 2,5 500	200	500,0			
T 2,5 600	240	600,0			
T 2,5 650	260	650,0			
T 2,5 680	272	680,0			
T 2,5 780	312	780,0			
T 2,5 880	352	880,0			
T 2,5 915	366	915,0			
T 2,5 950	380	950,0			
T 2,5 1185	474	1185,0			

codice	larghezza cinghia mm
T 2,5	6

codice	larghezza cinghia mm

CINGHIE DENTATE PASSO METRICO SERIE "T" - DIN 7721-1

METRIC BELTS "T" - DIN 7721-1

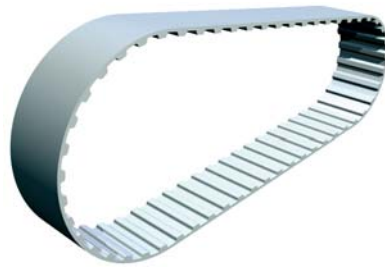

T 5 PASSO 5 mm

MATERIALE: POLIURETANO

codice	denti	sviluppo	codice	denti	sviluppo
T 5 185	37	185,0	T 5 750	150	750,0
T 5 200	40	200,0	T 5 780	156	780,0
T 5 215	43	215,0	T 5 815	163	815,0
T 5 220	44	220,0	T 5 830	166	830,0
T 5 225	45	225,0	T 5 840	168	840,0
T 5 245	49	245,0	T 5 900	180	900,0
T 5 255	51	255,0	T 5 990	198	990,0
T 5 260	52	260,0	T 5 1075	215	1075,0
T 5 270	54	270,0	T 5 1100	220	1100,0
T 5 280	56	280,0	T 5 1160	232	1160,0
T 5 295	59	295,0	T 5 1215	243	1215,0
T 5 305	61	305,0	T 5 1280	256	1280,0
T 5 330	66	330,0	T 5 1315	263	1315,0
T 5 340	68	340,0			
T 5 350	70	350,0			
T 5 355	71	355,0			
T 5 365	73	365,0			
T 5 390	78	390,0			
T 5 400	80	400,0			
T 5 410	82	410,0			
T 5 420	84	420,0			
T 5 455	91	455,0			
T 5 475	95	475,0			
T 5 480	96	480,0			
T 5 500	100	500,0			
T 5 510	102	510,0			
T 5 525	105	525,0			
T 5 545	109	545,0			
T 5 550	110	550,0			
T 5 560	112	560,0			
T 5 575	115	575,0			
T 5 610	122	610,0			
T 5 620	124	620,0			
T 5 630	126	630,0			
T 5 650	130	650,0			
T 5 660	132	660,0			
T 5 690	138	690,0			
T 5 720	144	720,0			

codice	larghezza cinghia mm
T 5	10
	16
	25

codice	larghezza cinghia mm

CINGHIE DENTATE PASSO METRICO SERIE "T" - DIN 7721-1

METRIC BELTS "T" - DIN 7721-1



T 10 PASSO 10 mm

MATERIALE: POLIURETANO

codice	denti	sviluppo	codice	denti	sviluppo
T 10 260	26	260,0	T 10 1350	135	1350,0
T 10 340	34	340,0	T 10 1390	139	1390,0
T 10 370	37	370,0	T 10 1400	140	1400,0
T 10 400	40	400,0	T 10 1420	142	1420,0
T 10 410	41	410,0	T 10 1460	146	1460,0
T 10 440	44	440,0	T 10 1500	150	1500,0
T 10 480	48	480,0	T 10 1560	156	1560,0
T 10 500	50	500,0	T 10 1610	161	1610,0
T 10 530	53	530,0	T 10 1750	175	1750,0
T 10 560	56	560,0	T 10 1780	178	1780,0
T 10 600	60	600,0	T 10 1880	188	1880,0
T 10 610	61	610,0	T 10 1960	196	1960,0
T 10 630	63	630,0	T 10 2250	225	2250,0
T 10 660	66	690,0			
T 10 690	69	690,0			
T 10 700	70	700,0			
T 10 720	72	720,0			
T 10 750	75	750,0			
T 10 780	78	780,0			
T 10 810	81	810,0			
T 10 840	84	840,0			
T 10 880	88	880,0			
T 10 890	89	890,0			
T 10 900	90	900,0			
T 10 920	92	920,0			
T 10 960	96	960,0			
T 10 970	97	970,0			
T 10 980	98	980,0			
T 10 1010	101	1010,0			
T 10 1080	108	1080,0			
T 10 1110	111	1110,0			
T 10 1140	114	1140,0			
T 10 1150	115	1150,0			
T 10 1210	121	1210,0			
T 10 1240	124	1240,0			
T 10 1250	125	1250,0			
T 10 1300	130	1300,0			
T 10 1320	132	1320,0			

codice	larghezza cinghia mm
T 10	16
	25
	32
	50

codice	larghezza cinghia mm

CINGHIE DENTATE PASSO METRICO SERIE "AT"

METRIC BELTS "AT"

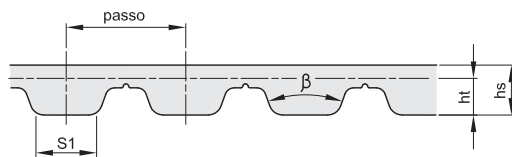

MATERIALE: POLIURETANO CON CAVI IN ACCIAIO.

DIMENSIONAMENTO E TOLLERANZE SULLO SPESSORE

SIZES AND TOLERANCES OF THE THICKNESS

tipo	passo mm	hs mm	toll. mm	ht mm	S1 mm	β gradi
AT 5	5	2,7	±0,15	1,2	2,5	50
AT 10	10	4,5	±0,30	2,5	5,0	50

TOLLERANZE SULLE LARGHEZZE

WIDTH TOLERANCES

passo mm	larghezza mm	tolleranza mm
5	10	± 0,50
5	16	± 0,50
5	25	± 0,50
10	16	± 0,50
10	25	± 0,50
10	32	± 0,50
10	50	± 0,50

SCELTA DEL PASSO DELLE CINGHIE DENTATE

BELT PITCH SELECTION CHART

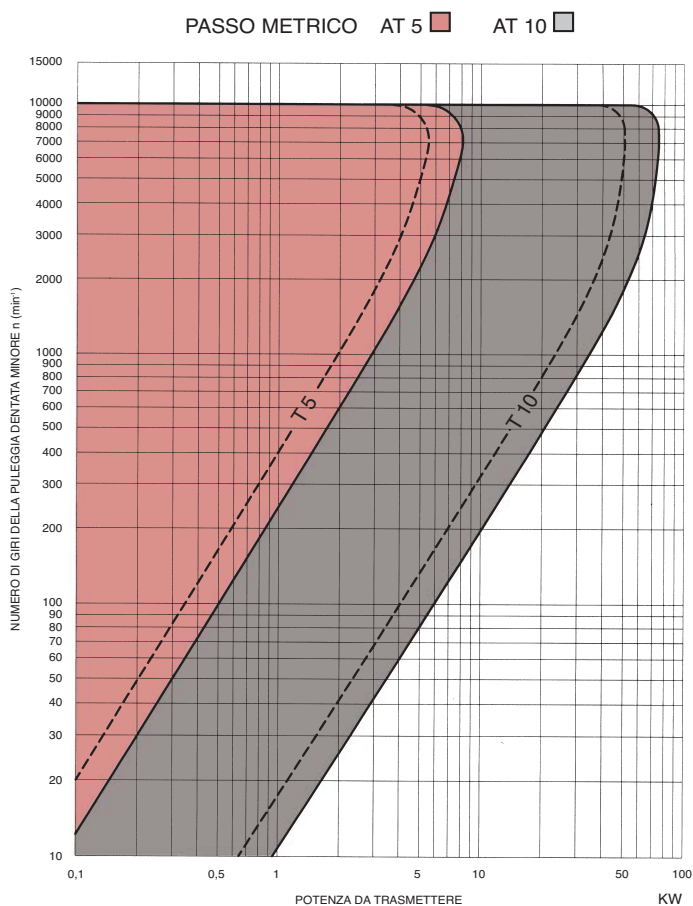

TOLLERANZE SULLE LUNGHEZZE

LENGTH TOLERANCES

lunghezza primitiva mm	tolleranza mm
≤ 305	± 0,28
> 305 - 390	± 0,32
> 390 - 525	± 0,36
> 525 - 630	± 0,42
> 630 - 780	± 0,48
> 780 - 990	± 0,51
> 990 - 1250	± 0,64
> 1250 - 1560	± 0,76
> 1560 - 1960	± 0,88
> 1960 - 2250	± 1,04

CINGHIE DENTATE PASSO METRICO SERIE "AT"

METRIC BELTS "AT"



AT 5 PASSO 5 mm

MATERIALE: POLIURETANO

codice	denti	sviluppo
AT 5 255	51	255,0
AT 5 300	60	300,0
AT 5 420	84	420,0
AT 5 455	91	455,0
AT 5 500	100	500,0
AT 5 545	109	545,0
AT 5 600	120	600,0
AT 5 660	132	660,0
AT 5 710	142	710,0
AT 5 750	150	750,0
AT 5 780	156	780,0
AT 5 825	165	825,0

AT 10 PASSO 10 mm

MATERIALE: POLIURETANO

codice	denti	sviluppo
AT 10 500	50	500,0
AT 10 560	56	560,0
AT 10 600	60	600,0
AT 10 610	61	610,0
AT 10 660	66	660,0
AT 10 700	70	700,0
AT 10 730	73	730,0
AT 10 780	78	780,0
AT 10 800	80	800,0
AT 10 840	84	840,0
AT 10 890	89	890,0
AT 10 920	92	920,0
AT 10 960	96	960,0
AT 10 980	98	980,0
AT 10 1000	100	1000,0
AT 10 1010	101	1010,0
AT 10 1050	105	1050,0
AT 10 1080	108	1080,0
AT 10 1100	110	1100,0
AT 10 1150	115	1150,0
AT 10 1210	121	1210,0
AT 10 1250	125	1250,0
AT 10 1350	135	1350,0
AT 10 1400	140	1400,0
AT 10 1420	142	1420,0
AT 10 1600	160	1600,0
AT 10 1800	180	1800,0

codice	larghezza cinghia mm
AT 5	10
	16
	25

codice	larghezza cinghia mm
AT 10	16
	25
	32
	50

MANICOTTI POSITIVI SYNCHROBELT® - ISO 5296

SLEEVES - ISO 5296



XL PASSO 1/5" (5,08 mm)

MATERIALE: NEOPRENE

codice	denti	sviluppo		larghezza mm
		pollici	mm	
60 XL	30	6,00	152,40	480
70 XL	35	7,00	177,80	480
80 XL	40	8,00	203,20	480
90 XL	45	9,00	228,60	480
100 XL	50	10,00	254,00	480
102 XL	51	10,20	259,08	480
106 XL	53	10,60	269,24	480
108 XL	54	10,80	274,32	480
110 XL	55	11,00	279,40	480
116 XL	58	11,60	294,64	480
120 XL	60	12,00	304,80	480
130 XL	65	13,00	330,20	480
140 XL	70	14,00	355,60	480
148 XL	74	14,80	375,92	480
150 XL	75	15,00	381,00	480
160 XL	80	16,00	406,40	480
170 XL	85	17,00	431,80	480
180 XL	90	18,00	457,20	480
190 XL	95	19,00	482,60	480
200 XL	100	20,00	508,00	480
210 XL	105	21,00	533,40	480
220 XL	110	22,00	558,80	480
230 XL	115	23,00	584,20	480
240 XL	120	24,00	609,60	480
250 XL	125	25,00	635,00	480
260 XL	130	26,00	660,40	480
270 XL	135	27,00	685,80	480
280 XL	140	28,00	711,20	480
290 XL	145	29,00	736,60	480
300 XL	150	30,00	762,00	480
316 XL	158	31,60	802,64	480
330 XL	165	33,00	838,20	480
344 XL	172	34,40	873,76	480
380 XL	190	38,00	965,20	480

L PASSO 3/8" (9,525 mm)

MATERIALE: NEOPRENE

codice	denti	sviluppo		larghezza mm
		pollici	mm	
124 L	33	12,37	314,33	480
150 L	40	15,00	381,00	480
187 L	50	18,75	476,25	480
210 L	56	21,00	533,40	480
225 L	60	22,50	571,50	480
240 L	64	24,00	609,60	480
255 L	68	25,50	647,70	480
270 L	72	27,00	685,80	480
285 L	76	28,50	723,90	480
300 L	80	30,00	762,00	480
322 L	86	32,25	819,15	480
345 L	92	34,50	876,20	480
367 L	98	36,75	933,45	480
390 L	104	39,00	990,60	480
420 L	112	42,00	1066,80	480
450 L	120	45,00	1143,00	480
480 L	128	48,00	1219,20	480
510 L	136	51,00	1295,40	480
540 L	144	54,00	1371,60	480
600 L	160	60,00	1524,00	480

MANICOTTI POSITIVI SYNCHROBELT® - ISO 5296

SLEEVES - ISO 5296



H PASSO 1/2" (12,700 mm)

MATERIALE: NEOPRENE

codice	denti	sviluppo		larghezza mm
		pollici	mm	
240 H	48	24,00	609,60	480
270 H	54	27,00	685,80	480
300 H	60	30,00	762,00	480
330 H	66	33,00	838,20	480
360 H	72	36,00	914,40	480
390 H	78	39,00	990,60	480
420 H	84	42,00	1066,80	480
450 H	90	45,00	1143,00	480
480 H	96	48,00	1219,20	480
510 H	102	51,00	1295,40	480
540 H	108	54,00	1371,60	480
570 H	114	57,00	1447,80	480
600 H	120	60,00	1524,00	480
630 H	126	63,00	1600,20	480
660 H	132	66,00	1676,40	480
700 H	140	70,00	1778,00	480
730 H	146	73,00	1854,20	480
750 H	150	75,00	1905,00	480
800 H	160	80,00	2032,00	480
850 H	170	85,00	2159,00	480
900 H	180	90,00	2286,00	480
1000 H	200	100,00	2540,00	480
1100 H	220	110,00	2794,00	480
1250 H	250	125,00	3175,00	480
1400 H	280	140,00	3556,00	480
1700 H	340	170,00	4318,00	480

XH PASSO 7/8" (22,225 mm)

MATERIALE: NEOPRENE

codice	denti	sviluppo		larghezza mm
		pollici	mm	
507 XH	58	50,75	1289,05	460
560 XH	64	56,00	1422,40	460
630 XH	72	63,00	1600,20	460
700 XH	80	70,00	1778,00	460
770 XH	88	77,00	1955,80	460
840 XH	96	84,00	2133,60	460
980 XH	112	98,00	2489,20	460
1120 XH	128	112,00	2844,80	460
1260 XH	144	126,00	3200,40	460
1400 XH	160	140,00	3556,00	460
1540 XH	176	154,00	3911,60	460
1750 XH	200	175,00	4445,00	460

MANICOTTI SYNCHROBELT® “HTD”

SLEEVES “HTD”



HTD 3M PASSO 3 mm

MATERIALE: NEOPRENE

codice	denti	sviluppo mm	larghezza mm
111 3M	37	111	480
144 3M	48	144	480
159 3M	53	159	480
168 3M	56	168	480
174 3M	58	174	480
177 3M	59	177	480
210 3M	70	210	480
213 3M	71	213	480
216 3M	72	216	480
225 3M	75	225	480
252 3M	84	252	480
255 3M	85	255	480
267 3M	89	267	480
300 3M	100	300	480
318 3M	106	318	480
336 3M	112	336	480
339 3M	113	339	480
363 3M	121	363	480
384 3M	128	384	480
390 3M	130	390	480
420 3M	140	420	480
447 3M	149	447	480
474 3M	158	474	480
480 3M	160	480	480
501 3M	167	501	480
513 3M	171	513	480
537 3M	179	537	480
564 3M	188	564	480
606 3M	202	606	480
633 3M	211	633	480
711 3M	237	711	480
882 3M	294	882	480
945 3M	315	945	480
1041 3M	347	1041	480
1068 3M	356	1068	480
1071 3M	357	1071	480
1125 3M	375	1125	480
1569 3M	523	1569	480

HTD 5M PASSO 5 mm

MATERIALE: NEOPRENE

codice	denti	sviluppo mm	larghezza mm
300 5M	60	300	480
330 5M	66	330	480
350 5M	70	350	480
375 5M	75	375	480
400 5M	80	400	480
425 5M	85	425	480
450 5M	90	450	480
475 5M	95	475	480
500 5M	100	500	480
535 5M	107	535	480
565 5M	113	565	480
600 5M	120	600	480
615 5M	123	615	480
620 5M	124	620	480
630 5M	126	630	480
635 5M	127	635	480
665 5M	133	665	480
710 5M	142	710	480
755 5M	151	755	480
800 5M	160	800	480
890 5M	178	890	480
900 5M	180	900	480
925 5M	185	925	480
1000 5M	200	1000	480
1050 5M	210	1050	480
1125 5M	225	1125	480
1270 5M	254	1270	480
1500 5M	300	1500	480

MANICOTTI SYNCHROBELT® "HTD"

SLEEVES "HTD"



HTD 8M PASSO 8 mm

MATERIALE: NEOPRENE

codice	denti	sviluppo mm	larghezza mm
376 8M	47	376	480
424 8M	53	424	480
480 8M	60	480	480
560 8M	70	560	480
600 8M	75	600	480
640 8M	80	640	480
656 8M	82	656	480
720 8M	90	720	480
784 8M	98	784	480
800 8M	100	800	480
880 8M	110	880	480
960 8M	120	960	480
1040 8M	130	1040	480
1120 8M	140	1120	480
1200 8M	150	1200	480
1280 8M	160	1280	480
1360 8M	170	1360	480
1440 8M	180	1440	480
1600 8M	200	1600	480
1760 8M	220	1760	480
1800 8M	225	1800	480
2000 8M	250	2000	480
2248 8M	281	2248	480
2400 8M	300	2400	480
2800 8M	350	2800	480

HTD 14M PASSO 14 mm

MATERIALE: NEOPRENE

codice	denti	sviluppo mm	larghezza mm
966 14M	69	966	470
1190 14M	85	1190	470
1400 14M	100	1400	470
1610 14M	115	1610	470
1778 14M	127	1778	470
1890 14M	135	1890	470
2100 14M	150	2100	470
2310 14M	165	2310	470
2450 14M	175	2450	470
2590 14M	185	2590	470
2800 14M	200	2800	470
3150 14M	225	3150	470
3500 14M	250	3500	470
3850 14M	275	3850	470
4326 14M	309	4326	470
4578 14M	327	4578	470

MANICOTTI DENTATI PASSO METRICO SERIE "T" - DIN 7721-1

SLEEVES "T" - DIN 7721-1

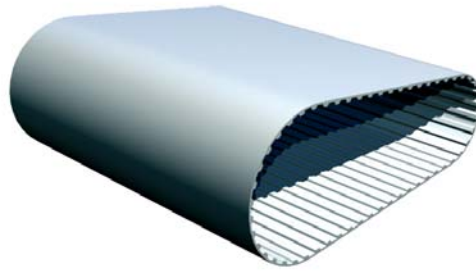

T2,5 PASSO 2,5 mm

MATERIALE: POLIURETANO

codice	dent	sviluppo mm	larghezza mm
T 2,5 120	48	120,0	200
T 2,5 145	58	145,0	200
T 2,5 160	64	160,0	200
T 2,5 177,5	71	177,5	200
T 2,5 200	80	200,0	200
T 2,5 230	92	230,0	200
T 2,5 245	98	245,0	200
T 2,5 265	106	265,0	200
T 2,5 285	114	285,0	200
T 2,5 305	122	305,0	200
T 2,5 317,5	127	317,5	200
T 2,5 330	132	330,0	200
T 2,5 380	152	380,0	200
T 2,5 420	168	420,0	200
T 2,5 480	192	480,0	200
T 2,5 500	200	500,0	200
T 2,5 600	240	600,0	200
T 2,5 650	260	650,0	200
T 2,5 780	312	780,0	200
T 2,5 915	366	915,0	200
T 2,5 950	380	950,0	200

MANICOTTI DENTATI PASSO METRICO SERIE "T" - DIN 7721-1

SLEEVES "T" - DIN 7721-1

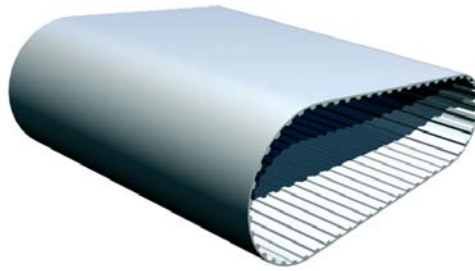

T 5 PASSO 5 mm

MATERIALE: POLIURETANO

codice	denti	sviluppo mm	larghezza mm
T 5 185	37	185,0	200
T 5 200	40	200,0	200
T 5 215	43	215,0	200
T 5 220	44	220,0	200
T 5 225	45	225,0	200
T 5 245	49	245,0	200
T 5 255	51	255,0	200
T 5 260	52	260,0	200
T 5 270	54	270,0	200
T 5 280	56	280,0	200
T 5 295	59	295,0	200
T 5 305	61	305,0	200
T 5 330	66	330,0	200
T 5 340	68	340,0	200
T 5 350	70	350,0	200
T 5 355	71	355,0	200
T 5 365	73	365,0	200
T 5 390	78	390,0	200
T 5 400	80	400,0	200
T 5 410	82	410,0	200
T 5 420	84	420,0	200
T 5 455	91	455,0	200
T 5 475	95	475,0	200
T 5 480	96	480,0	200
T 5 500	100	500,0	200
T 5 510	102	510,0	200
T 5 525	105	525,0	200
T 5 545	109	545,0	200
T 5 550	110	550,0	200
T 5 560	112	560,0	200
T 5 575	115	575,0	200
T 5 610	122	610,0	200
T 5 620	124	620,0	200
T 5 630	126	630,0	200
T 5 650	130	650,0	200
T 5 660	132	660,0	200
T 5 690	138	690,0	200
T 5 720	144	720,0	200

T 5 PASSO 5 mm

MATERIALE: POLIURETANO

codice	denti	sviluppo mm	larghezza mm
T 5 750	150	750,0	200
T 5 780	156	780,0	200
T 5 815	163	815,0	200
T 5 840	168	840,0	200
T 5 900	180	900,0	200
T 5 990	198	990,0	200
T 5 1075	215	1075,0	200
T 5 1100	220	1100,0	200
T 5 1215	243	1215,0	200
T 5 1315	263	1315,0	200

MANICOTTI DENTATI PASSO METRICO SERIE "T" - DIN 7721-1

SLEEVES "T" - DIN 7721-1

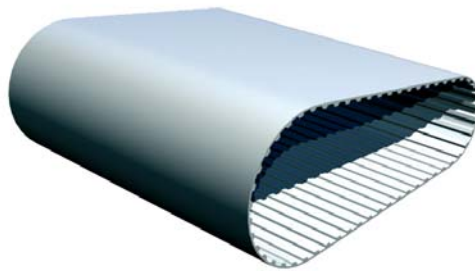

T 10 PASSO 10 mm

MATERIALE: POLIURETANO

codice	denti	sviluppo mm	larghezza mm
T 10 260	26	260,0	200
T 10 370	37	370,0	200
T 10 400	40	400,0	200
T 10 410	41	410,0	200
T 10 440	44	440,0	200
T 10 500	50	500,0	200
T 10 530	53	530,0	200
T 10 560	56	560,0	200
T 10 600	60	600,0	200
T 10 610	61	610,0	200
T 10 630	63	630,0	200
T 10 660	66	690,0	200
T 10 690	69	690,0	200
T 10 700	70	700,0	200
T 10 720	72	720,0	200
T 10 750	75	750,0	200
T 10 780	78	780,0	200
T 10 810	81	810,0	200
T 10 840	84	840,0	200
T 10 880	88	880,0	200
T 10 890	89	890,0	200
T 10 900	90	900,0	200
T 10 920	92	920,0	200
T 10 960	96	960,0	200
T 10 970	97	970,0	200
T 10 980	98	980,0	200
T 10 1010	101	1010,0	200
T 10 1080	108	1080,0	200
T 10 1110	111	1110,0	200
T 10 1140	114	1140,0	200
T 10 1150	115	1150,0	200
T 10 1210	121	1210,0	200
T 10 1240	124	1240,0	200
T 10 1250	125	1250,0	200
T 10 1300	130	1300,0	200
T 10 1320	132	1320,0	200

T 10 PASSO 10 mm

MATERIALE: POLIURETANO

codice	denti	sviluppo mm	larghezza mm
T 10 1350	135	1350,0	200
T 10 1390	139	1390,0	200
T 10 1400	140	1400,0	200
T 10 1420	142	1420,0	200
T 10 1460	146	1460,0	200
T 10 1500	150	1500,0	200
T 10 1560	156	1560,0	200
T 10 1610	161	1610,0	200
T 10 1750	175	1750,0	200
T 10 1780	178	1780,0	200
T 10 1880	188	1880,0	200
T 10 1960	196	1960,0	200
T 10 2250	225	2250,0	200

MANICOTTI DENTATI PASSO METRICO SERIE "AT" SLEEVES "AT"

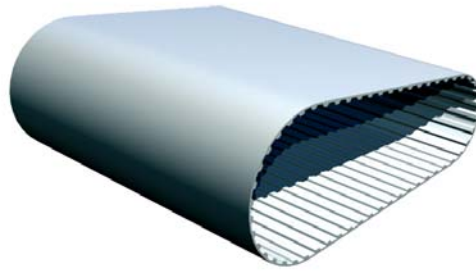

AT 5 PASSO 5 mm MATERIALE: POLIURETANO

codice	denti	sviluppo mm	larghezza mm
AT 5 255	51	255,0	200
AT 5 300	60	300,0	200
AT 5 420	84	420,0	200
AT 5 455	91	455,0	200
AT 5 500	100	500,0	200
AT 5 545	109	545,0	200
AT 5 600	120	600,0	200
AT 5 660	132	660,0	200
AT 5 750	150	750,0	200
AT 5 780	156	780,0	200
AT 5 825	165	825,0	200

AT 10 PASSO 10 mm MATERIALE: POLIURETANO

codice	denti	sviluppo mm	larghezza mm
AT 10 500	50	500,0	200
AT 10 560	56	560,0	200
AT 10 610	61	610,0	200
AT 10 660	66	660,0	200
AT 10 700	70	700,0	200
AT 10 730	73	730,0	200
AT 10 780	78	780,0	200
AT 10 800	80	800,0	200
AT 10 840	84	840,0	200
AT 10 890	89	890,0	200
AT 10 920	92	920,0	200
AT 10 960	96	960,0	200
AT 10 980	98	980,0	200
AT 10 1010	101	1010,0	200
AT 10 1050	105	1050,0	200
AT 10 1080	108	1080,0	200
AT 10 1150	115	1150,0	200
AT 10 1210	121	1210,0	200
AT 10 1250	125	1250,0	200
AT 10 1400	140	1400,0	200
AT 10 1600	160	1600,0	200
AT 10 1800	180	1800,0	200

CINGHIE DENTATE A METRAGGIO

LONG - LENGTH BELTING

MATERIALE: POLIURETANO CON CAVI IN ACCIAIO

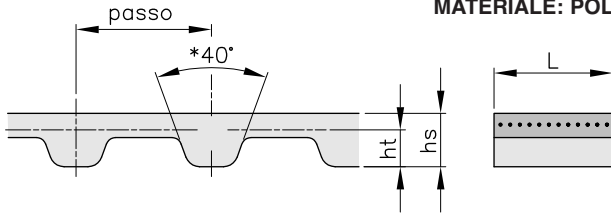

codice XL037 = *50°

XL - L - H

codice	passo mm	L mm	hs mm	ht mm	carico a trazione max N
XL 037	5,08	9,5 ± 0,5	2,3 ± 0,30	1,27	290
L 050	9,525	12,7 ± 0,5	3,6 ± 0,30	1,91	1270
L 075	9,525	19,1 ± 0,5	3,6 ± 0,30	1,91	1960
L 100	9,525	25,4 ± 0,5	3,6 ± 0,30	1,91	2760
L 150	9,525	38,1 ± 0,5	3,6 ± 0,30	1,91	4140
H 075	12,7	19,1 ± 0,5	4,3 ± 0,30	2,29	1960
H 100	12,7	25,4 ± 0,5	4,3 ± 0,30	2,29	2760
H 150	12,7	38,1 ± 0,5	4,3 ± 0,30	2,29	4140
H 200	12,7	50,8 ± 0,5	4,3 ± 0,30	2,29	5640

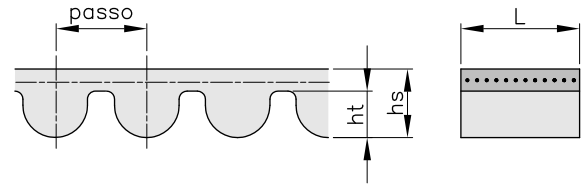

5M - 8M - 14M

codice	passo mm	L mm	hs mm	ht mm	carico a trazione max N
5M 9	5	9 ± 0,5	3,6 ± 0,20	2,1	920
5M 15	5	15 ± 0,5	3,6 ± 0,20	2,1	1500
5M 25	5	25 ± 0,5	3,6 ± 0,20	2,1	2650
8M 20	8	20 ± 0,5	5,6 ± 0,30	3,4	3190
8M 30	8	30 ± 0,5	5,6 ± 0,30	3,4	4900
8M 50	8	50 ± 0,5	5,6 ± 0,30	3,4	8580
8M 85	8	85 ± 0,5	5,6 ± 0,30	3,4	14700
14M 40	14	40 ± 1,0	10 ± 0,45	6,0	9120
14M 55	14	55 ± 1,0	10 ± 0,45	6,0	12480
14M 85	14	85 ± 1,0	10 ± 0,45	6,0	19680
14M 115	14	115 ± 1,0	10 ± 0,45	6,0	26880

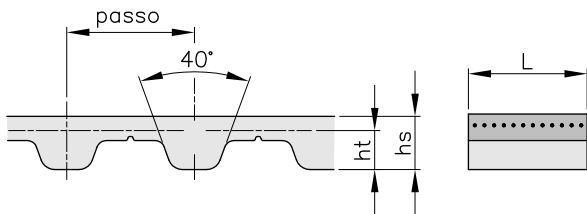

T5 - T10 - T20

codice	passo mm	L mm	hs mm	ht mm	carico a trazione max N
T5 6	5	6 ± 0,5	2,2 ± 0,15	1,2	190
T5 10	5	10 ± 0,5	2,2 ± 0,15	1,2	320
T5 16	5	16 ± 0,5	2,2 ± 0,15	1,2	540
T5 25	5	25 ± 0,5	2,2 ± 0,15	1,2	900
T5 32	5	32 ± 0,5	2,2 ± 0,15	1,2	1150
T5 50	5	50 ± 0,5	2,2 ± 0,15	1,2	1860
T10 16	10	16 ± 0,5	4,5 ± 0,30	2,5	1610
T10 25	10	25 ± 0,5	4,5 ± 0,30	2,5	2650
T10 32	10	32 ± 0,5	4,5 ± 0,30	2,5	3450
T10 50	10	50 ± 0,5	4,5 ± 0,30	2,5	5520
T10 75	10	75 ± 0,5	4,5 ± 0,30	2,5	8400
T10 100	10	100 ± 0,5	4,5 ± 0,30	2,5	11270
T20 25	20	25 ± 1,0	8,0 ± 0,45	5,0	4170
T20 32	20	32 ± 1,0	8,0 ± 0,45	5,0	5390
T20 50	20	50 ± 1,0	8,0 ± 0,45	5,0	8580
T20 75	20	75 ± 1,0	8,0 ± 0,45	5,0	12990
T20 100	20	100 ± 1,0	8,0 ± 0,45	5,0	17400

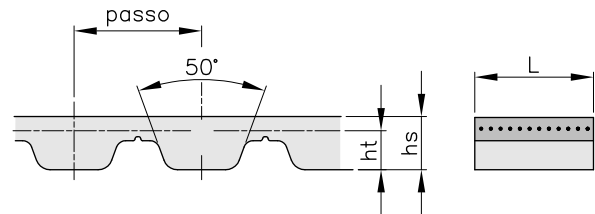

AT5 - AT10 - AT20

codice	passo mm	L mm	hs mm	ht mm	carico a trazione max N
AT 5 10	5	10 ± 0,5	2,7 ± 0,20	1,2	640
AT 5 16	5	16 ± 0,5	2,7 ± 0,20	1,2	1120
AT 5 25	5	25 ± 0,5	2,7 ± 0,20	1,2	1840
AT 5 32	5	32 ± 0,5	2,7 ± 0,20	1,2	2400
AT 10 16	10	16 ± 0,5	4,5 ± 0,30	2,5	2450
AT 10 25	10	25 ± 0,5	4,5 ± 0,30	2,5	4170
AT 10 32	10	32 ± 0,5	4,5 ± 0,30	2,5	5390
AT 10 50	10	50 ± 0,5	4,5 ± 0,30	2,5	8580
AT 20 25	20	25 ± 1,0	8,0 ± 0,45	5,0	5280
AT 20 32	20	32 ± 1,0	8,0 ± 0,45	5,0	7200
AT 20 50	20	50 ± 1,0	8,0 ± 0,45	5,0	11520
AT 20 75	20	75 ± 1,0	8,0 ± 0,45	5,0	17280
AT 20 100	20	100 ± 1,0	8,0 ± 0,45	5,0	23520

PIASTRE DI BLOCCAGGIO PER CINGHIE DENTATE

CLAMPING BELT PLATES

Le piastre di bloccaggio per cinghie sono utilizzate per fissare le estremità della cinghia qualora si voglia ottenere, dal moto rotatorio delle pulegge, un moto rettilineo alternato per tavole o altri dispositivi.

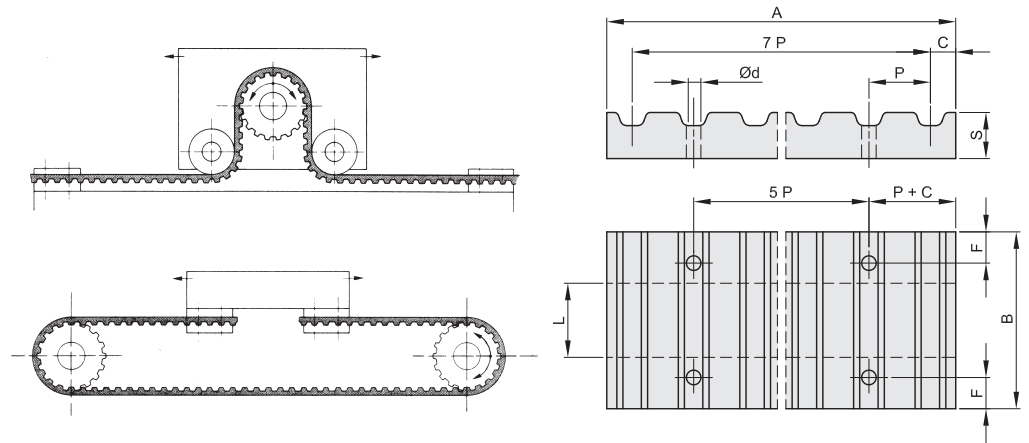

Materiale Alluminio

codice	passo	A	B	Ø d	F	C	S	L	Kg.
XL 025	5,08	42,5	25,5	5,5	6	3,5	8	6,4	0,02
XL 037	5,08	42,5	28,5	5,5	6	3,5	8	9,5	0,02
L 050	9,525	76,6	39	9	8	5	15	12,7	0,10
L 075	9,525	76,6	45	9	8	5	15	19,1	0,12
L 100	9,525	76,6	51,5	9	8	5	15	25,4	0,14
H 050	12,70	106,9	45	11	10	9	22	12,7	0,25
H 075	12,70	106,9	51	11	10	9	22	19,1	0,28
H 100	12,70	106,9	57,5	11	10	9	22	25,4	0,32
5M 9	5	41,5	28	5,5	6	3,2	8	9	0,02
5M 15	5	41,5	34	5,5	6	3,2	8	15	0,03
5M 25	5	41,5	44	5,5	6	3,2	8	25	0,04
8M 20	8	66	45	9	8	5	15	20	0,10
8M 30	8	66	55	9	8	5	15	30	0,12
8M 50	8	66	75	9	8	5	15	50	0,17
8M 85	8	66	110	9	8	5	15	85	0,25
14M 40	14	116	71	11	10	9	22	40	0,40
14M 55	14	116	86	11	10	9	22	55	0,50
14M 85	14	116	116	11	10	9	22	85	0,68
14M 115	14	116	146	11	10	9	22	115	0,85
14M 170	14	116	201	11	10	9	22	170	1,20
T 5 10	5	41,8	29	5,5	6	3,4	8	10	0,02
T 5 16	5	41,8	35	5,5	6	3,4	8	16	0,03
T 5 25	5	41,8	44	5,5	6	3,4	8	25	0,04
T10 16	10	80	41	9	8	5	15	16	0,11
T10 25	10	80	50	9	8	5	15	25	0,14
T10 32	10	80	57	9	8	5	15	32	0,16
T10 50	10	80	75	9	8	5	15	50	0,22
AT5 10	5	41,8	29	5,5	6	3,4	8	10	0,02
AT5 16	5	41,8	35	5,5	6	3,4	8	16	0,03
AT5 25	5	41,8	44	5,5	6	3,4	8	25	0,04
AT10 16	10	80	41	9	8	5	15	16	0,11
AT10 25	10	80	50	9	8	5	15	25	0,14
AT10 32	10	80	57	9	8	5	15	32	0,16
AT10 50	10	80	75	9	8	5	15	50	0,22

PULEGGE A GOLE TRAPEZOIDALI PER BUSSOLA CONICA V-BELTS PULLEYS FOR TAPER BUSHES

Descrizione e caratteristiche - Description and features

Le pulegge per cinghie trapezoidali sono costruite secondo le specifiche ISO 4183 / DIN 2211

Our V-belt pulleys are manufactured according to International Standard ISO 4183 / DIN 2211

Materiale - Material

Ghisa EN-GJL-200 (G20 - UNI 5007)

Cast iron EN-GJL-200(G20 - UNI 5007)

Trattamento e Bilanciatura

Protective treatment and Balancing

Tutte le pulegge standard sono protette con un trattamento superficiale di FOSFATAZIONE e BILANCIATE STATICAMENTE per essere idonee ad un funzionamento fino alla velocità periferica di 35 m/sec.

The surface of all our standard pulleys is protected by phosphated treatment. All the pulleys are Statically Balanced and can be used for peripheric speed up to 35 m/sec



Calcolo della velocità periferica (Vp) Periferic speed table (Vp)

$$V_p = \frac{\pi \cdot d_p \cdot n}{60 \cdot 1000} = \frac{d_p \cdot n}{19100} = \text{m/sec}$$

d_p = diametro in mm - diameter/mm

n = giri al minuto - revolutions per minute

V_p = velocità in m/sec - speed

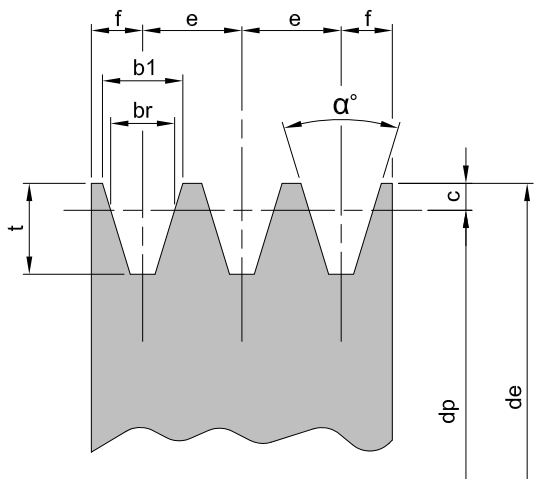

Dimensioni puleggia Dimension of Pulleys

codice	dp mm	α gradi	b1 mm	br mm	e mm	f mm	c mm	t mm
SPZ (mm)	< 80	34°	9,7	8,5	12	8	2	11
	> 80	38°						
SPA (mm)	< 118	34°	12,7	11	15	10	2,8	13,8
	> 118	38°						
SPB (mm)	< 190	34°	16,3	14	19	12,5	3,5	17,5
	> 190	38°						
SPC (mm)	< 315	34°	22,0	19	25,5	17	4,8	23,8
	> 315	38°						

PULEGGE A GOLE TRAPEZOIDALI PER BUSSOLA CONICA V-BELTS PULLEYS FOR TAPER BUSHES

SPZ - 1

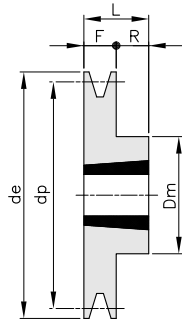

1

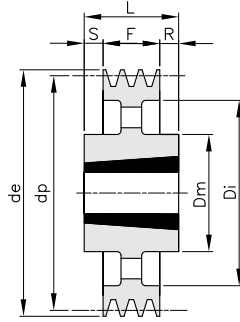

4

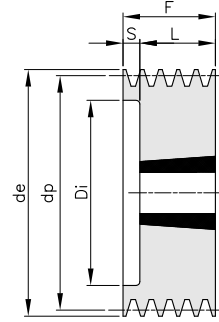

8

Materiale GHISA EN-GJL-200 / *Materiale Acciaio

codice	gole	dp	de	tipo	bussola	foro MAX	Dm	Di	E	F	L	R	S	Kg.
*SPZ 50 01	1	50	54	8	1008	25		26		37	25		12	0,40
*SPZ 56 01	1	56	60	8	1008	25		32		37	25		12	0,50
*SPZ 60 01	1	60	64	1	1008	25				22	22			0,50
SPZ 63 01	1	63	67	1	1108	28	56			16	22	6		0,40
SPZ 67 01	1	67	71	1	1108	28	60			16	22	6		0,50
SPZ 71 01	1	71	75	1	1108	28	60			16	22	6		0,50
SPZ 75 01	1	75	79	1	1108	28	60			16	22	6		0,60
SPZ 80 01	1	80	84	1	1210	32	75			16	25	9		0,60
SPZ 85 01	1	85	89	1	1210	32	80			16	25	9		0,80
SPZ 90 01	1	90	94	1	1210	32	80			16	25	9		0,80
SPZ 95 01	1	95	99	1	1210	32	85			16	25	9		0,90
SPZ 100 01	1	100	104	1	1210	32	85			16	25	9		0,90
SPZ 106 01	1	106	110	1	1610	42	92			16	25	9		1,00
SPZ 112 01	1	112	116	1	1610	42	92			16	25	9		1,10
SPZ 118 01	1	118	122	1	1610	42	92			16	25	9		1,30
SPZ 125 01	1	125	129	1	1610	42	92			16	25	9		1,40
SPZ 132 01	1	132	136	1	1610	42	92			16	25	9		1,50
SPZ 140 01	1	140	144	1	1610	42	92			16	25	9		1,50
SPZ 150 01	1	150	154	1	1610	42	92			16	25	9		1,60
SPZ 160 01	1	160	164	1	1610	42	92			16	25	9		1,70
SPZ 170 01	1	170	174	1	1610	42	92			16	25	9		1,80
SPZ 180 01	1	180	184	4	1610	42	92	152		16	25	9		2,00
SPZ 190 01	1	190	194	4	1610	42	92	162		16	25	9		2,20
SPZ 200 01	1	200	204	4	2012	50	112	171		16	32	16		2,60
SPZ 224 01	1	224	228	4	2012	50	112	195		16	32	16		2,80
SPZ 250 01	1	250	254	4	2012	50	112	221		16	32	8	8	3,20
SPZ 280 01	1	280	284	4	2012	50	112	251		16	32	8	8	3,50
SPZ 315 01	1	315	319	4	2012	50	112	286		16	32	8	8	3,80
SPZ 355 01	1	355	359	4	2012	50	112	326		16	32	8	8	4,20
SPZ 400 01	1	400	404	4	2012	50	112	371		16	32	8	8	6,00
SPZ 450 01	1	450	454	4	2517	65	124	421		16	45	14,5	14,5	11,00

PULEGGE A GOLE TRAPEZOIDALI PER BUSSOLA CONICA V-BELTS PULLEYS FOR TAPER BUSHES

SPZ - 2

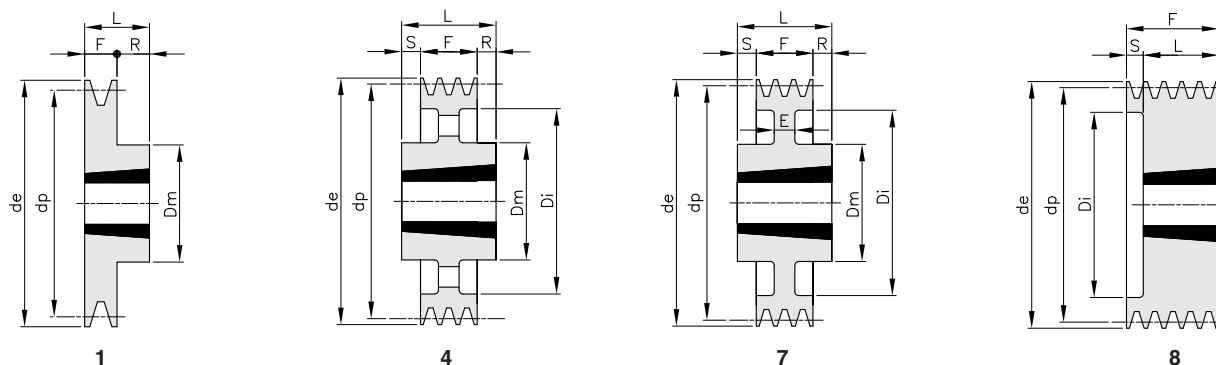

Materiale GHISA EN-GJL-200 / *Materiale Acciaio

codice	gole	dp	de	tipo	bussola	foro MAX	Dm	Di	E	F	L	R	S	Kg.
*SPZ 50 02	2	50	54	8	1008	25		26		50	25		25	0,30
*SPZ 56 02	2	56	60	8	1008	25		32		49	22		27	0,60
SPZ 60 02	2	60	64	8	1108	28		36		49	22		27	0,60
SPZ 63 02	2	63	67	8	1108	28		40		28	22		6	0,50
SPZ 67 02	2	67	71	8	1108	28		42		28	22		6	0,50
SPZ 71 02	2	71	75	8	1108	28		42		28	22		6	0,50
SPZ 75 02	2	75	79	8	1210	32		51		28	25		3	0,60
SPZ 80 02	2	80	84	8	1210	32		51		28	25		3	0,70
SPZ 85 02	2	85	89	8	1610	42		60		28	25		3	0,70
SPZ 90 02	2	90	94	8	1610	42		61		28	25		3	0,80
SPZ 95 02	2	95	99	8	1610	42		66		28	25		3	0,80
SPZ 100 02	2	100	104	8	1610	42		71		28	25		3	1,20
SPZ 106 02	2	106	110	8	1610	42		76		28	25		3	1,20
SPZ 112 02	2	112	116	8	1610	42		83		28	25		3	1,30
SPZ 118 02	2	118	122	8	1610	42		90		28	25		3	1,40
SPZ 125 02	2	125	129	8	1610	42		96		28	25		3	1,70
SPZ 132 02	2	132	136	8	1610	42		103		28	25		3	2,00
SPZ 140 02	2	140	144	8	1610	42		111		28	25		3	2,20
SPZ 150 02	2	150	154	1	2012	50	112			28	32	4		2,30
SPZ 160 02	2	160	164	1	2012	50	112			28	32	4		2,50
SPZ 170 02	2	170	174	1	2012	50	112			28	32	4		2,60
SPZ 180 02	2	180	184	7	2012	50	112	152	10	28	32	4		2,90
SPZ 190 02	2	190	194	7	2012	50	112	162	10	28	32	4		3,30
SPZ 200 02	2	200	204	4	2012	50	112	171		28	32	4		3,50
SPZ 224 02	2	224	228	4	2012	50	112	195		28	32	4		3,70
SPZ 250 02	2	250	254	4	2012	50	112	221		28	32	2	2	3,90
SPZ 280 02	2	280	284	4	2012	50	112	251		28	32	2	2	4,90
SPZ 315 02	2	315	319	4	2012	50	112	286		28	32	2	2	5,80
SPZ 355 02	2	355	359	4	2012	50	112	326		28	32	2	2	6,30
SPZ 400 02	2	400	404	4	2517	65	124	371		28	45	8,5	8,5	7,10
SPZ 450 02	2	450	454	4	2517	65	124	421		28	45	8,5	8,5	9,40
SPZ 500 02	2	500	504	4	2517	65	124	471		28	45	8,5	8,5	10,50

PULEGGE A GOLE TRAPEZOIDALI PER BUSSOLA CONICA V-BELTS PULLEYS FOR TAPER BUSHES

SPZ - 3

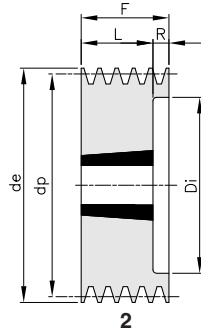

2

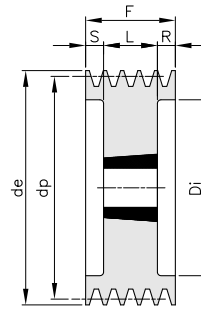

3

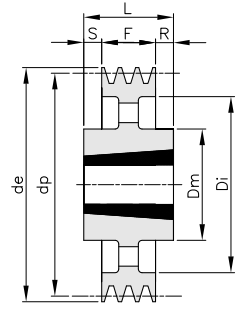

4

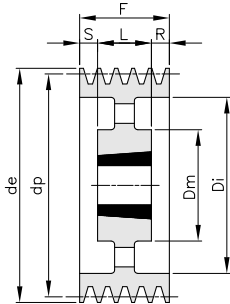

5

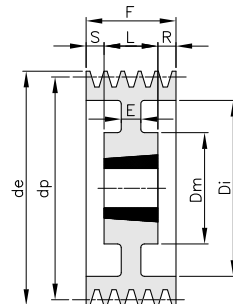

6

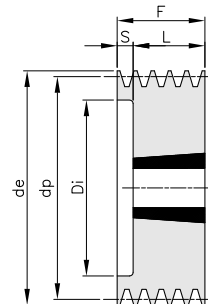

8

Materiale GHISA EN-GJL-200

codice	gole	dp	de	tipo	bussola	foro MAX	Dm	Di	E	F	L	R	S	Kg.
SPZ 63 03	3	63	67	8	1108	28		40	40	22			18	0,50
SPZ 67 03	3	67	71	8	1108	28		42	40	22			18	0,70
SPZ 71 03	3	71	75	8	1108	28		42	40	22			18	0,70
SPZ 75 03	3	75	79	8	1210	32		51	40	25			15	0,80
SPZ 80 03	3	80	84	8	1210	32		51	40	25			15	0,80
SPZ 85 03	3	85	89	8	1610	42		60	40	25			15	0,80
SPZ 90 03	3	90	94	8	1610	42		61	40	25			15	0,90
SPZ 95 03	3	95	99	8	1610	42		66	40	25			15	1,10
SPZ 100 03	3	100	104	8	1610	42		71	40	25			15	1,20
SPZ 106 03	3	106	110	8	1610	42		76	40	25			15	1,40
SPZ 112 03	3	112	116	8	2012	50		83	40	32			8	1,50
SPZ 118 03	3	118	122	8	2012	50		90	40	32			8	1,60
SPZ 125 03	3	125	129	2	2012	50		96	40	32	8			2,00
SPZ 132 03	3	132	136	2	2012	50		103	40	32	8			2,40
SPZ 140 03	3	140	144	2	2010	50		111	40	32	8			2,80
SPZ 150 03	3	150	154	2	2012	50		121	40	32	8			3,40
SPZ 160 03	3	160	164	2	2012	50		131	40	32	8			3,60
SPZ 170 03	3	170	174	3	2012	50		141	40	32	4	4		3,70
SPZ 180 03	3	180	184	6	2012	50	106	151	7	40	32	8		3,70
SPZ 190 03	3	190	194	6	2012	50	112	161	10	40	32	4	4	4,00
SPZ 200 03	3	200	204	5	2012	50	112	171		40	32	4	4	4,30
SPZ 224 03	3	224	228	5	2012	50	112	195		40	32	4	4	4,70
SPZ 250 03	3	250	254	5	2012	50	112	221		40	32	4	4	5,40
SPZ 280 03	3	280	284	4	2517	65	124	251		40	45	2,5	2,5	6,50
SPZ 315 03	3	315	319	4	2517	65	124	286		40	45	2,5	2,5	7,80
SPZ 355 03	3	355	359	4	2517	65	124	326		40	45	2,5	2,5	8,90
SPZ 400 03	3	400	404	4	2517	65	124	371		40	45	2,5	2,5	9,10
SPZ 450 03	3	450	454	4	2517	65	124	421		40	45	2,5	2,5	9,70
SPZ 500 03	3	500	504	4	2517	65	124	471		40	45	2,5	2,5	10,60
SPZ 630 03	3	630	634	4	3020	75	150	601		40	51	5,5	5,5	15,00
SPZ 800 03	3	800	804	4	3020	75	150	771		40	51	5,5	5,5	28,50

PULEGGE A GOLE TRAPEZOIDALI PER BUSSOLA CONICA V-BELTS PULLEYS FOR TAPER BUSHES

SPZ - 4

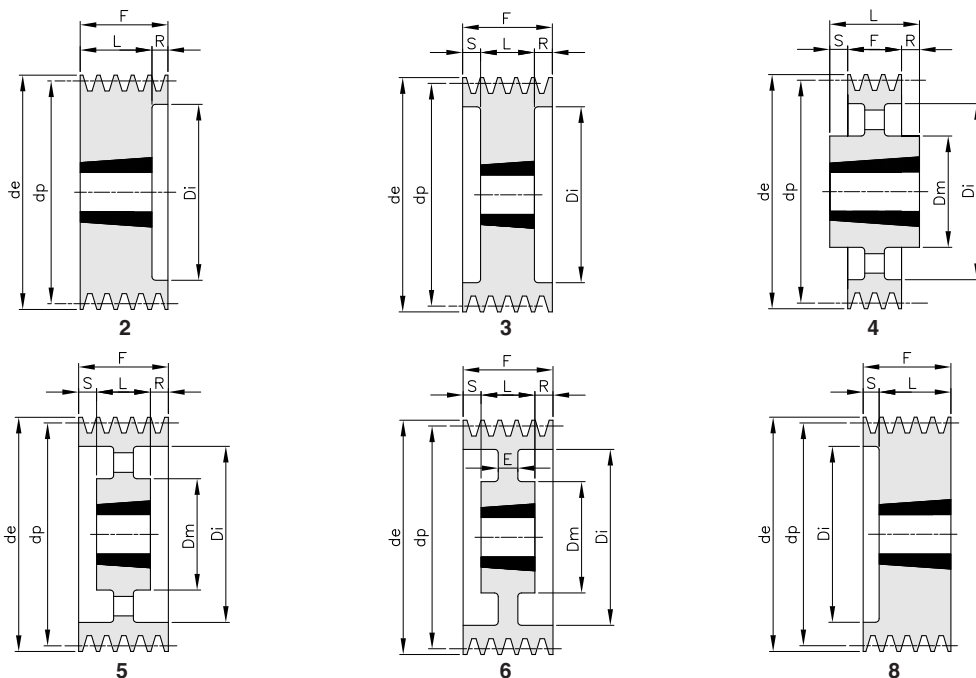

Materiale GHISA EN-GJL-200

codice	gole	dp	de	tipo	bussola	foro MAX	Dm	Di	E	F	L	R	S	Kg.
SPZ 80 04	4	80	84	8	1210	32		51	52	25			27	0,90
SPZ 85 04	4	85	89	8	1610	42		60	52	25			27	1,00
SPZ 90 04	4	90	94	8	1610	42		61	52	25			27	1,10
SPZ 95 04	4	95	99	8	1610	42		66	52	25			27	1,20
SPZ 100 04	4	100	104	8	1610	42		71	52	25			27	1,30
SPZ 106 04	4	106	110	8	1610	42		76	52	25			27	1,40
SPZ 112 04	4	112	116	8	2012	50		83	52	32			20	1,60
SPZ 118 04	4	118	122	8	2012	50		90	52	32			20	1,90
SPZ 125 04	4	125	129	2	2012	50		96	52	32	20			2,20
SPZ 132 04	4	132	136	2	2012	50		103	52	32	20			2,60
SPZ 140 04	4	140	144	2	2012	50		111	52	32	20			3,00
SPZ 150 04	4	150	154	2	2517	65		121	52	45	7			3,60
SPZ 160 04	4	160	164	2	2517	65		131	52	45	7			4,50
SPZ 170 04	4	170	174	2	2517	65		141	52	45	7			4,80
SPZ 180 04	4	180	184	2	2517	65		151	52	45	7			5,00
SPZ 190 04	4	190	194	3	2517	65		161	52	45	3,5	3,5		5,10
SPZ 200 04	4	200	204	6	2517	65	124	171	8	52	45	3,5	3,5	5,20
SPZ 224 04	4	224	228	5	2517	65	124	195		52	45	3,5	3,5	5,90
SPZ 250 04	4	250	254	5	2517	65	124	221		52	45	3,5	3,5	6,60
SPZ 280 04	4	280	284	5	2517	65	124	251		52	45	3,5	3,5	7,20
SPZ 315 04	4	315	319	5	2517	65	124	286		52	45	3,5	3,5	8,50
SPZ 355 04	4	355	359	5	2517	65	124	326		52	45	3,5	3,5	9,40
SPZ 400 04	4	400	404	5	2517	65	124	371		52	45	3,5	3,5	11,20
SPZ 450 04	4	450	454	5	3020	75	146	421		52	45	0,5	0,5	11,60
SPZ 500 04	4	500	504	5	3020	75	146	471		52	51	0,5	0,5	12,40
SPZ 630 04	4	630	634	4	3030	75	146	601		52	76	12	12	18,00
SPZ 800 04	4	800	804	4	3030	75	146	771		52	76	12	12	38,00

PULEGGE A GOLE TRAPEZOIDALI PER BUSSOLA CONICA V-BELTS PULLEYS FOR TAPER BUSHES

SPZ - 5

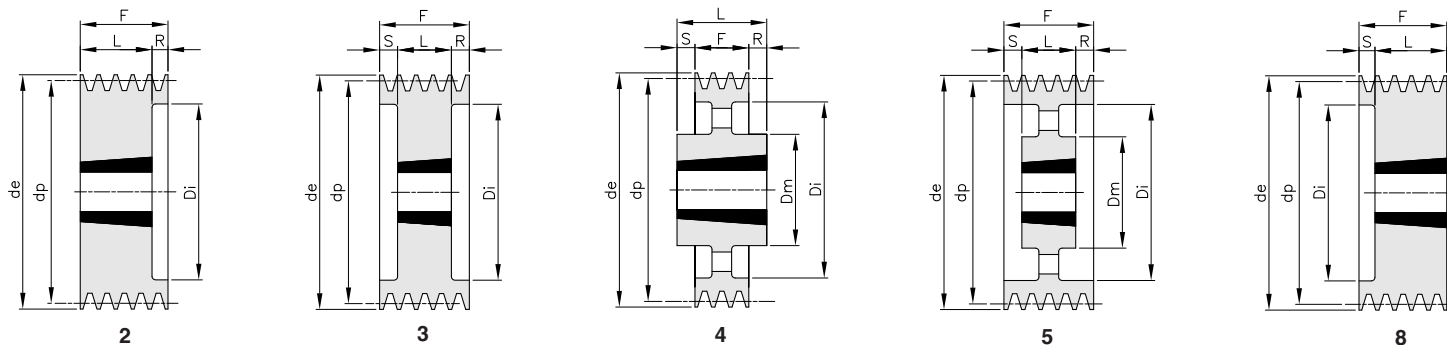

Materiale GHISA EN-GJL-200

codice	gole	dp	de	tipo	bussola	foro MAX	Dm	Di	E	F	L	R	S	Kg.
SPZ 85 05	5	85	89	8	1610	42		60		64	25		39	1,20
SPZ 90 05	5	90	94	8	1610	42		61		64	25		39	1,40
SPZ 95 05	5	95	99	8	1610	42		66		64	25		39	1,50
SPZ 100 05	5	100	104	8	2012	50		71		64	32		32	1,60
SPZ 106 05	5	106	110	8	2012	50		76		64	32		32	1,80
SPZ 112 05	5	112	116	8	2012	50		83		64	32		32	1,90
SPZ 118 05	5	118	122	8	2012	50		90		64	32		32	2,40
SPZ 125 05	5	125	129	8	2012	50		96		64	32		32	2,80
SPZ 132 05	5	132	136	8	2517	65		103		64	45		19	2,80
SPZ 140 05	5	140	144	2	2517	65		111		64	45	19		3,20
SPZ 150 05	5	150	154	2	2517	65		121		64	45	19		3,90
SPZ 160 05	5	160	164	2	2517	65		131		64	45	19		4,70
SPZ 170 05	5	170	174	2	2517	65		141		64	45	19		5,50
SPZ 180 05	5	180	184	2	2517	65		151		64	45	19		6,20
SPZ 190 05	5	190	194	3	2517	65		161		64	45	9,5	9,5	6,40
SPZ 200 05	5	200	204	3	2517	65		171		64	45	9,5	9,5	6,50
SPZ 224 05	5	224	228	5	2517	65	124	195		64	45	9,5	9,5	7,20
SPZ 250 05	5	250	254	5	2517	65	124	221		64	45	9,5	9,5	7,60
SPZ 280 05	5	280	284	5	2517	65	124	251		64	45	9,5	9,5	9,00
SPZ 315 05	5	315	319	5	2517	65	124	286		64	45	9,5	9,5	10,00
SPZ 355 05	5	355	359	5	2517	65	124	326		64	45	9,5	9,5	12,10
SPZ 400 05	5	400	404	5	3020	75	146	371		64	51	6,5	6,5	13,80
SPZ 450 05	5	450	454	5	3020	75	146	421		64	51	6,5	6,5	16,00
SPZ 500 05	5	500	504	4	3030	75	146	471		64	76	6	6	20,50
SPZ 630 05	5	630	634	4	3030	75	146	601		64	76	6	6	27,60
SPZ 800 05	5	800	804	4	3535	90	178	771		64	89	12,5	12,5	44,00

PULEGGE A GOLE TRAPEZOIDALI PER BUSSOLA CONICA V-BELTS PULLEYS FOR TAPER BUSHES

SPZ - 6

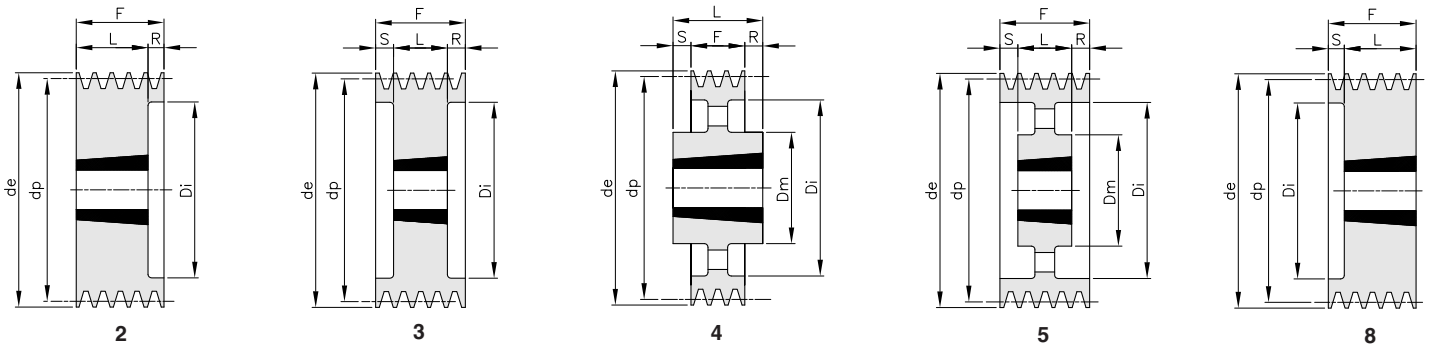

Materiale GHISA EN-GJL-200

codice	gole	dp	de	tipo	bussola	foro MAX	Dm	Di	E	F	L	R	S	Kg.
SPZ 90 06	6	90	94	8	1610	42		61		76	25		51	1,50
SPZ 95 06	6	95	99	8	1610	42		66		76	25		51	1,70
SPZ 100 06	6	100	104	8	2012	50		71		76	32		44	1,80
SPZ 106 06	6	106	110	8	2012	50		76		76	32		44	2,00
SPZ 112 06	6	112	116	8	2012	50		83		76	32		44	2,20
SPZ 118 06	6	118	122	8	2517	65		90		76	45		31	2,40
SPZ 125 06	6	125	129	8	2517	65		96		76	45		31	2,90
SPZ 132 06	6	132	136	8	2517	65		103		76	45		31	3,20
SPZ 140 06	6	140	144	2	2517	65		111		76	45	31		3,50
SPZ 150 06	6	150	154	2	2517	65		121		76	45	31		4,50
SPZ 160 06	6	160	164	2	2517	65		131		76	45	31		5,50
SPZ 170 06	6	170	174	2	2517	65		141		76	45	31		6,50
SPZ 180 06	6	180	184	3	2517	65		151		76	45	15,5	15,5	6,50
SPZ 190 06	6	190	194	3	2517	65		161		76	45	15,5	15,5	6,40
SPZ 200 06	6	200	204	3	2517	65		171		76	45	15,5	15,5	6,20
SPZ 224 06	6	224	228	5	2517	65	124	195		76	45	15,5	15,5	7,10
SPZ 250 06	6	250	254	5	2517	65	124	221		76	45	15,5	15,5	8,30
SPZ 280 06	6	280	284	5	2517	65	124	251		76	45	15,5	15,5	9,90
SPZ 315 06	6	315	319	5	2517	65	124	286		76	45	15,5	15,5	11,50
SPZ 355 06	6	355	359	5	2517	65	124	326		76	45	15,5	15,5	14,00
SPZ 400 06	6	400	404	5	3030	75	146	371		76	76			17,60
SPZ 450 06	6	450	454	5	3030	75	146	421		76	76			21,60
SPZ 500 06	6	500	504	5	3030	75	146	471		76	76			23,00
SPZ 630 06	6	630	634	4	3535	90	175	601		76	89	6,5	6,5	33,00
SPZ 800 06	6	800	804	4	3535	90	178	771		76	89	6,5	6,5	52,00

PULEGGE A GOLE TRAPEZOIDALI PER BUSSOLA CONICA V-BELTS PULLEYS FOR TAPER BUSHES

SPZ - 8

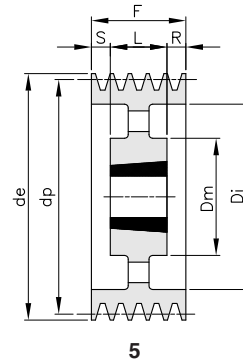
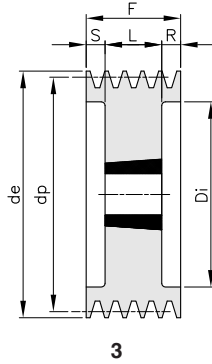

Materiale GHISA EN-GJL-200

codice	gole	dp	de	tipo	bussola	foro MAX	Dm	Di	E	F	L	R	S	Kg.
SPZ 140 08	8	140	144	3	2517	65		111		100	45	27,5	27,5	4,00
SPZ 150 08	8	150	154	3	2517	65		121		100	45	27,5	27,5	5,10
SPZ 160 08	8	160	164	3	2517	65		131		100	45	27,5	27,5	5,60
SPZ 180 08	8	180	184	3	2517	65		151		100	45	27,5	27,5	7,10
SPZ 200 08	8	200	204	3	3020	75		171		100	51	24,5	24,5	9,30
SPZ 224 08	8	224	228	3	3020	75		195		100	51	24,5	24,5	11,80
SPZ 250 08	8	250	254	5	3020	75	146	221		100	51	24,5	24,5	10,50
SPZ 280 08	8	280	284	5	3020	75	146	251		100	51	24,5	24,5	10,80
SPZ 355 08	8	355	359	5	3030	75	146	326		100	76	12	12	16,00
SPZ 400 08	8	400	404	5	3030	75	146	371		100	76	12	12	18,20
SPZ 450 08	8	450	454	5	3535	90	175	421		100	89	5,5	5,5	24,00

PULEGGE A GOLE TRAPEZOIDALI PER BUSSOLA CONICA V-BELTS PULLEYS FOR TAPER BUSHES

SPA - 1

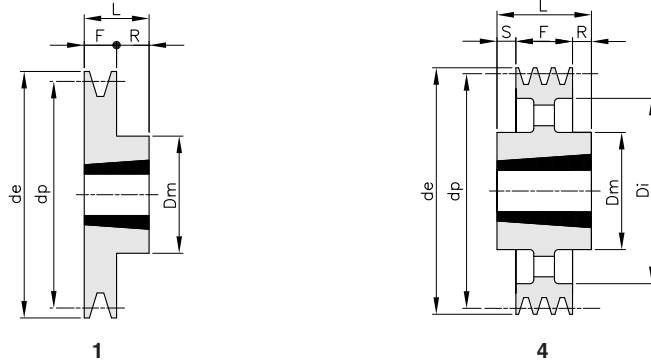

Materiale GHISA EN-GJL-200

codice	gole	dp	de	tipo	bussola	foro MAX	Dm	Di	E	F	L	R	S	Kg.
SPA 63 01	1	63	68,5	1	1008	25	56			20	22	2		0,70
SPA 67 01	1	67	72,5	1	1108	28	56			20	22	2		0,50
SPA 71 01	1	71	76,5	1	1108	28	60			20	22	2		0,50
SPA 75 01	1	75	80,5	1	1108	28	60			20	22	2		0,60
SPA 80 01	1	80	85,5	1	1210	32	75			20	25	5		0,60
SPA 85 01	1	85	90,5	1	1210	32	80			20	25	5		0,70
SPA 90 01	1	90	95,5	1	1210	32	80			20	25	5		0,70
SPA 95 01	1	95	100,5	1	1210	32	85			20	25	5		0,80
SPA 100 01	1	100	105,5	1	1610	42	85			20	25	5		0,90
SPA 106 01	1	106	111,5	1	1610	42	92			20	25	5		1,00
SPA 112 01	1	112	117,5	1	1610	42	92			20	25	5		1,20
SPA 118 01	1	118	123,5	1	1610	42	92			20	25	5		1,30
SPA 125 01	1	125	130,5	1	1610	42	92			20	25	5		1,40
SPA 132 01	1	132	137,5	1	1610	42	92			20	25	5		1,50
SPA 140 01	1	140	145,5	1	1610	42	92			20	25	5		1,60
SPA 150 01	1	150	155,5	1	1610	42	92			20	25	5		1,70
SPA 160 01	1	160	165,5	1	1610	42	92			20	25	5		2,00
SPA 170 01	1	170	175,5	1	1610	42	92			20	25	5		1,80
SPA 180 01	1	180	185,5	4	1610	42	92	145		20	25	5		1,90
SPA 190 01	1	190	195,5	4	1610	42	92	156		20	25	5		2,50
SPA 200 01	1	200	205,5	4	2012	50	108	165		20	32	12		2,80
SPA 212 01	1	212	217,5	4	2012	50	110	177		20	32	12		2,90
SPA 224 01	1	224	229,5	4	2012	50	112	189		20	32	12		3,00
SPA 236 01	1	236	241,5	4	2012	50	112	202		20	32	12		3,20
SPA 250 01	1	250	255,5	4	2012	50	112	215		20	32	6	6	3,60
SPA 280 01	1	280	285,5	4	2012	50	112	245		20	32	12		4,20
SPA 300 01	1	300	305,5	4	2012	50	112	265		20	32	12		4,30
SPA 315 01	1	315	320,5	4	2012	50	112	280		20	32	12		5,20
SPA 355 01	1	355	360,5	4	2012	50	112	320		20	32	12		5,90
SPA 400 01	1	400	405,5	4	2012	50	112	365		20	32	12		6,30
SPA 450 01	1	450	455,5	4	2012	50	112	415		20	32	12		6,80
SPA 500 01	1	500	505,5	4	2517	65	124	465		20	45	25		8,30
SPA 630 01	1	630	635,5	4	2517	65	124	595		20	45	25		12,50

PULEGGE A GOLE TRAPEZOIDALI PER BUSSOLA CONICA

V-BELTS PULLEYS FOR TAPER BUSHES

SPA - 2

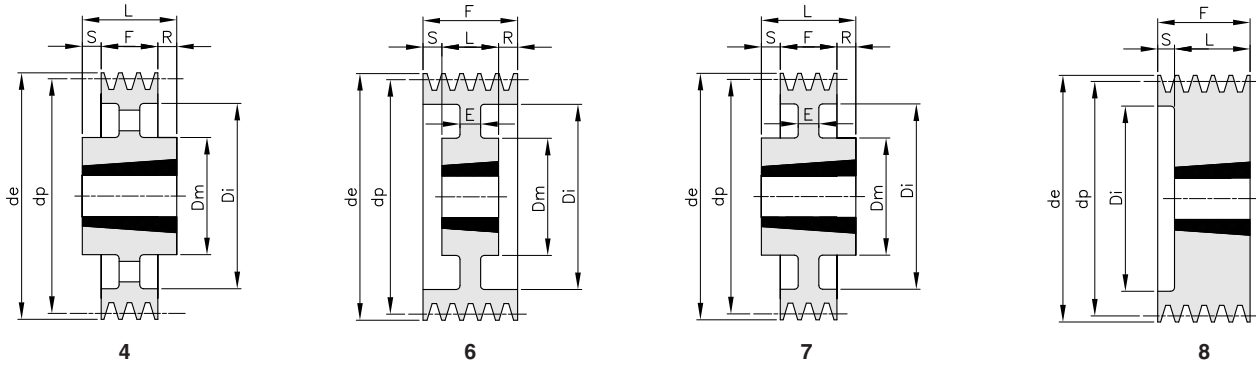

Materiale GHISA EN-GJL-200 / *Materiale Acciaio

codice	gole	dp	de	tipo	bussola	foro MAX	Dm	Di	E	F	L	R	S	Kg.
*SPA 63 02	2	63	68,5	8	1008	25		32,5		35	22		13	0,50
SPA 67 02	2	67	72,5	8	1108	28		37		35	22		13	0,60
SPA 71 02	2	71	76,5	8	1108	28		40		35	22		13	0,60
SPA 75 02	2	75	80,5	8	1108	28		44		35	25		13	0,70
SPA 80 02	2	80	85,5	8	1210	32		50		35	25		10	0,70
SPA 85 02	2	85	90,5	8	1210	32		55		35	25		10	0,80
SPA 90 02	2	90	95,5	8	1610	42		59		35	25		10	0,90
SPA 95 02	2	95	100,5	8	1610	42		63		35	25		10	1,00
SPA 100 02	2	100	105,5	8	1610	42		66		35	25		10	1,00
SPA 106 02	2	106	111,5	8	1610	42		72		35	25		10	1,20
SPA 112 02	2	112	117,5	8	1610	42		78		35	25		10	1,40
SPA 118 02	2	118	123,5	8	1610	42		84		35	25		10	1,70
SPA 125 02	2	125	130,5	8	1610	42		91		35	25		10	1,90
SPA 132 02	2	132	137,5	8	2012	50		98		35	32		3	2,10
SPA 140 02	2	140	145,5	8	2012	50		106		35	32		3	2,60
SPA 150 02	2	150	155,5	8	2012	50		116		35	32		3	3,20
SPA 160 02	2	160	165,5	8	2012	50		125		35	32		3	3,60
SPA 170 02	2	170	175,5	8	2012	50		135		35	32		3	4,00
SPA 180 02	2	180	185,5	6	2012	50	108	146	10	35	32	1,5	1,5	5,00
SPA 190 02	2	190	195,5	6	2012	50	108	156	10	35	32	1,5	1,5	4,40
SPA 200 02	2	200	205,5	7	2517	65	123	163	10	35	45	5	5	4,50
SPA 212 02	2	212	217,5	4	2517	65	123	177		35	45	5	5	4,70
SPA 224 02	2	224	229,5	4	2517	65	124	189		35	45	10		5,00
SPA 236 02	2	236	241,5	4	2517	65	124	202		35	45	10		5,40
SPA 250 02	2	250	255,5	4	2517	65	124	215		35	45	5	5	5,60
SPA 280 02	2	280	285,5	4	2517	65	124	245		35	45	10		6,20
SPA 300 02	2	300	305,5	4	2517	65	124	265		35	45	10		6,80
SPA 315 02	2	315	320,5	4	2517	65	124	280		35	45	10		7,20
SPA 355 02	2	355	360,5	4	2517	65	124	320		35	45	10		9,40
SPA 400 02	2	400	405,5	4	2517	65	124	365		35	45	10		10,00
SPA 450 02	2	450	455,5	4	2517	65	124	415		35	45	10		10,50
SPA 500 02	2	500	505,5	4	2517	65	124	465		35	45	10		11,00
SPA 630 02	2	630	635,5	4	3020	75	159	595		35	51	8	8	20,50

PULEGGE A GOLE TRAPEZOIDALI PER BUSSOLA CONICA V-BELTS PULLEYS FOR TAPER BUSHES

SPA - 3

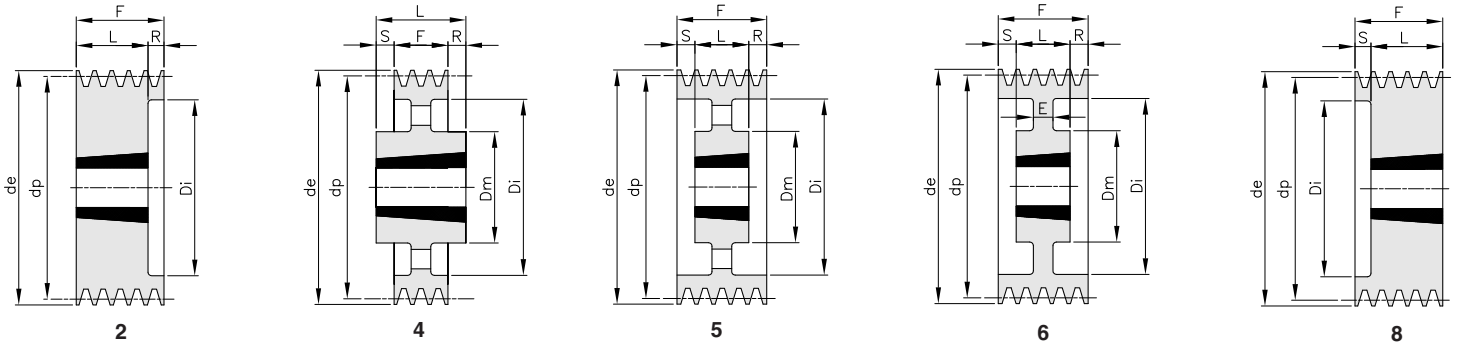

Materiale GHISA EN-GJL-200

codice	gole	dp	de	tipo	bussola	foro MAX	Dm	Di	E	F	L	R	S	Kg.
SPA 71 03	3	71	76,5	8	1108	28		40		50	22		28	0,80
SPA 75 03	3	75	80,5	8	1108	28		44		50	22		28	0,90
SPA 80 03	3	80	85,5	8	1210	32		50		50	25		25	1,10
SPA 85 03	3	85	90,5	8	1210	32		55		50	25		25	1,20
SPA 90 03	3	90	95,5	8	1610	42		59		50	25		25	1,30
SPA 95 03	3	95	100,5	8	1610	42		63		50	25		25	1,50
SPA 100 03	3	100	105,5	2	1610	42		66		50	25	25		1,80
SPA 106 03	3	106	111,5	2	1610	42		72		50	25	25		2,10
SPA 112 03	3	112	117,5	8	2012	50		78		50	32		18	2,30
SPA 118 03	3	118	123,5	2	2012	50		84		50	32	18		2,50
SPA 125 03	3	125	130,5	2	2012	50		91		50	32	18		2,70
SPA 132 03	3	132	137,5	2	2012	50		98		50	32	18		2,90
SPA 140 03	3	140	145,5	8	2517	65		106		50	45		5	3,20
SPA 150 03	3	150	155,5	8	2517	65		116		50	45		5	3,50
SPA 160 03	3	160	165,5	8	2517	65		125		50	45		5	4,50
SPA 170 03	3	170	175,5	8	2517	65		135		50	45		5	5,00
SPA 180 03	3	180	185,5	8	2517	65		146		50	45		5	5,50
SPA 190 03	3	190	195,5	8	2517	65		156		50	45		5	6,30
SPA 200 03	3	200	205,5	6	2517	65	123	165	20	50	45	2,5	2,5	5,80
SPA 212 03	3	212	217,5	5	2517	65	123	177		50	45	2,5	2,5	6,00
SPA 224 03	3	224	229,5	5	2517	65	124	189		50	45	2,5	2,5	6,30
SPA 236 03	3	236	241,5	5	2517	65	124	202		50	45	2,5	2,5	6,60
SPA 250 03	3	250	255,5	5	2517	65	124	215		50	45	2,5	2,5	7,30
SPA 280 03	3	280	285,5	5	2517	65	124	245		50	45	2,5	2,5	8,00
SPA 300 03	3	300	305,5	4	3020	75	159	265		50	51	0,5	0,5	9,10
SPA 315 03	3	315	320,5	4	3020	75	159	280		50	51	0,5	0,5	9,40
SPA 355 03	3	355	360,5	4	3020	75	159	320		50	51	0,5	0,5	11,50
SPA 400 03	3	400	405,5	4	3020	75	159	365		50	51	1		13,30
SPA 450 03	3	450	455,5	4	3020	75	159	415		50	51	1		14,20
SPA 500 03	3	500	505,5	4	3020	75	159	465		50	51	1		16,10
SPA 560 03	3	560	565,5	4	3020	75	159	525		50	51	1		18,00
SPA 630 03	3	630	635,5	4	3020	75	159	595		50	51	1		20,00
SPA 800 03	3	800	805,5	4	3535	90	175	765		50	89	19,5	19,5	34,50
SPA1000 03	3	1000	1005,5	4	3535	90	175	965		50	89	19,5	19,5	49,30

PULEGGE A GOLE TRAPEZOIDALI PER BUSSOLA CONICA V-BELTS PULLEYS FOR TAPER BUSHES

SPA - 4

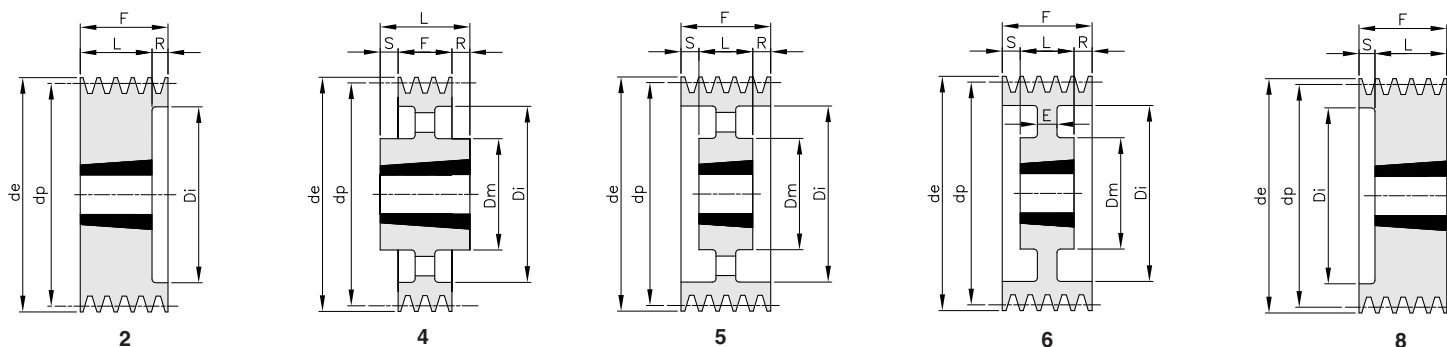

Materiale GHISA EN-GJL-200

codice	gole	dp	de	tipo	bussola	foro MAX	Dm	Di	E	F	L	R	S	Kg.
SPA 90 04	4	90	95,5	8	1615	42		59		65	38		27	1,40
SPA 95 04	4	95	100,5	8	1615	42		63		65	38		27	1,60
SPA 100 04	4	100	105,5	2	1615	42		66		65	38	27		1,80
SPA 106 04	4	106	111,5	8	2012	50		72		65	32		33	2,10
SPA 112 04	4	112	117,5	8	2012	50		78		65	32		33	2,50
SPA 118 04	4	118	123,5	2	2012	50		84		65	32	33		2,80
SPA 125 04	4	125	130,5	2	2012	50		91		65	32	33		3,00
SPA 132 04	4	132	137,5	2	2517	65		98		65	45	20		3,20
SPA 140 04	4	140	145,5	2	2517	65		106		65	45	20		3,50
SPA 150 04	4	150	155,5	2	2517	65		116		65	45	20		3,90
SPA 160 04	4	160	165,5	2	2517	65		125		65	45	20		4,30
SPA 170 04	4	170	175,5	2	2517	65		135		65	45	20		5,80
SPA 180 04	4	180	185,5	2	2517	65		146		65	45	20		6,20
SPA 190 04	4	190	195,5	2	2517	65		156		65	45	20		6,80
SPA 200 04	4	200	205,5	2	3020	75		165		65	51	14		7,50
SPA 212 04	4	212	217,5	2	3020	75		177		65	51	14		8,40
SPA 224 04	4	224	229,5	2	3020	75		189		65	51	14		8,80
SPA 236 04	4	236	241,5	6	3020	75	159	202	20	65	51	14		9,80
SPA 250 04	4	250	255,5	5	3020	75	159	215		65	51	7	7	10,00
SPA 280 04	4	280	285,5	5	3020	75	159	245		65	51	7	7	11,50
SPA 300 04	4	300	305,5	5	3020	75	159	265		65	51	7	7	12,40
SPA 315 04	4	315	320,5	5	3020	75	159	280		65	51	7	7	12,90
SPA 355 04	4	355	360,5	5	3020	75	159	320		65	51	7	7	13,50
SPA 400 04	4	400	405,5	5	3020	75	159	365		65	51	7	7	14,00
SPA 450 04	4	450	455,5	5	3020	75	159	415		65	51	7	7	15,80
SPA 500 04	4	500	505,5	5	3020	75	159	465		65	51	7	7	18,70
SPA 560 04	4	560	565,5	4	3535	90	175	525		65	89	12	12	24,50
SPA 630 04	4	630	635,5	4	3535	90	175	595		65	89	12	12	30,00
SPA 800 04	4	800	805,5	4	3535	90	175	765		65	89	12	12	43,20
SPA1000 04	4	1000	1005,5	4	4040	100	210	965		65	102	18,5	18,5	69,00

PULEGGE A GOLE TRAPEZOIDALI PER BUSSOLA CONICA V-BELTS PULLEYS FOR TAPER BUSHES

SPA - 5

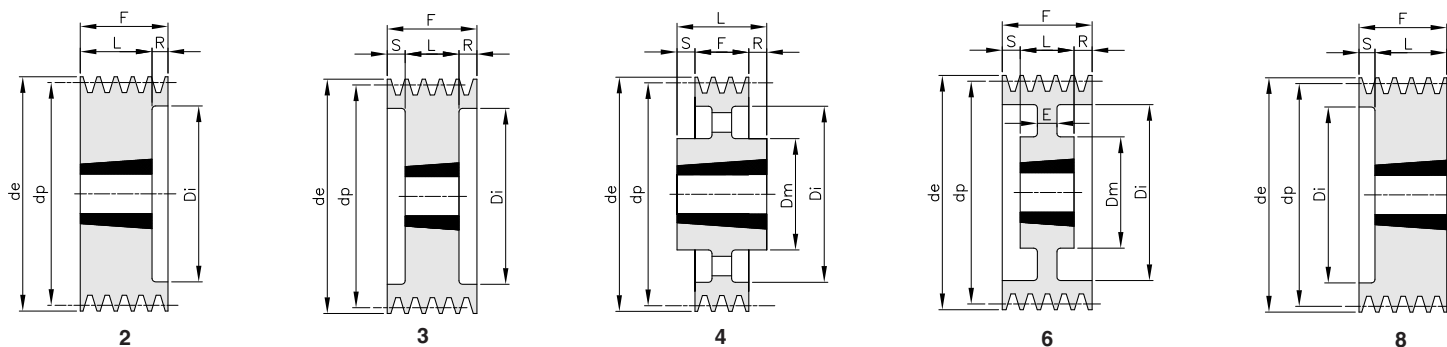

Materiale GHISA EN-GJL-200

codice	gole	dp	de	tipo	bussola	foro MAX	Dm	Di	E	F	L	R	S	Kg.
SPA 100 05	5	100	105,5	2	1615	42		66		80	38	42		2,10
SPA 106 05	5	106	111,5	8	2012	50		72		80	32		48	2,30
SPA 112 05	5	112	117,5	8	2012	50		78		80	32		48	2,50
SPA 118 05	5	118	123,5	2	2012	50		84		80	32	48		2,80
SPA 125 05	5	125	130,5	3	2012	50		91		80	32	24	24	3,00
SPA 132 05	5	132	137,5	3	2517	65		98		80	45	17,5	17,5	3,50
SPA 140 05	5	140	145,5	3	2517	65		106		80	45	17,5	17,5	3,90
SPA 150 05	5	150	155,5	3	2517	65		116		80	45	17,5	17,5	4,40
SPA 160 05	5	160	165,5	3	2517	65		125		80	45	17,5	17,5	5,70
SPA 170 05	5	170	175,5	3	2517	65		135		80	45	17,5	17,5	6,30
SPA 180 05	5	180	185,5	3	3020	75		146		80	51	14,5	14,5	6,90
SPA 190 05	5	190	195,5	2	3020	75		156		80	51	29		7,70
SPA 200 05	5	200	205,5	3	3020	75		168		80	51	14,5	14,5	9,00
SPA 212 05	5	212	217,5	2	3020	75		177		80	51	29		9,80
SPA 224 05	5	224	229,5	2	3020	75		189		80	51	29		10,20
SPA 236 05	5	236	241,5	2	3020	75		202		80	51	29		11,20
SPA 250 05	5	250	255,5	6	3020	75	159	215	20	80	51	14,5	14,5	12,40
SPA 280 05	5	280	285,5	4	3535	90	175	245		80	89	4,5	4,5	15,00
SPA 300 05	5	300	305,5	4	3535	90	175	265		80	89	4,5	4,5	16,50
SPA 315 05	5	315	320,5	4	3535	90	175	280		80	89	4,5	4,5	18,10
SPA 355 05	5	355	360,5	4	3535	90	175	320		80	89	4,5	4,5	19,20
SPA 400 05	5	400	405,5	4	3535	90	175	365		80	89	4,5	4,5	21,50
SPA 450 05	5	450	455,5	4	3535	90	175	415		80	89	4,5	4,5	23,00
SPA 500 05	5	500	505,5	4	3535	90	175	465		80	89	4,5	4,5	26,50
SPA 560 05	5	560	565,5	4	3535	90	175	525		80	89	4,5	4,5	30,00
SPA 630 05	5	630	635,5	4	3535	90	175	595		80	89	4,5	4,5	34,50
SPA 800 05	5	800	805,5	4	4040	100	210	765		80	102	11	11	55,50
SPA1000 05	5	1000	1005,5	4	4545	110	242	965		80	114	17	17	80,00

PULEGGE A GOLE TRAPEZOIDALI PER BUSSOLA CONICA V-BELTS PULLEYS FOR TAPER BUSHES

SPA - 6

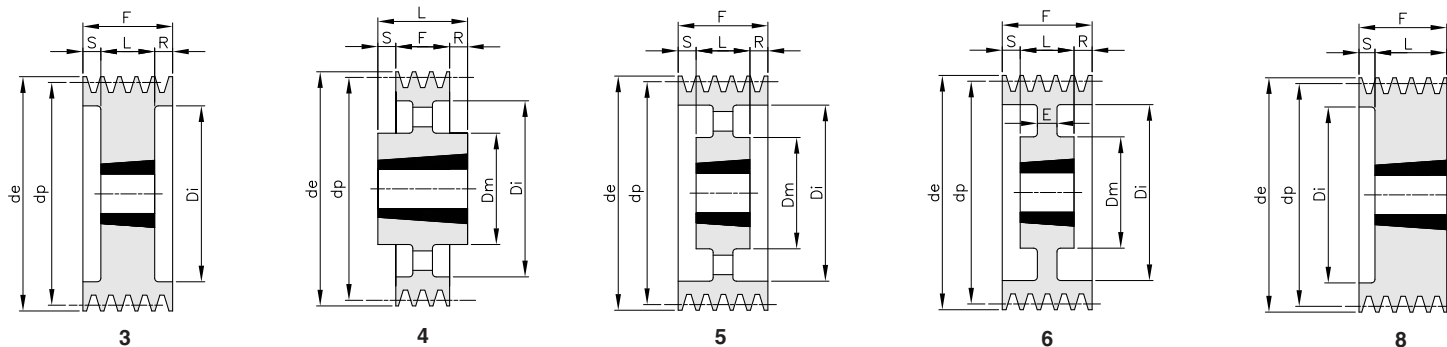

Materiale GHISA EN-GJL-200

codice	gole	dp	de	tipo	bussola	foro MAX	Dm	Di	E	F	L	R	S	Kg.
SPA 100 06	6	100	105,5	3	1610	42		66		95	25	40	30	2,50
SPA 106 06	6	106	111,5	8	2012	50		72		95	32		63	2,60
SPA 112 06	6	112	117,5	8	2012	50		78		95	32		63	2,90
SPA 118 06	6	118	123,5	8	2012	50		84		95	32		63	3,30
SPA 125 06	6	125	130,5	3	2012	50		91		95	32	31,5	31,5	3,50
SPA 132 06	6	132	137,5	3	2517	65		98		95	45	25	25	3,80
SPA 140 06	6	140	145,5	3	2517	65		106		95	45	25	25	4,10
SPA 150 06	6	150	155,5	3	2517	65		116		95	45	25	25	4,90
SPA 160 06	6	160	165,5	3	2517	65		125		95	45	25	25	5,70
SPA 180 06	6	180	185,5	3	3020	75		146		95	51	22	22	8,50
SPA 200 06	6	200	205,5	3	3020	75		165		95	51	22	22	11,00
SPA 224 06	6	224	229,5	3	3020	75		189		95	51	22	22	13,40
SPA 236 06	6	236	241,5	3	3020	75		202		95	51	22	22	14,90
SPA 250 06	6	250	255,5	6	3020	75	155	215	20	95	51	22	22	16,40
SPA 280 06	6	280	285,5	5	3535	90	175	245		95	89	3	3	17,30
SPA 315 06	6	315	320,5	5	3535	90	175	280		95	89	3	3	19,50
SPA 355 06	6	355	360,5	5	3535	90	175	320		95	89	3	3	23,20
SPA 400 06	6	400	405,5	5	3535	90	175	365		95	89	3	3	22,40
SPA 450 06	6	450	455,5	5	3535	90	175	415		95	89	3	3	29,90
SPA 500 06	6	500	505,5	5	3535	90	175	465		95	89	3	3	30,40
SPA 560 06	6	560	565,5	5	3535	90	175	525		95	89	3	3	40,20
SPA 630 06	6	630	635,5	4	4040	100	210	595		95	102	3,5	3,5	48,00
SPA 800 06	6	800	805,5	4	4040	100	210	765		95	102	3,5	3,5	72,00
SPA1000 06	6	1000	1005,5	4	4545	110	242	965		95	114	9,5	9,5	97,00

PULEGGE A GOLE TRAPEZOIDALI PER BUSSOLA CONICA V-BELTS PULLEYS FOR TAPER BUSHES

SPB - 1

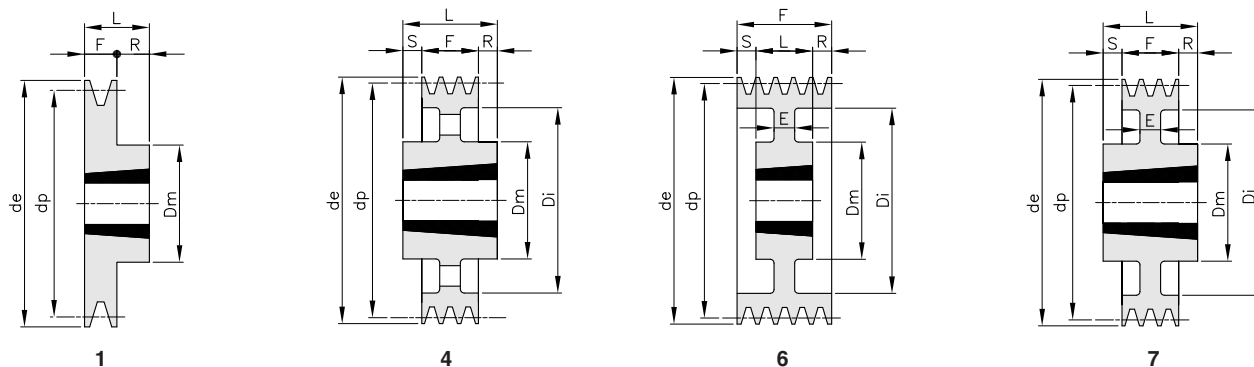

Materiale GHISA EN-GJL-200

codice	gole	dp	de	tipo	bussola	foro MAX	Dm	Di	E	F	L	R	S	Kg.
SPB 100 01	1	100	107	1	1610	42				25	25			0,90
SPB 106 01	1	106	113	1	1610	42				25	25			1,00
SPB 112 01	1	112	119	1	1610	42				25	25			1,20
SPB 118 01	1	118	125	1	1610	42				25	25			1,30
SPB 125 01	1	125	132	1	1610	42				25	25			1,50
SPB 132 01	1	132	139	1	1610	42				25	25			1,70
SPB 140 01	1	140	147	1	1610	42				25	25			1,80
SPB 150 01	1	150	157	1	1610	42				25	25			2,10
SPB 160 01	1	160	167	1	1610	42				25	25			2,50
SPB 170 01	1	170	177	1	1610	42				25	25			2,90
SPB 180 01	1	180	187	6	1610	42	90	132	12	25	25			3,20
SPB 190 01	1	190	197	7	2012	50	104	147	12	25	32	3,5	3,5	3,80
SPB 200 01	1	200	207	4	2012	50	104	157		25	32	3,5	3,5	4,20
SPB 212 01	1	212	219	4	2012	50	104	169		25	32	3,5	3,5	4,40
SPB 224 01	1	224	231	4	2012	50	104	181		25	32	3,5	3,5	4,70
SPB 236 01	1	236	243	4	2012	50	104	193		25	32	3,5	3,5	4,60
SPB 250 01	1	250	257	4	2012	50	104	207		25	32	3,5	3,5	5,30
SPB 280 01	1	280	287	4	2012	50	104	237		25	32	3,5	3,5	6,00
SPB 300 01	1	300	307	4	2012	50	104	258		25	32	3,5	3,5	6,50
SPB 315 01	1	315	322	4	2012	50	104	272		25	32	3,5	3,5	7,00

PULEGGE A GOLE TRAPEZOIDALI PER BUSSOLA CONICA V-BELTS PULLEYS FOR TAPER BUSHES

SPB - 2

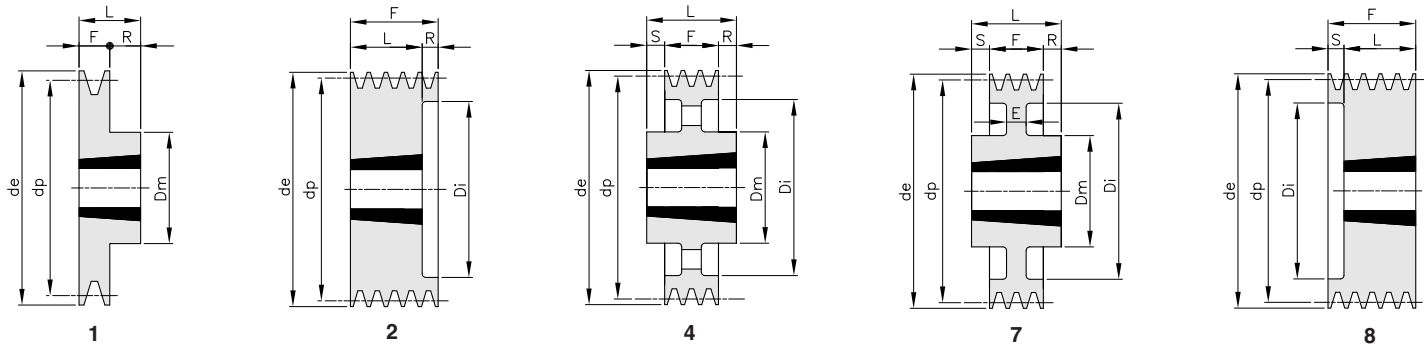

Materiale GHISA EN-GJL-200

codice	gole	dp	de	tipo	bussola	foro MAX	Dm	Di	E	F	L	R	S	Kg.
SPB 100 02	2	100	107	8	1610	42		62		44	25		19	1,40
SPB 106 02	2	106	113	8	1610	42		67		44	25		19	1,60
SPB 112 02	2	112	119	8	1610	42		72		44	25		19	1,70
SPB 118 02	2	118	125	2	1610	42		78		44	25	19		1,80
SPB 125 02	2	125	132	2	2012	50		82		44	32	12		1,90
SPB 132 02	2	132	139	2	2012	50		89		44	32	12		2,50
SPB 140 02	2	140	147	2	2012	50		97		44	32	12		2,70
SPB 150 02	2	150	157	2	2012	50		107		44	32	12		3,20
SPB 160 02	2	160	167	2	2012	50		117		44	32	12		3,80
SPB 170 02	2	170	177	2	2012	50		127		44	32	12		4,80
SPB 180 02	2	180	187	1	2517	65	120			44	45	1		6,30
SPB 190 02	2	190	197	1	2517	65	120			44	45	1		7,20
SPB 200 02	2	200	207	1	2517	65	117			44	45	1		8,20
SPB 212 02	2	212	219	7	2517	65	117	169	15	44	45	1		5,40
SPB 224 02	2	224	231	4	2517	65	117	181		44	45	1		5,90
SPB 236 02	2	236	243	4	2517	65	117	193		44	45	1		6,60
SPB 250 02	2	250	257	4	2517	65	125	207		44	45	1		7,10
SPB 280 02	2	280	287	4	2517	65	125	237		44	45	1		7,40
SPB 300 02	2	300	307	4	2517	65	125	257		44	45	1		8,60
SPB 315 02	2	315	322	4	2517	65	125	272		44	45	1		9,90
SPB 335 02	2	335	342	4	2517	65	125	292		44	45	1		11,30
SPB 355 02	2	355	362	4	3020	75	144	312		44	51	3,5	3,5	12,00
SPB 400 02	2	400	407	4	3020	75	150	357		44	51	3,5	3,5	13,00
SPB 450 02	2	450	457	4	3020	75	150	407		44	51	3,5	3,5	13,50
SPB 500 02	2	500	507	4	3020	75	150	457		44	51	3,5	3,5	15,00
SPB 560 02	2	560	567	4	3030	75	150	517		44	76	28	4	17,00
SPB 630 02	2	630	637	4	3030	75	150	587		44	76	16	16	19,30

PULEGGE A GOLE TRAPEZOIDALI PER BUSSOLA CONICA V-BELTS PULLEYS FOR TAPER BUSHES

SPB - 3

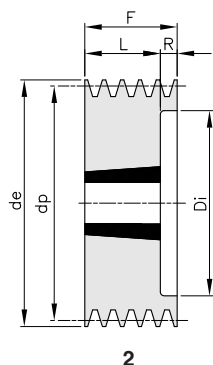

2

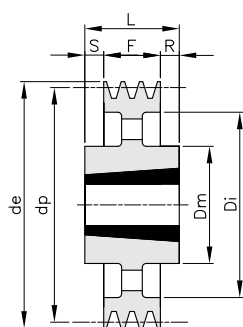

4

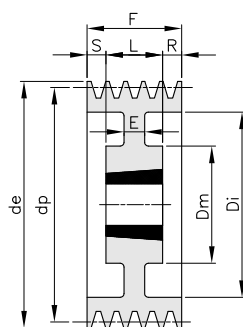

6

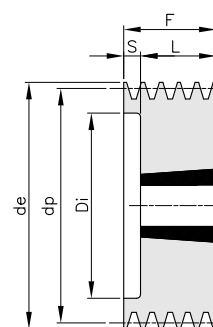

8

Materiale GHISA EN-GJL-200

codice	gole	dp	de	tipo	bussola	foro MAX	Dm	Di	E	F	L	R	S	Kg.
SPB 100 03	3	100	107	8	1610	42		62		63	25		38	1,90
SPB 106 03	3	106	113	8	1610	42		67		63	25		38	2,20
SPB 112 03	3	112	119	8	1610	42		72		63	25		38	2,40
SPB 118 03	3	118	125	2	1610	42		78		63	25	38		2,60
SPB 125 03	3	125	132	2	2012	50		82		63	32	31		3,20
SPB 132 03	3	132	139	2	2012	50		89		63	32	31		3,20
SPB 140 03	3	140	147	2	2012	50		97		63	32	31		3,60
SPB 150 03	3	150	157	2	2517	65		107		63	45	18		4,00
SPB 160 03	3	160	167	2	2517	65		117		63	45	18		4,50
SPB 170 03	3	170	177	2	2517	65		127		63	45	18		5,30
SPB 180 03	3	180	187	2	2517	65		137		63	45	18		5,90
SPB 190 03	3	190	197	2	2517	65		147		63	45	18		6,50
SPB 200 03	3	200	207	2	2517	65		157		63	45	18		6,70
SPB 212 03	3	212	219	6	2517	65	117	169	15	63	45	18		6,90
SPB 224 03	3	224	231	4	2517	65	117	181		63	45	18		7,50
SPB 236 03	3	236	243	4	2517	65	117	193		63	45	18		8,80
SPB 250 03	3	250	257	4	3020	75	144	207		63	51	12		10,20
SPB 280 03	3	280	287	4	3020	75	144	237		63	51	6	6	11,30
SPB 300 03	3	300	307	4	3020	75	144	257		63	51	6	6	12,30
SPB 315 03	3	315	322	4	3020	75	144	272		63	51	6	6	13,50
SPB 335 03	3	335	342	4	3020	75	144	292		63	51	6	6	14,70
SPB 355 03	3	355	362	4	3020	75	144	312		63	51	6	6	15,90
SPB 400 03	3	400	407	4	3535	90	175	357		63	89	13	13	18,80
SPB 450 03	3	450	457	4	3535	90	175	407		63	89	26		22,50
SPB 500 03	3	500	507	4	3535	90	175	457		63	89	26		24,00
SPB 560 03	3	560	567	4	3535	90	175	517		63	89	26		30,00
SPB 630 03	3	630	637	4	3535	90	175	587		63	89	26		33,50
SPB 710 03	3	710	717	4	3535	90	175	664		63	89	13	13	35,00
SPB 800 03	3	800	807	4	3535	90	175	754		63	89	13	13	38,00
SPB 900 03	3	900	907	4	3535	90	175	854		63	89	13	13	48,00
SPB1000 03	3	1000	1007	4	4040	100	210	954		63	102	19,5	19,5	55,00
SPB1250 03	3	1250	1257	4	4040	100	210	1204		63	102	19,5	19,5	100,00

PULEGGE A GOLE TRAPEZOIDALI PER BUSSOLA CONICA V-BELTS PULLEYS FOR TAPER BUSHES

SPB - 4

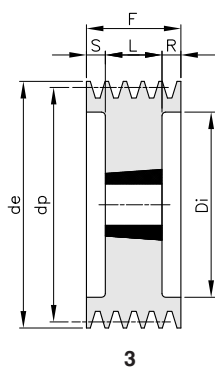

3

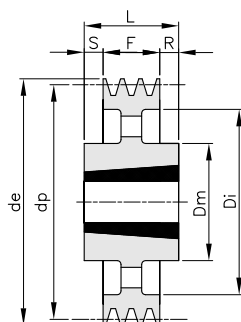

4

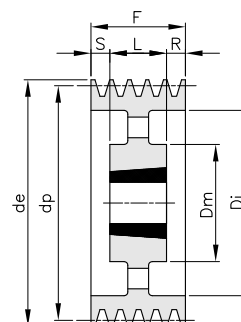

5

Materiale GHISA EN-GJL-200

codice	gole	dp	de	tipo	bussola	foro MAX	Dm	Di	E	F	L	R	S	Kg.
SPB 125 04	4	125	132	3	2012	50		82		82	32	25	25	3,50
SPB 132 04	4	132	139	3	2012	50		89		82	32	25	25	3,70
SPB 140 04	4	140	147	3	2517	65		100		82	45	18,5	18,5	4,30
SPB 150 04	4	150	157	3	2517	65		107		82	45	18,5	18,5	4,60
SPB 160 04	4	160	167	3	2517	65		117		82	45	18,5	18,5	5,20
SPB 170 04	4	170	177	3	2517	65		127		82	45	18,5	18,5	6,10
SPB 180 04	4	180	187	3	2517	65		137		82	45	18,5	18,5	7,20
SPB 190 04	4	190	197	3	2517	65		147		82	45	18,5	18,5	7,90
SPB 200 04	4	200	207	3	3020	75		157		82	51	15,5	15,5	9,10
SPB 212 04	4	212	219	3	3020	75		169		82	51	15,5	15,5	10,00
SPB 224 04	4	224	231	3	3020	75		181		82	51	15,5	15,5	11,50
SPB 236 04	4	236	243	3	3020	75		193		82	51	15,5	15,5	12,80
SPB 250 04	4	250	257	5	3020	75	144	207		82	51	15,5	15,5	13,50
SPB 280 04	4	280	287	5	3020	75	144	237		82	51	15,5	15,5	14,10
SPB 300 04	4	300	307	4	3535	90	175	257		82	89	7		15,80
SPB 315 04	4	315	322	4	3535	90	175	272		82	89	3,5	3,5	17,50
SPB 335 04	4	335	342	4	3535	90	175	292		82	89	3,5	3,5	18,40
SPB 355 04	4	355	362	4	3535	90	175	312		82	89	3,5	3,5	19,20
SPB 400 04	4	400	407	4	3535	90	175	357		82	89	3,5	3,5	21,00
SPB 450 04	4	450	457	4	3535	90	175	407		82	89	7		25,00
SPB 500 04	4	500	507	4	3535	90	175	457		82	89	7		27,00
SPB 560 04	4	560	567	4	3535	90	175	517		82	89	7		33,20
SPB 630 04	4	630	637	4	3535	90	175	587		82	89	7		36,00
SPB 710 04	4	710	717	4	3535	90	175	664		82	89	3,5	3,5	42,00
SPB 800 04	4	800	807	4	4040	100	210	754		82	102	10	10	53,50
SPB 900 04	4	900	907	4	4040	100	210	854		82	102	10	10	62,00
SPB1000 04	4	1000	1007	4	4040	100	210	954		82	102	16	10	68,00
SPB1250 04	4	1250	1257	4	4545	110	242	1204		82	114	16	16	114,50

PULEGGE A GOLE TRAPEZOIDALI PER BUSSOLA CONICA V-BELTS PULLEYS FOR TAPER BUSHES

SPB - 5

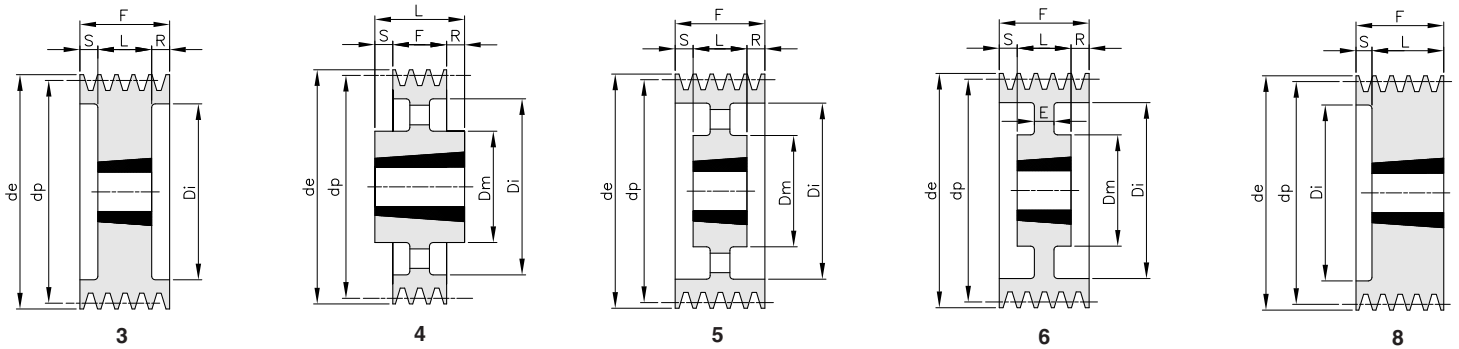

Materiale GHISA EN-GJL-200

codice	gole	dp	de	tipo	bussola	foro MAX	Dm	Di	E	F	L	R	S	Kg.
SPB 125 05	5	125	132	8	2012	50		87		101	32		69	4,20
SPB 132 05	5	132	139	8	2517	65		94		101	45		56	4,40
SPB 140 05	5	140	147	3	2517	65		97		101	45	28	28	4,80
SPB 150 05	5	150	157	3	2517	65		107		101	45	28	28	5,40
SPB 160 05	5	160	167	3	2517	65		117		101	45	28	28	6,20
SPB 170 05	5	170	177	3	3020	75		127		101	51	25	25	7,10
SPB 180 05	5	180	187	3	3020	75		137		101	51	25	25	7,50
SPB 190 05	5	190	197	3	3020	75		147		101	51	25	25	8,50
SPB 200 05	5	200	207	3	3020	75		157		101	51	25	25	9,60
SPB 212 05	5	212	219	3	3020	75		169		101	51	25	25	11,50
SPB 224 05	5	224	231	3	3020	75		181		101	51	25	25	13,00
SPB 236 05	5	236	243	3	3535	90		193		101	89	6	6	16,20
SPB 250 05	5	250	257	3	3535	90		207		101	89	6	6	17,20
SPB 280 05	5	280	287	6	3535	90	175	237	25	101	89	6	6	18,50
SPB 300 05	5	300	307	5	3535	90	175	257		101	89	6	6	19,00
SPB 315 05	5	315	322	5	3535	90	175	272		101	89	6	6	19,50
SPB 335 05	5	335	342	5	3535	90	175	292		101	89	6	6	20,40
SPB 355 05	5	355	362	4	3535	90	175	312		101	89	6	6	21,50
SPB 400 05	5	400	407	4	3535	90	175	357		101	89	6	6	24,50
SPB 450 05	5	450	457	4	3535	90	175	407		101	89	12		29,00
SPB 500 05	5	500	507	4	3535	90	175	457		101	89	12		31,50
SPB 560 05	5	560	567	4	4040	100	210	517		101	102	1		36,00
SPB 630 05	5	630	637	4	4040	100	210	587		101	102	1		48,50
SPB 710 05	5	710	717	4	4040	100	210	664		101	102	1		52,00
SPB 800 05	5	800	807	4	4040	100	210	754		101	102	1		56,20
SPB 900 05	5	900	907	4	4040	100	210	854		101	102	1		76,00
SPB1000 05	5	1000	1007	4	4545	110	242	954		101	114	6,5	6,5	85,30
SPB1250 05	5	1250	1257	4	4545	110	242	1204		101	114	6,5	6,5	150,70

PULEGGE A GOLE TRAPEZOIDALI PER BUSSOLA CONICA V-BELTS PULLEYS FOR TAPER BUSHES

SPB - 6

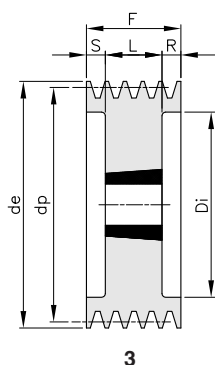

3

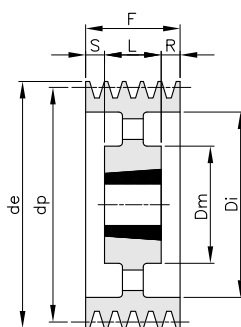

5

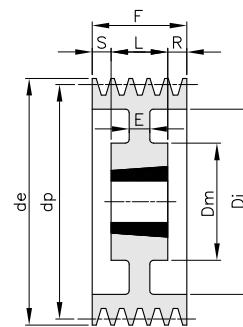

6

Materiale GHISA EN-GJL-200

codice	gole	dp	de	tipo	bussola	foro MAX	Dm	Di	E	F	L	R	S	Kg.
SPB 140 06	6	140	147	3	2517	65		100		120	45	37,5	37,5	5,80
SPB 150 06	6	150	157	3	2517	65		107		120	45	37,5	37,5	6,80
SPB 160 06	6	160	167	3	3020	75		118		120	51	34,5	34,5	6,90
SPB 170 06	6	170	177	3	3020	75		127		120	51	34,5	34,5	8,10
SPB 180 06	6	180	187	3	3020	75		137		120	51	34,5	34,5	8,20
SPB 190 06	6	190	197	3	3020	75		147		120	51	34,5	34,5	9,40
SPB 200 06	6	200	207	3	3020	75		157		120	51	34,5	34,5	10,50
SPB 212 06	6	212	219	3	3535	90		169		120	89	15,5	15,5	14,50
SPB 224 06	6	224	231	3	3535	90		181		120	89	15,5	15,5	17,50
SPB 236 06	6	236	243	3	3535	90		193		120	89	15,5	15,5	20,00
SPB 250 06	6	250	257	3	3535	90		207		120	89	15,5	15,5	21,50
SPB 280 06	6	280	287	6	3535	90	175	237	25	120	89	15,5	15,5	22,10
SPB 300 06	6	300	307	5	3535	90	175	257		120	89	15,5	15,5	23,50
SPB 315 06	6	315	322	5	3535	90	175	272		120	89	15,5	15,5	24,60
SPB 335 06	6	335	342	5	3535	90	175	292		120	89	15,5	15,5	26,30
SPB 355 06	6	355	362	5	3535	90	175	312		120	89	15,5	15,5	28,40
SPB 400 06	6	400	407	5	3535	90	175	357		120	89	15,5	15,5	32,90
SPB 450 06	6	450	457	5	4040	100	210	407		120	102	18		36,50
SPB 500 06	6	500	507	5	4040	100	210	457		120	102	18		40,00
SPB 560 06	6	560	567	5	4040	100	210	517		120	102	18		47,50
SPB 630 06	6	630	637	5	4040	100	210	587		120	102	18		55,00
SPB 710 06	6	710	717	5	4040	100	210	664		120	102	9	9	62,50
SPB 800 06	6	800	807	5	4545	110	242	754		120	114	3	3	71,00
SPB 900 06	6	900	907	5	4545	110	242	854		120	114	3	3	83,70
SPB1000 06	6	1000	1007	5	4545	110	242	954		120	114	3	3	100,40
SPB1250 06	6	1250	1257	5	4545	110	242	1204		120	114	3	3	136,00

PULEGGE A GOLE TRAPEZOIDALI PER BUSSOLA CONICA V-BELTS PULLEYS FOR TAPER BUSHES

SPB - 8

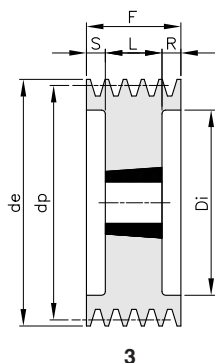

3

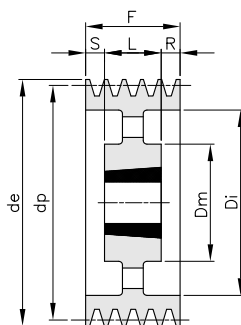

5

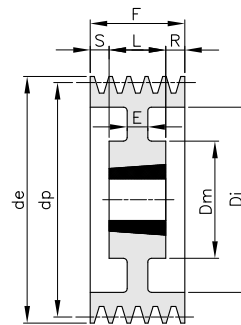

6

Materiale GHISA EN-GJL-200

codice	gole	dp	de	tipo	bussola	foro MAX	Dm	Di	E	F	L	R	S	Kg.
SPB 140 08	8	140	147	3	2517	65		97		158	45	56,5	56,5	7,00
SPB 160 08	8	160	167	3	3020	75		118		158	51	53,5	53,5	11,60
SPB 170 08	8	170	177	3	3030	75		127		158	76	41	41	12,50
SPB 180 08	8	180	187	3	3030	75		137		158	76	41	41	13,70
SPB 190 08	8	190	197	3	3030	75		147		158	76	41	41	15,60
SPB 200 08	8	200	207	3	3535	90		157		158	89	34,5	34,5	17,60
SPB 212 08	8	212	219	3	3535	90		169		158	89	34,5	34,5	20,50
SPB 224 08	8	224	231	3	3535	90		181		158	89	34,5	34,5	22,50
SPB 236 08	8	236	243	3	3535	90		193		158	89	34,5	34,5	24,00
SPB 250 08	8	250	257	3	3535	90		207		158	89	34,5	34,5	26,50
SPB 280 08	8	280	287	6	3535	90	175	237	25	158	89	34,5	34,5	28,00
SPB 300 08	8	300	307	6	3535	90	175	257	25	158	89	34,5	34,5	30,10
SPB 315 08	8	315	322	5	3535	90	175	272		158	89	34,5	34,5	31,20
SPB 335 08	8	335	342	5	3535	90	175	292		158	89	34,5	34,5	33,50
SPB 355 08	8	355	362	5	3535	90	175	312		158	89	34,5	34,5	35,70
SPB 400 08	8	400	407	5	4040	100	210	357		158	102	28	28	37,00
SPB 450 08	8	450	457	5	4040	100	210	407		158	102	28	28	42,00
SPB 500 08	8	500	507	5	4040	100	210	457		158	102	28	28	46,50
SPB 560 08	8	560	567	5	4545	110	242	517		158	114	22	22	58,00
SPB 630 08	8	630	637	5	4545	110	242	587		158	114	22	22	64,00
SPB 710 08	8	710	717	5	4545	110	242	664		158	114	22	22	72,80
SPB 800 08	8	800	807	5	4545	110	242	754		158	114	22	22	92,00
SPB 900 08	8	900	907	5	4545	110	242	854		158	114	22	22	115,00
SPB1000 08	8	1000	1007	5	5050	125	267	954		158	127	15,5	15,5	140,00
SPB1250 08	8	1250	1257	5	5050	125	267	1204		158	127	15,5	15,5	204,00

PULEGGE A GOLE TRAPEZOIDALI PER BUSSOLA CONICA V-BELTS PULLEYS FOR TAPER BUSHES

SPB - 10

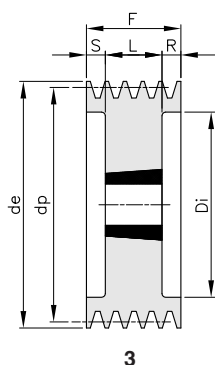

3

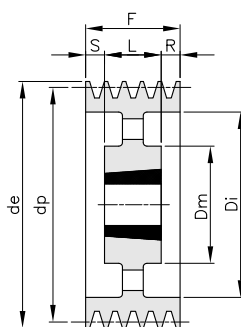

5

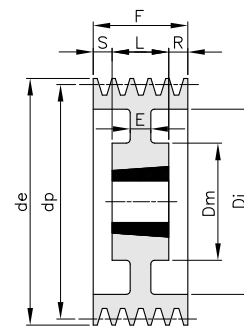

6

Materiale GHISA EN-GJL-200

codice	gole	dp	de	tipo	bussola	foro MAX	Dm	Di	E	F	L	R	S	Kg.
SPB 224 10	10	224	231	3	3535	90		181		196	89	53,5	53,5	22,50
SPB 236 10	10	236	243	3	3535	90		193		196	89	53,5	53,5	25,00
SPB 250 10	10	250	257	3	3535	90		207		196	89	53,5	53,5	29,00
SPB 280 10	10	280	287	6	3535	90	175	237	30	196	89	53,5	53,5	31,50
SPB 315 10	10	315	322	6	3535	90	175	272	30	196	89	53,5	53,5	35,00
SPB 335 10	10	335	342	5	4040	100	210	292		196	102	47	47	37,00
SPB 355 10	10	355	362	5	4040	100	210	312		196	102	47	47	38,50
SPB 400 10	10	400	407	5	4040	100	210	357		196	102	47	47	40,50
SPB 450 10	10	450	457	5	4545	110	242	407		196	114	41	41	53,50
SPB 500 10	10	500	507	5	4545	110	242	457		196	114	41	41	58,00
SPB 560 10	10	560	567	5	4545	110	242	517		196	114	41	41	64,70
SPB 630 10	10	630	637	5	4545	110	242	587		196	114	41	41	72,00
SPB 710 10	10	710	717	5	4545	110	242	664		196	114	41	41	82,40
SPB 800 10	10	800	807	5	4545	110	242	754		196	114	41	41	103,00
SPB 900 10	10	900	907	5	5050	125	267	854		196	127	34,5	34,5	131,50
SPB1000 10	10	1000	1007	5	5050	125	267	954		196	127	34,5	34,5	153,00

PULEGGE A GOLE TRAPEZOIDALI PER BUSSOLA CONICA V-BELTS PULLEYS FOR TAPER BUSHES

SPC - 3

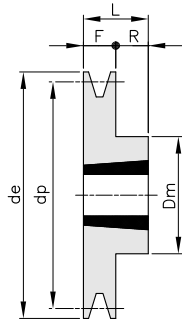

1

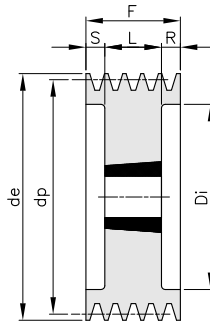

3

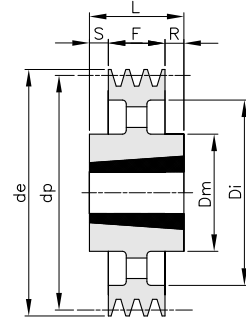

4

Materiale GHISA EN-GJL-200

codice	gole	dp	de	tipo	bussola	foro MAX	Dm	Di	E	F	L	R	S	Kg.
SPC 200 03	3	200	209,6	3	2517	65		144		85	45	20	20	10,20
SPC 212 03	3	212	221,6	3	3020	75		156		85	51	17	17	11,00
SPC 224 03	3	224	233,6	3	3020	75		168		85	51	17	17	12,00
SPC 236 03	3	236	245,6	3	3020	75		180		85	51	17	17	13,00
SPC 250 03	3	250	259,6	3	3020	75		194		85	51	17	17	15,50
SPC 265 03	3	265	274,6	1	3535	90	175			85	89	4		17,20
SPC 280 03	3	280	289,6	1	3535	90	175			85	89	4		19,40
SPC 300 03	3	300	309,6	4	3535	90	175	244		85	89	2	2	22,60
SPC 315 03	3	315	324,6	4	3535	90	175	259		85	89	2	2	22,50
SPC 335 03	3	335	344,6	4	3535	90	175	279		85	89	2	2	23,50
SPC 355 03	3	355	364,6	4	3535	90	175	299		85	89	2	2	24,80
SPC 375 03	3	375	384,6	4	3535	90	175	319		85	89	2	2	25,50
SPC 400 03	3	400	409,6	4	3535	90	175	344		85	89	2	2	26,40
SPC 425 03	3	425	434,6	4	3535	90	175	369		85	89	2	2	27,00
SPC 450 03	3	450	459,6	4	3535	90	175	394		85	89	2	2	28,60
SPC 475 03	3	475	484,6	4	3535	90	175	419		85	89	2	2	30,00
SPC 500 03	3	500	509,6	4	3535	90	175	444		85	89	2	2	31,90
SPC 530 03	3	530	539,6	4	3535	90	175	474		85	89	2	2	34,50
SPC 560 03	3	560	569,6	4	3535	90	175	504		85	89	2	2	37,00
SPC 630 03	3	630	639,6	4	4040	100	210	574		85	102	8,5	8,5	44,50
SPC 800 03	3	800	809,6	4	4545	110	242	737		85	114	14,5	14,5	65,00
SPC1000 03	3	1000	1009,6	4	5050	125	267	937		85	127	21	21	93,00
SPC1250 03	3	1250	1259,6	4	5050	125	267	1187		85	127	21	21	101,00

PULEGGE A GOLE TRAPEZOIDALI PER BUSSOLA CONICA V-BELTS PULLEYS FOR TAPER BUSHES

SPC - 4

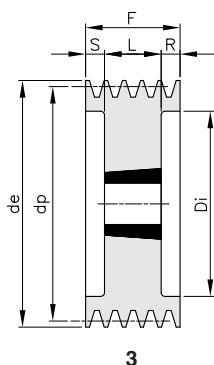

3

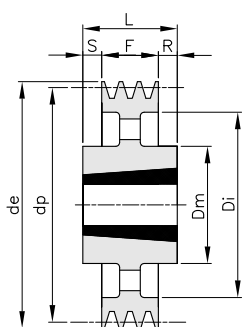

4

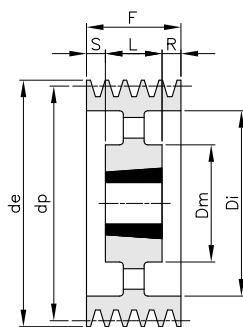

5

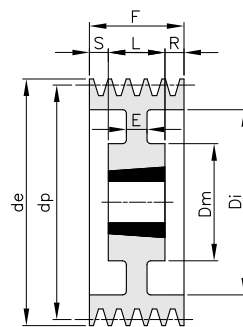

6

Materiale GHISA EN-GJL-200

codice	gole	dp	de	tipo	bussola	foro MAX	Dm	Di	E	F	L	R	S	Kg.
SPC 200 04	4	200	209,6	3	3020	75		144		111	51	30	30	12,50
SPC 212 04	4	212	221,6	3	3020	75		156		111	51	30	30	13,50
SPC 224 04	4	224	233,6	3	3535	90		168		111	89	11	11	15,00
SPC 236 04	4	236	245,6	3	3535	90		180		111	89	11	11	18,20
SPC 250 04	4	250	259,6	3	3535	90		194		111	89	11	11	21,70
SPC 265 04	4	265	274,6	3	3535	90		209		111	89	11	11	23,00
SPC 280 04	4	280	289,6	6	3535	90	175	224	18	111	89	11	11	24,10
SPC 300 04	4	300	309,6	6	3535	90	175	244	20	111	89	11	11	25,00
SPC 315 04	4	315	324,6	5	3535	90	175	259		111	89	11	11	26,40
SPC 335 04	4	335	344,6	5	3535	90	175	279		111	89	11	11	27,50
SPC 355 04	4	355	364,6	5	3535	90	175	299		111	89	11	11	29,30
SPC 375 04	4	375	384,6	5	3535	90	175	319		111	89	11	11	31,00
SPC 400 04	4	400	409,6	5	3535	90	175	344		111	89	11	11	32,80
SPC 425 04	4	425	434,6	5	3535	90	175	369		111	89	11	11	33,40
SPC 450 04	4	450	459,6	5	3535	90	175	394		111	89	11	11	36,80
SPC 475 04	4	475	484,6	5	3535	90	175	419		111	89	11	11	38,00
SPC 500 04	4	500	509,6	5	3535	90	175	444		111	89	11	11	40,00
SPC 530 04	4	530	539,6	5	4040	100	210	474		111	102	4,5	4,5	45,00
SPC 560 04	4	560	569,6	5	4040	100	210	504		111	102	4,5	4,5	50,00
SPC 630 04	4	630	639,6	4	4545	110	242	574		111	114	1,5	1,5	58,00
SPC 710 04	4	710	719,6	4	5050	125	267	654		111	127	8	8	64,00
SPC 800 04	4	800	809,6	4	5050	125	267	737		111	127	8	8	76,50
SPC1000 04	4	1000	1009,6	4	5050	125	267	937		111	127	8	8	105,00
SPC1250 04	4	1250	1259,6	4	5050	125	267	1187		111	127	8	8	178,00

PULEGGE A GOLE TRAPEZOIDALI PER BUSSOLA CONICA

V-BELTS PULLEYS FOR TAPER BUSHES

SPC - 5

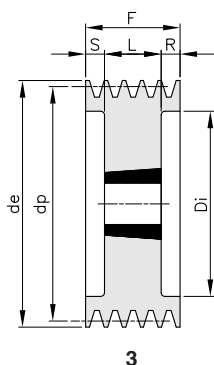

3

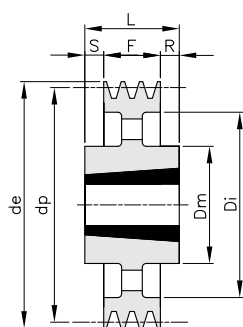

4

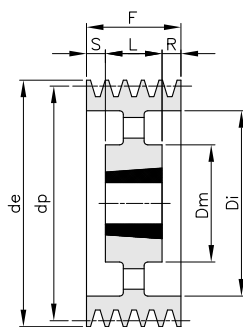

5

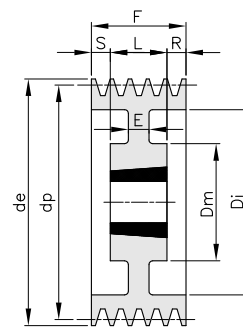

6

Materiale GHISA EN-GJL-200

codice	gole	dp	de	tipo	bussola	foro MAX	Dm	Di	E	F	L	R	S	Kg.
SPC 200 05	5	200	209,6	3	3535	90		144		136	89	23,5	23,5	14,70
SPC 212 05	5	212	221,6	3	3535	90		156		136	89	23,5	23,5	15,00
SPC 224 05	5	224	233,6	3	3535	90		168		136	89	23,5	23,5	17,20
SPC 236 05	5	236	245,6	3	3535	90		180		136	89	23,5	23,5	20,20
SPC 250 05	5	250	259,6	3	3535	90		194		136	89	23,5	23,5	23,50
SPC 265 05	5	265	274,6	3	3535	90		209		136	89	23,5	23,5	25,50
SPC 280 05	5	280	289,6	3	3535	90		224		136	89	23,5	23,5	27,20
SPC 300 05	5	300	309,6	6	3535	90	175	244	20	136	89	23,5	23,5	28,50
SPC 315 05	5	315	324,6	5	3535	90	175	259		136	89	23,5	23,5	29,50
SPC 335 05	5	335	344,6	5	3535	90	175	279		136	89	23,5	23,5	31,00
SPC 355 05	5	355	364,6	5	3535	90	175	299		136	89	23,5	23,5	33,50
SPC 375 05	5	375	384,6	5	3535	90	175	319		136	89	23,5	23,5	36,00
SPC 400 05	5	400	409,6	5	3535	90	175	344		136	89	23,5	23,5	37,00
SPC 425 05	5	425	434,6	5	3535	90	175	369		136	89	23,5	23,5	43,00
SPC 450 05	5	450	459,6	5	4040	100	210	394		136	102	17	17	46,00
SPC 475 05	5	475	484,6	5	4040	100	210	419		136	102	17	17	50,30
SPC 500 05	5	500	509,6	5	4040	100	210	444		136	102	17	17	54,00
SPC 530 05	5	530	539,6	5	4545	110	240	474		136	114	11	11	57,50
SPC 560 05	5	560	569,6	5	4545	110	242	504		136	114	11	11	61,00
SPC 630 05	5	630	639,6	5	5050	125	267	574		136	127	4,5	4,5	75,00
SPC 710 05	5	710	719,6	5	5050	125	267	654		136	127	4,5	4,5	79,00
SPC 800 05	5	800	809,6	5	5050	125	267	737		136	127	4,5	4,5	96,50
SPC1000 05	5	1000	1009,6	5	5050	125	267	937		136	127	4,5	4,5	139,00
SPC1250 05	5	1250	1259,6	5	5050	125	267	1187		136	127	4,5	4,5	196,00

PULEGGE A GOLE TRAPEZOIDALI PER BUSSOLA CONICA V-BELTS PULLEYS FOR TAPER BUSHES

SPC - 6

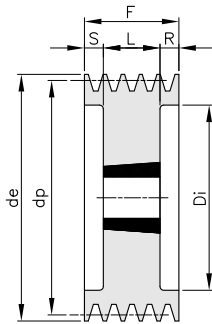

3

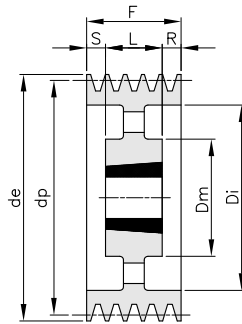

5

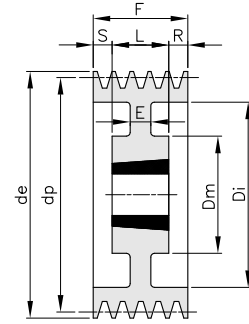

6

Materiale GHISA EN-GJL-200

codice	gole	dp	de	tipo	bussola	foro MAX	Dm	Di	E	F	L	R	S	Kg.
SPC 200 06	6	200	209,6	3	3535	90		144		162	89	36,5	36,5	17,50
SPC 212 06	6	212	221,6	3	3535	90		156		162	89	36,5	36,5	19,00
SPC 224 06	6	224	233,6	3	3535	90		168		162	89	36,5	36,5	21,00
SPC 236 06	6	236	245,6	3	3535	90		180		162	89	36,5	36,5	23,00
SPC 250 06	6	250	259,6	3	3535	90		194		162	89	36,5	36,5	26,00
SPC 265 06	6	265	274,6	3	3535	90		209		162	89	36,5	36,5	27,00
SPC 280 06	6	280	289,6	6	3535	90	175	224	20	162	89	36,5	36,5	29,00
SPC 300 06	6	300	309,6	6	3535	90	175	244	20	162	89	36,5	36,5	31,50
SPC 315 06	6	315	324,6	5	3535	90	175	259		162	89	36,5	36,5	33,20
SPC 335 06	6	335	344,6	5	3535	90	175	279		162	89	36,5	36,5	35,00
SPC 355 06	6	355	364,6	5	3535	90	175	299		162	89	36,5	36,5	37,00
SPC 375 06	6	375	384,6	5	4040	100	210	319		162	102	30	30	42,50
SPC 400 06	6	400	409,6	5	4040	100	210	344		162	102	30	30	47,50
SPC 425 06	6	425	434,6	5	4040	100	210	369		162	102	30	30	55,60
SPC 450 06	6	450	459,6	5	4545	110	242	394		162	114	24	24	62,50
SPC 475 06	6	475	484,6	5	4545	110	242	419		162	114	24	24	65,00
SPC 500 06	6	500	509,6	5	4545	110	242	444		162	114	24	24	68,20
SPC 530 06	6	530	539,6	5	5050	125	265	474		162	127	17,5	17,5	73,00
SPC 560 06	6	560	569,6	5	5050	125	267	504		162	127	17,5	17,5	86,00
SPC 630 06	6	630	639,6	5	5050	125	267	574		162	127	17,5	17,5	96,00
SPC 710 06	6	710	719,6	5	5050	125	267	654		162	127	17,5	17,5	102,00
SPC 800 06	6	800	809,6	5	5050	125	267	737		162	127	17,5	17,5	120,00
SPC1000 06	6	1000	1009,6	5	5050	125	267	937		162	127	17,5	17,5	160,00
SPC1250 06	6	1250	1259,6	5	5050	125	267	1187		162	127	17,5	17,5	232,70

PULEGGE A GOLE TRAPEZOIDALI PER BUSSOLA CONICA V-BELTS PULLEYS FOR TAPER BUSHES

SPC - 8

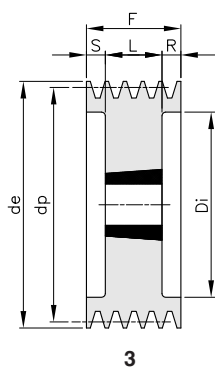

3

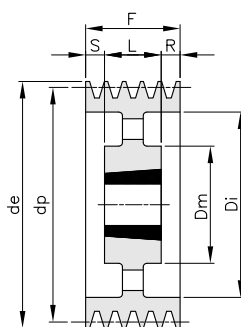

5

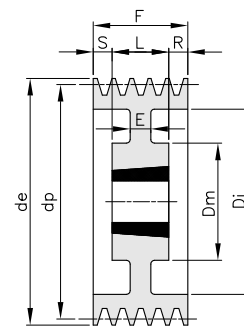

6

Materiale GHISA EN-GJL-200

codice	gole	dp	de	tipo	bussola	foro MAX	Dm	Di	E	F	L	R	S	Kg.
SPC 200 08	8	200	209,6	3	3535	90		144		213	89	62	62	17,90
SPC 212 08	8	212	221,6	3	3535	90		156		213	89	62	62	24,00
SPC 224 08	8	224	233,6	3	3535	90		168		213	89	62	62	25,00
SPC 236 08	8	236	245,6	3	3535	90		180		213	89	62	62	27,00
SPC 250 08	8	250	259,6	3	3535	90		194		213	89	62	62	30,50
SPC 265 08	8	265	274,6	3	3535	90		209		213	89	62	62	34,50
SPC 280 08	8	280	289,6	3	3535	90		224		213	89	62	62	38,50
SPC 300 08	8	300	309,6	3	4040	100		244		213	102	55,5	55,5	47,50
SPC 315 08	8	315	324,6	3	4040	100		259		213	102	55,5	55,5	51,00
SPC 335 08	8	335	344,6	6	4040	100	210	279	50	213	102	55,5	55,5	44,50
SPC 355 08	8	355	364,6	5	4040	100	210	299		213	102	55,5	55,5	57,00
SPC 375 08	8	375	384,6	5	4545	110	242	319		213	114	49,5	49,5	62,00
SPC 400 08	8	400	409,6	5	4545	110	242	344		213	114	49,5	49,5	66,50
SPC 425 08	8	425	434,6	5	4545	110	242	369		213	114	49,5	49,5	75,00
SPC 450 08	8	450	459,6	5	5050	125	267	394		213	127	43	43	80,50
SPC 475 08	8	475	484,6	5	5050	125	267	419		213	127	43	43	85,50
SPC 500 08	8	500	509,6	5	5050	125	267	444		213	127	43	43	90,20
SPC 530 08	8	530	539,6	5	5050	125	267	474		213	127	43	43	92,50
SPC 560 08	8	560	569,6	5	5050	125	267	504		213	127	43	43	109,00
SPC 630 08	8	630	639,6	5	5050	125	267	574		213	127	43	43	120,20
SPC 710 08	8	710	719,6	5	5050	125	267	654		213	127	43	43	124,70
SPC 800 08	8	800	809,6	5	5050	125	267	737		213	127	43	43	148,00
SPC1000 08	8	1000	1009,6	5	5050	125	267	937		213	127	43	43	188,20
SPC1250 08	8	1250	1259,6	5	5050	125	267	1187		213	127	43	43	260,00

PULEGGE A GOLE TRAPEZOIDALI PER BUSSOLA CONICA V-BELTS PULLEYS FOR TAPER BUSHES

SPC - 10

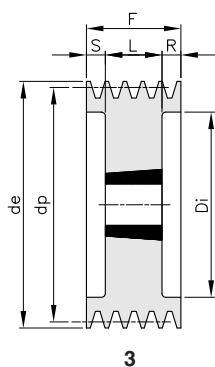

3

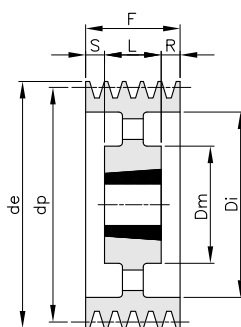

5

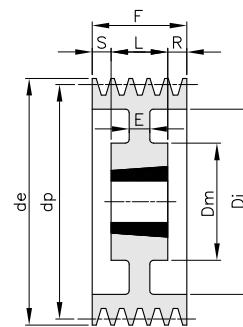

6

Materiale GHISA EN-GJL-200

codice	gole	dp	de	tipo	bussola	foro MAX	Dm	Di	E	F	L	R	S	Kg.
SPC 250 10	10	250	259,6	3	4040	100		194		264	102	81	81	39,60
SPC 280 10	10	280	289,6	3	4040	100		224		264	102	81	81	51,40
SPC 300 10	10	300	309,6	3	4545	110		244		264	114	75	75	57,90
SPC 315 10	10	315	324,6	3	4545	110		259		264	114	75	75	72,00
SPC 335 10	10	335	344,6	3	4545	110		279		264	114	75	75	76,50
SPC 355 10	10	355	364,6	3	4545	110		299		264	114	75	75	83,40
SPC 400 10	10	400	409,6	6	5050	125	267	344	70	264	127	68,5	68,5	80,50
SPC 450 10	10	450	459,6	5	5050	125	267	394		264	127	68,5	68,5	100,90
SPC 500 10	10	500	509,6	5	5050	125	267	444		264	127	68,5	68,5	114,00
SPC 560 10	10	560	569,6	5	5050	125	267	504		264	127	68,5	68,5	125,00
SPC 630 10	10	630	639,6	5	5050	125	267	574		264	127	68,5	68,5	145,00
SPC 710 10	10	710	719,6	5	5050	125	267	654		264	127	68,5	68,5	165,00
SPC 800 10	10	800	809,6	5	5050	125	267	737		264	127	68,5	68,5	182,00
SPC1000 10	10	1000	1009,6	5	5050	125	267	937		264	127	68,5	68,5	240,00
SPC1250 10	10	1250	1259,6	5	5050	125	267	1187		264	127	68,5	68,5	280,00

CINGHIE TRAPEZOIDALI A SEZIONE CLASSICA

CLASSICAL V-BELTS

Introduzione - Introduction

Le cinghie trapezoidali a sezione classica trovano ampia applicazione nel settore industriale ed agricolo e sono utilizzabili su tutte le pulegge trapezoidali normalmente in commercio.

The classical section V-belts are widely used in industrial and agricultural sectors and can be used on all trapezoidal pulleys generally distributed on the market.

Descrizione e caratteristiche - Description and features

- Le cinghie a sezione classica sono costruite secondo le norme ISO 4184 / DIN 2215
- Armatura di cavi in poliestere ad allungamento ridotto
- Rivestimento esterno molto robusto a fianchi ricoperti
- Resistenza agli oli minerali ed ai climi tropicali
- Antistatiche (conforme alla norma ISO 1813)
- Temperatura d'esercizio da -20° a $+70^{\circ}$

- The classical section belts are made according to ISO 4184 / DIN 2215
- Reinforced polyester cables with reduced elongation
- Outer covering very robust with side covered
- Resistance to mineral oils and tropical climates
- Antistatic (according to ISO 1813)
- Operating temperature from -20° to $+70^{\circ}$

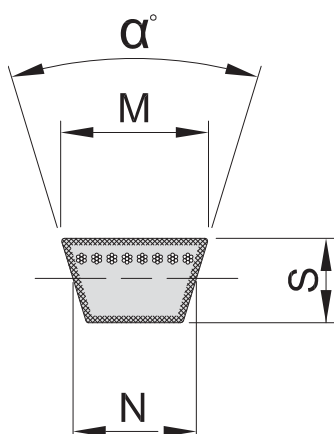
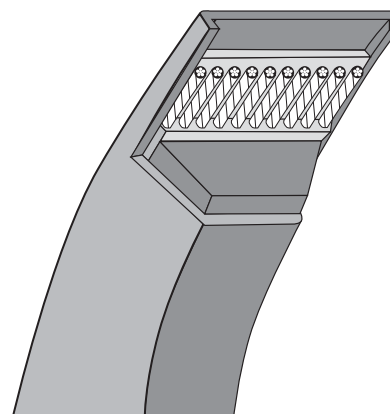

Dimensioni cinghia Dimension of V-belts				
codice	α gradi	M mm	S mm	N mm
Z (mm)	40°	10,0	6	8,5
A (mm)	40°	13,0	8	11,0
B (mm)	40°	17,0	11	14,0
C (mm)	40°	22,0	14	19,0
D (mm)	40°	32,0	19	27,0
E (mm)	40°	40,0	25	32,0

CINGHIE TRAPEZOIDALI A SEZIONE CLASSICA

CLASSICAL V-BELTS

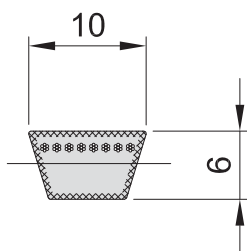

Z



Z

codice	sviluppo interno mm	Kg.
Z 12 1/2	318	0,02
Z 14	355	0,02
Z 16	410	0,03
Z 17	432	0,03
Z 17 1/4	440	0,03
Z 17 1/2	445	0,03
Z 18	460	0,03
Z 19	480	0,03
Z 19 1/2	500	0,03
Z 20	508	0,03
Z 20 1/2	520	0,03
Z 21	533	0,03
Z 21 1/4	535	0,03
Z 21 3/4	555	0,04
Z 22	560	0,04
Z 22 1/4	565	0,04
Z 23	585	0,04
Z 23 3/4	605	0,04
Z 24	610	0,04
Z 25	635	0,04
Z 25 1/2	650	0,04
Z 26	660	0,04
Z 27	685	0,04
Z 27 1/2	698	0,04
Z 28	710	0,04
Z 28 1/2	725	0,05
Z 29	730	0,05
Z 29 1/2	750	0,05
Z 30	762	0,05
Z 30 1/2	775	0,05
Z 30 3/4	785	0,05
Z 31	790	0,05
Z 31 1/2	800	0,05
Z 32	815	0,05
Z 33	840	0,05
Z 33 1/2	852	0,05
Z 34	865	0,05
Z 34 1/4	870	0,05
Z 34 1/2	876	0,05
Z 35	890	0,06
Z 35 1/2	900	0,06
Z 36	915	0,06
Z 36 3/4	935	0,06
Z 37	940	0,06
Z 38	965	0,06
Z 38 1/4	975	0,06
Z 38 1/2	978	0,06
Z 39	1000	0,06
Z 40	1016	0,06
Z 40 1/2	1030	0,06
Z 41	1040	0,06
Z 41 1/2	1050	0,06
Z 42	1070	0,07
Z 43	1090	0,07
Z 43 1/4	1100	0,07
Z 44	1120	0,07
Z 45	1143	0,07
Z 46	1180	0,07
Z 48	1225	0,07
Z 49	1245	0,07
Z 50	1270	0,07

codice	sviluppo interno mm	Kg.
Z 51	1300	0,08
Z 52	1320	0,08
Z 53	1346	0,08
Z 54	1371	0,08
Z 55	1400	0,09
Z 56	1422	0,09
Z 57	1450	0,09
Z 59	1499	0,09
Z 59 1/2	1515	0,09
Z 60	1520	0,09
Z 61	1549	0,09
Z 62	1575	0,10
Z 63	1600	0,10
Z 64	1620	0,10
Z 65	1651	0,10
Z 66	1675	0,10
Z 67	1702	0,10
Z 68 1/2	1735	0,10
Z 69	1750	0,10
Z 71	1803	0,11
Z 72	1829	0,11

CINGHIE TRAPEZOIDALI A SEZIONE CLASSICA

CLASSICAL V-BELTS

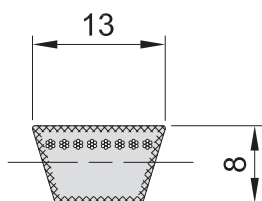

A

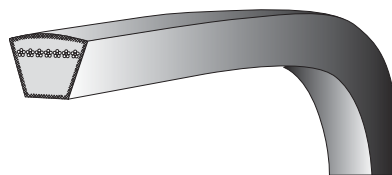

A

codice	sviluppo interno mm	Kg.
A 15	382	0,05
A 16	407	0,05
A 17	432	0,05
A 18	457	0,05
A 19	480	0,05
A 20	508	0,06
A 21	535	0,06
A 21 1/4	541	0,06
A 21 3/4	552	0,06
A 22	560	0,07
A 23	587	0,07
A 23 1/2	600	0,07
A 24	610	0,07
A 25	637	0,07
A 25 1/2	647	0,07
A 26	660	0,08
A 26 1/2	670	0,08
A 27	686	0,08
A 28	710	0,08
A 29	737	0,08
A 29 1/2	750	0,08
A 30	762	0,09
A 30 1/2	775	0,09
A 31	787	0,09
A 31 1/2	800	0,09
A 32	813	0,09
A 32 1/2	825	0,09
A 33	838	0,10
A 33 1/4	847	0,10
A 33 1/2	850	0,10
A 34	863	0,10
A 34 1/2	875	0,10
A 35	890	0,10
A 36	914	0,10
A 37	940	0,11
A 37 1/2	953	0,11
A 38	965	0,11
A 38 1/2	978	0,11
A 39	990	0,11
A 40	1016	0,11
A 40 1/2	1030	0,12
A 41	1041	0,12
A 42	1067	0,12
A 43	1092	0,12
A 43 1/2	1105	0,12
A 44	1120	0,13
A 44 1/2	1132	0,13
A 45	1143	0,13
A 46	1168	0,13
A 47	1194	0,13
A 48	1220	0,14
A 49	1250	0,14
A 50	1270	0,14
A 51	1300	0,15
A 51 1/2	1307	0,15
A 52	1320	0,15
A 52 1/2	1337	0,15
A 53	1346	0,15
A 53 1/4	1355	0,15
A 53 3/4	1367	0,15
A 54	1372	0,15

codice	sviluppo interno mm	Kg.
A 55	1400	0,16
A 56	1422	0,16
A 57	1450	0,16
A 58	1475	0,16
A 59	1500	0,17
A 60	1525	0,17
A 61	1550	0,17
A 62	1575	0,18
A 63	1600	0,18
A 64	1625	0,18
A 65	1650	0,18
A 66	1676	0,19
A 67	1700	0,19
A 68	1725	0,19
A 69	1750	0,19
A 70	1775	0,20
A 71	1800	0,20
A 72	1825	0,20
A 73	1854	0,20
A 74	1880	0,20
A 75	1905	0,21
A 76	1930	0,21
A 77	1956	0,22
A 78	1980	0,22
A 79	2000	0,22
A 80	2032	0,22
A 81	2060	0,23
A 82	2083	0,23
A 83	2100	0,23
A 83 1/2	2120	0,23
A 84	2134	0,24
A 85	2160	0,24
A 86	2187	0,24
A 87	2212	0,24
A 88	2240	0,25
A 89	2267	0,25
A 90	2286	0,25
A 91	2311	0,25
A 92	2337	0,26
A 93	2360	0,26
A 94	2388	0,26
A 95	2413	0,27
A 96	2438	0,27
A 97	2464	0,27
A 97 1/2	2476	0,27
A 98	2490	0,27
A 99	2515	0,28
A 100	2540	0,28
A 102	2591	0,28
A 103	2616	0,29
A 104	2641	0,29
A 105	2667	0,29
A 107	2718	0,30
A 108	2743	0,30
A 109	2768	0,30
A 110	2800	0,30
A 112	2845	0,31
A 113	2870	0,31
A 115	2920	0,32
A 116	2946	0,32
A 118	3000	0,33

CINGHIE TRAPEZOIDALI A SEZIONE CLASSICA

CLASSICAL V-BELTS

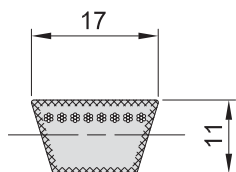

B

codice	sviluppo interno mm	Kg.
B 22 1/2	570	0,12
B 23	587	0,12
B 24	612	0,12
B 24 1/2	625	0,13
B 25	637	0,13
B 26	660	0,13
B 27	686	0,14
B 28	710	0,14
B 29	737	0,15
B 29 1/2	750	0,15
B 30	762	0,15
B 30 1/2	775	0,16
B 31	787	0,16
B 32	800	0,16
B 32 1/4	822	0,16
B 32 1/2	829	0,16
B 33	838	0,17
B 33 1/2	850	0,17
B 34	863	0,17
B 34 1/2	875	0,17
B 34 3/4	880	0,17
B 35	889	0,18
B 35 1/2	900	0,18
B 35 3/4	907	0,18
B 36	917	0,18
B 36 3/4	937	0,19
B 37	942	0,19
B 38	965	0,19
B 38 1/2	978	0,19
B 39	990	0,19
B 39 1/2	1002	0,20
B 40	1016	0,20
B 40 1/2	1028	0,20
B 41	1040	0,20
B 42	1067	0,21
B 42 1/2	1079	0,21
B 43	1090	0,21
B 44	1120	0,22
B 44 1/4	1127	0,22
B 45	1142	0,22
B 46	1168	0,23
B 46 1/2	1180	0,23
B 46 3/4	1187	0,23
B 47	1194	0,23
B 47 1/4	1200	0,23
B 47 1/2	1207	0,24
B 48	1220	0,24
B 49	1250	0,24
B 50	1275	0,25
B 51	1300	0,25
B 52	1320	0,26
B 53	1350	0,26
B 53 1/2	1360	0,26
B 54	1372	0,27
B 55	1400	0,27
B 55 1/2	1412	0,27
B 56	1422	0,27
B 57	1450	0,28
B 58	1473	0,28
B 59	1500	0,29
B 60	1525	0,29



B

codice	sviluppo interno mm	Kg.
B 61	1550	0,30
B 62	1575	0,30
B 63	1600	0,31
B 64	1625	0,31
B 64 1/2	1637	0,31
B 65	1650	0,32
B 66	1676	0,32
B 66 1/4	1682	0,32
B 66 1/2	1692	0,32
B 67	1700	0,33
B 67 1/4	1712	0,33
B 68	1725	0,33
B 69	1750	0,34
B 69 1/2	1762	0,34
B 70	1775	0,34
B 71	1800	0,34
B 72	1829	0,35
B 73	1850	0,35
B 74	1880	0,36
B 75	1905	0,36
B 76	1930	0,37
B 77	1956	0,37
B 78	1981	0,38
B 79	2000	0,38
B 80	2032	0,38
B 81	2060	0,39
B 82	2083	0,40
B 83	2108	0,40
B 84	2134	0,40
B 85	2160	0,41
B 86	2187	0,42
B 87	2215	0,42
B 88	2240	0,43
B 89	2261	0,43
B 90	2286	0,43
B 91	2312	0,44
B 92	2337	0,44
B 93	2360	0,45
B 94	2388	0,45
B 95	2413	0,46
B 96	2438	0,46
B 97	2465	0,47
B 97 1/2	2477	0,47
B 98	2500	0,47
B 99	2515	0,48
B 100	2540	0,48
B 101	2566	0,49
B 102	2600	0,49
B 103	2616	0,50
B 104	2641	0,50
B 105	2667	0,51
B 106	2700	0,51
B 107	2718	0,51
B 108	2750	0,52
B 110	2800	0,53
B 112	2845	0,54
B 112 1/2	2857	0,54
B 113	2870	0,54
B 114	2900	0,55
B 115	2921	0,55
B 116	2950	0,56

CINGHIE TRAPEZOIDALI A SEZIONE CLASSICA

CLASSICAL V-BELTS

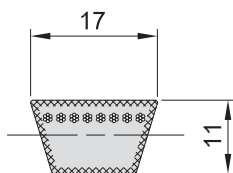

B

codice	sviluppo interno mm	Kg.
B 118	3000	0,57
B 120	3048	0,58
B 122	3100	0,59
B 124	3150	0,60
B 126	3200	0,60
B 127	3227	0,61
B 128	3250	0,61
B 130	3302	0,62
B 131	3327	0,63
B 132	3350	0,63
B 133	3378	0,64
B 134	3407	0,64
B 135	3429	0,65
B 136	3450	0,65
B 138	3505	0,66
B 140	3550	0,67
B 142	3607	0,68
B 144	3658	0,69
B 146	3709	0,70
B 147	3737	0,70
B 148	3750	0,71
B 151	3850	0,72
B 152	3861	0,73
B 154	3912	0,74
B 155	3950	0,74
B 157	3987	0,75
B 158	4000	0,75
B 161	4087	0,77
B 162	4115	0,77
B 163	4142	0,78
B 165	4200	0,79
B 167	4250	0,80
B 168	4267	0,80
B 169	4292	0,81
B 173	4394	0,83
B 175	4450	0,84
B 177	4500	0,85
B 180	4572	0,86
B 186	4727	0,89
B 187	4750	0,89
B 188	4777	0,90
B 190	4826	0,91
B 192	4877	0,91
B 195	4953	0,93
B 197	5000	0,94
B 200	5080	0,95
B 201	5105	0,96
B 204	5182	0,97
B 208	5285	0,99
B 210	5334	1,00
B 212	5385	1,01
B 214	5436	1,02
B 217	5507	1,03
B 220	5588	1,05
B 221	5615	1,05
B 223	5664	1,06
B 224	5690	1,07
B 225	5715	1,07
B 228	5792	1,08
B 229	5816	1,09
B 232	5893	1,10



B

codice	sviluppo interno mm	Kg.
B 237	6020	1,13
B 240	6096	1,14
B 248	6300	1,18
B 249	6325	1,18
B 253	6426	1,20
B 255	6477	1,21
B 259	6579	1,23
B 265	6730	1,26
B 270	6858	1,28
B 276	7010	1,31
B 280	7112	1,33
B 285	7240	1,35
B 300	7620	1,42
B 315	8000	1,49
B 330	8382	1,56
B 345	8763	1,63
B 360	9145	1,70
B 361	9170	1,71
B 364	9246	1,72
B 366	9296	1,73
B 374	9500	1,77
B 394	10008	1,86
B 428 1/2	10885	2,03
B 433	11000	2,05
B 449	11400	2,12
B 472	11990	2,23
B 473	12014	2,24
B 488	12400	2,31
B 510	12955	2,41
B 512	13000	2,42
B 551	13995	2,60
B 553	14046	2,61
B 583	14808	2,75

CINGHIE TRAPEZOIDALI A SEZIONE CLASSICA

CLASSICAL V-BELTS

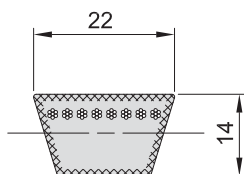

C



C

codice	sviluppo interno mm	Kg.
C 39	990	0,32
C 39 3/4	1013	0,33
C 41	1041	0,34
C 42	1067	0,34
C 43	1090	0,35
C 44	1120	0,36
C 45	1143	0,37
C 46	1168	0,37
C 47	1194	0,38
C 48	1220	0,39
C 49	1250	0,40
C 51	1295	0,41
C 52	1320	0,42
C 53	1350	0,43
C 54	1370	0,43
C 55	1400	0,44
C 56	1425	0,45
C 57	1448	0,46
C 58	1473	0,46
C 58 1/2	1486	0,47
C 59	1500	0,47
C 60	1524	0,48
C 61	1550	0,49
C 62	1574	0,50
C 62 1/4	1583	0,50
C 63	1600	0,50
C 65	1650	0,52
C 66	1676	0,52
C 67	1702	0,53
C 68	1727	0,54
C 69	1753	0,55
C 70	1778	0,55
C 71	1804	0,56
C 71 1/2	1816	0,57
C 72	1829	0,57
C 73	1854	0,58
C 74	1880	0,59
C 75	1905	0,59
C 76	1925	0,60
C 78	1981	0,62
C 79	2006	0,62
C 80	2032	0,63
C 81	2057	0,64
C 82	2082	0,65
C 83	2108	0,65
C 84	2134	0,66
C 85	2159	0,67
C 86	2184	0,67
C 87	2208	0,68
C 88	2235	0,69
C 89	2260	0,70
C 90	2286	0,71
C 91	2311	0,71
C 92	2336	0,72
C 93	2360	0,73
C 94	2388	0,74
C 95	2413	0,74
C 96	2438	0,75
C 97	2462	0,76
C 97 1/2	2475	0,76
C 98	2489	0,77

codice	sviluppo interno mm	Kg.
C 99	2525	0,78
C 100	2540	0,78
C 101	2560	0,79
C 102	2591	0,79
C 104	2642	0,81
C 105	2667	0,82
C 106	2692	0,83
C 108	2750	0,84
C 110	2800	0,86
C 111	2818	0,86
C 112	2845	0,87
C 112 1/2	2857	0,88
C 114	2896	0,88
C 115	2921	0,89
C 116	2950	0,90
C 117	2971	0,91
C 118	3000	0,92
C 120	3048	0,93
C 122	3100	0,95
C 124	3150	0,96
C 126	3200	0,98
C 128	3250	0,99
C 130	3302	1,00
C 132	3350	1,02
C 134	3404	1,04
C 136	3456	1,05
C 138	3505	1,07
C 140	3550	1,08
C 142	3607	1,10
C 144	3658	1,11
C 145	3682	1,12
C 146	3708	1,13
C 147	3733	1,14
C 148	3750	1,14
C 150	3810	1,16
C 152	3860	1,17
C 153	3902	1,18
C 154	3912	1,19
C 158	4000	1,21
C 160	4064	1,23
C 162	4115	1,25
C 165	4193	1,27
C 166	4216	1,28
C 168	4267	1,29
C 170	4318	1,31
C 173	4394	1,33
C 175	4445	1,35
C 177	4500	1,36
C 178	4522	1,37
C 180	4572	1,38
C 185	4699	1,42
C 187	4750	1,44
C 189	4800	1,45
C 193	4900	1,48
C 195	4953	1,50
C 197	5004	1,51
C 200	5080	1,54
C 204	5182	1,50
C 208	5285	1,60
C 210	5334	1,61
C 212	5384	1,63

CINGHIE TRAPEZOIDALI A SEZIONE "STRETTA" NARROW V-BELTS

Introduzione - Introduction

Le cinghie trapezoidali a sezione stretta rappresentano un'evoluzione delle cinghie a sezione classica. Sono adatte a trasmissioni ad alte velocità e rispetto alle cinghie con sezioni classiche, garantiscono una trasmissione più compatta con una riduzione, anche del 50%, delle gole e cinghie impiegate.

The narrow section V-belts represent an evolution of the belts with classical section. They are suitable for high-speed transmission and, with respect to the classical section, they provide a more compact transmission with a reduction of 50% of gorges and belts used.

Descrizione e caratteristiche - Description and features

- Le cinghie a sezione stretta sono costruite secondo le norme ISO 4184 / DIN 7753
- Armatura di cavi in poliestere ad allungamento ridotto
- Rivestimento esterno molto robusto a fianchi ricoperti
- Resistenza agli oli minerali ed ai climi tropicali
- Antistatiche (conforme alla norma ISO 1813)
- Temperatura d'esercizio da -20° a $+80^{\circ}$
- The Narrow section belts are made according to ISO 4184 / DIN 7753
- Reinforced polyester cables with reduced elongation
- Outer covering very robust with side covered
- Resistance to mineral oils and tropical climates
- Antistatic (according to ISO 1813)
- Operating temperature from -20° to $+80^{\circ}$

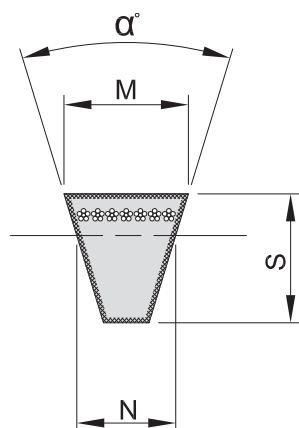
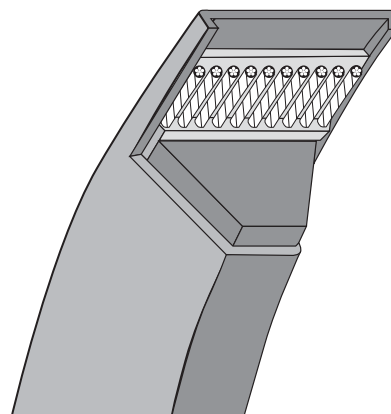

Dimensioni cinghia Dimension of V-belts				
codice	α gradi	M mm	S mm	N mm
SPZ (mm)	38°	9,7	8	8,5
SPA (mm)	38°	12,7	10	11,0
SPB (mm)	38°	16,3	13	14,0
SPC (mm)	38°	22,0	18	19,0

CINGHIE TRAPEZOIDALI A SEZIONE "STRETTA" NARROW V-BELTS

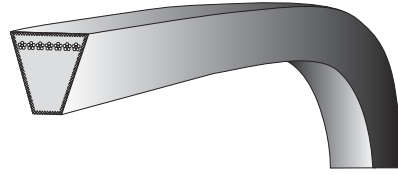
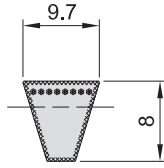

SPZ

codice	sviluppo mm	Kg.
SPZ 512	512	0,03
SPZ 562	562	0,04
SPZ 587	587	0,04
SPZ 607	607	0,04
SPZ 612	612	0,04
SPZ 630	630	0,04
SPZ 637	637	0,04
SPZ 662	662	0,04
SPZ 670	670	0,04
SPZ 687	687	0,05
SPZ 710	710	0,05
SPZ 722	722	0,05
SPZ 737	737	0,05
SPZ 750	750	0,05
SPZ 762	762	0,05
SPZ 772	772	0,05
SPZ 787	787	0,05
SPZ 800	800	0,05
SPZ 812	812	0,05
SPZ 825	825	0,05
SPZ 837	837	0,06
SPZ 850	850	0,06
SPZ 862	862	0,06
SPZ 875	875	0,06
SPZ 887	887	0,06
SPZ 900	900	0,06
SPZ 912	912	0,06
SPZ 922	922	0,06
SPZ 937	937	0,06
SPZ 950	950	0,06
SPZ 957	957	0,06
SPZ 962	962	0,06
SPZ 987	987	0,07
SPZ 1000	1000	0,07
SPZ 1012	1012	0,07
SPZ 1024	1024	0,07
SPZ 1037	1037	0,07
SPZ 1047	1047	0,07
SPZ 1060	1060	0,07
SPZ 1077	1077	0,07
SPZ 1087	1087	0,07
SPZ 1112	1112	0,07
SPZ 1120	1120	0,07
SPZ 1137	1137	0,08
SPZ 1147	1147	0,08
SPZ 1150	1150	0,08
SPZ 1162	1162	0,08
SPZ 1180	1180	0,08
SPZ 1187	1187	0,08
SPZ 1202	1202	0,08
SPZ 1212	1212	0,08
SPZ 1237	1237	0,08
SPZ 1250	1250	0,08
SPZ 1262	1262	0,08
SPZ 1270	1270	0,08
SPZ 1280	1280	0,08
SPZ 1287	1287	0,09
SPZ 1312	1312	0,09
SPZ 1314	1314	0,09
SPZ 1320	1320	0,09
SPZ 1337	1337	0,09

SPZ

codice	sviluppo mm	Kg.
SPZ 1347	1347	0,09
SPZ 1362	1362	0,09
SPZ 1387	1387	0,09
SPZ 1400	1400	0,09
SPZ 1412	1412	0,09
SPZ 1437	1437	0,09
SPZ 1462	1462	0,10
SPZ 1487	1487	0,10
SPZ 1500	1500	0,10
SPZ 1512	1512	0,10
SPZ 1537	1537	0,10
SPZ 1562	1562	0,10
SPZ 1587	1587	0,10
SPZ 1600	1600	0,11
SPZ 1612	1612	0,11
SPZ 1637	1637	0,11
SPZ 1650	1650	0,11
SPZ 1662	1662	0,11
SPZ 1687	1687	0,11
SPZ 1700	1700	0,11
SPZ 1737	1737	0,11
SPZ 1750	1750	0,12
SPZ 1762	1762	0,12
SPZ 1787	1787	0,12
SPZ 1800	1800	0,12
SPZ 1812	1812	0,12
SPZ 1837	1837	0,12
SPZ 1850	1850	0,12
SPZ 1862	1862	0,12
SPZ 1880	1880	0,12
SPZ 1887	1887	0,12
SPZ 1900	1900	0,12
SPZ 1937	1937	0,13
SPZ 1950	1950	0,13
SPZ 1962	1962	0,13
SPZ 1987	1987	0,13
SPZ 2000	2000	0,13
SPZ 2019	2019	0,13
SPZ 2037	2037	0,13
SPZ 2062	2062	0,14
SPZ 2087	2087	0,14
SPZ 2120	2120	0,14
SPZ 2137	2137	0,14
SPZ 2187	2187	0,14
SPZ 2240	2240	0,15
SPZ 2262	2262	0,15
SPZ 2287	2287	0,15
SPZ 2360	2360	0,15
SPZ 2437	2437	0,16
SPZ 2487	2487	0,16
SPZ 2500	2500	0,16
SPZ 2580	2580	0,17
SPZ 2650	2650	0,17
SPZ 2687	2687	0,18
SPZ 2720	2720	0,18
SPZ 2800	2800	0,18
SPZ 3000	3000	0,20
SPZ 3150	3150	0,21
SPZ 3350	3350	0,22
SPZ 3550	3550	0,23

CINGHIE TRAPEZOIDALI A SEZIONE "STRETTA" NARROW V-BELTS

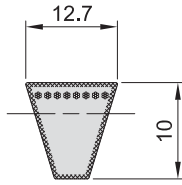

SPA

codice	sviluppo mm	Kg.
SPA 647	647	0,08
SPA 707	707	0,08
SPA 732	732	0,09
SPA 757	757	0,09
SPA 762	762	0,09
SPA 782	782	0,09
SPA 800	800	0,09
SPA 807	807	0,09
SPA 832	832	0,10
SPA 850	850	0,10
SPA 857	857	0,10
SPA 882	882	0,10
SPA 900	900	0,11
SPA 907	907	0,11
SPA 925	925	0,11
SPA 932	932	0,11
SPA 950	950	0,11
SPA 957	957	0,11
SPA 982	982	0,11
SPA 1000	1000	0,12
SPA 1007	1007	0,12
SPA 1032	1032	0,12
SPA 1060	1060	0,12
SPA 1082	1082	0,13
SPA 1107	1107	0,13
SPA 1120	1120	0,13
SPA 1132	1132	0,13
SPA 1157	1157	0,14
SPA 1180	1180	0,14
SPA 1207	1207	0,14
SPA 1232	1232	0,14
SPA 1250	1250	0,15
SPA 1257	1257	0,15
SPA 1272	1272	0,15
SPA 1282	1282	0,15
SPA 1307	1307	0,15
SPA 1320	1320	0,15
SPA 1332	1332	0,16
SPA 1357	1357	0,16
SPA 1382	1382	0,16
SPA 1400	1400	0,16
SPA 1407	1407	0,16
SPA 1425	1425	0,17
SPA 1432	1432	0,17
SPA 1457	1457	0,17
SPA 1482	1482	0,17
SPA 1500	1500	0,17
SPA 1507	1507	0,18
SPA 1532	1532	0,18
SPA 1557	1557	0,18
SPA 1582	1582	0,18
SPA 1600	1600	0,19
SPA 1607	1607	0,19
SPA 1632	1632	0,19
SPA 1650	1650	0,19
SPA 1657	1657	0,19
SPA 1682	1682	0,20
SPA 1700	1700	0,20
SPA 1707	1707	0,20
SPA 1732	1732	0,20
SPA 1757	1757	0,20
SPA 1782	1782	0,21
SPA 1800	1800	0,21
SPA 1807	1807	0,21
SPA 1832	1832	0,21

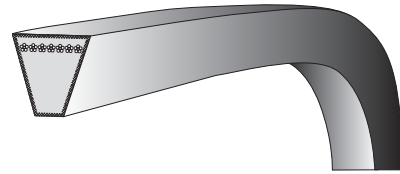

SPA

codice	sviluppo mm	Kg.
SPA 1857	1857	0,22
SPA 1882	1882	0,22
SPA 1900	1900	0,22
SPA 1907	1907	0,22
SPA 1925	1925	0,22
SPA 1932	1932	0,22
SPA 1957	1957	0,23
SPA 1982	1982	0,23
SPA 2000	2000	0,23
SPA 2032	2032	0,24
SPA 2057	2057	0,24
SPA 2067	2067	0,24
SPA 2082	2082	0,24
SPA 2120	2120	0,25
SPA 2132	2132	0,25
SPA 2182	2182	0,25
SPA 2207	2207	0,26
SPA 2232	2232	0,26
SPA 2240	2240	0,26
SPA 2282	2282	0,26
SPA 2300	2300	0,27
SPA 2307	2307	0,27
SPA 2332	2332	0,27
SPA 2360	2360	0,27
SPA 2382	2382	0,28
SPA 2432	2432	0,28
SPA 2482	2482	0,29
SPA 2500	2500	0,29
SPA 2532	2532	0,29
SPA 2580	2580	0,30
SPA 2582	2582	0,30
SPA 2607	2607	0,30
SPA 2632	2632	0,30
SPA 2650	2650	0,31
SPA 2682	2682	0,31
SPA 2720	2720	0,31
SPA 2725	2725	0,32
SPA 2732	2732	0,32
SPA 2782	2782	0,32
SPA 2800	2800	0,32
SPA 2832	2832	0,33
SPA 2847	2847	0,33
SPA 2882	2882	0,33
SPA 2932	2932	0,34
SPA 2982	2982	0,34
SPA 3000	3000	0,35
SPA 3032	3032	0,35
SPA 3082	3082	0,36
SPA 3150	3150	0,36
SPA 3182	3182	0,37
SPA 3250	3250	0,38
SPA 3282	3282	0,38
SPA 3350	3350	0,39
SPA 3382	3382	0,39
SPA 3400	3400	0,39
SPA 3450	3450	0,40
SPA 3482	3482	0,40
SPA 3550	3550	0,41
SPA 3650	3650	0,42
SPA 3750	3750	0,43
SPA 4000	4000	0,46
SPA 4250	4250	0,49
SPA 4500	4500	0,52

CINGHIE TRAPEZOIDALI A SEZIONE "STRETTA" DENTELLATE

RAW EDGE V-BELTS

Introduzione - Introduction

Le cinghie trapezoidali a sezione stretta, dentellate a fianchi tagliati, sono il risultato dell'applicazione di nuove tecnologie costruttive che garantiscono una qualità elevata ed una maggior durata. Rispetto alle cinghie a sezione stretta e fianchi ricoperti, permettono di ridurre di un 30% il numero delle gole e delle cinghie impiegate. Grazie alla dentellatura, questa cinghia può avvolgersi su diametri inferiori rispetto a quelli con sezione classica, permettendo quindi di sviluppare trasmissioni più compatte e raggiungere rapporti di trasmissione più elevate.

The narrow section V-belts, toothed side cut, are the result of new construction technologies that ensure high quality and longer life. Compared to the belts with narrow section and sides covered, they allow to reduce by 30% the number of gorges and belts used. Thanks to the dentation, this belt can wrap on smaller diameters than those with classical section, allowing to developing more compact transmissions and to reach higher gear ratios.

Descrizione e caratteristiche - Description and features

- Le cinghie a sezione stretta sono costruite secondo le norme ISO 4184 / DIN 7753
- Armatura di cavi in poliestere rinforzato ad allungamento ridotto
- Fianchi rettificati per una maggior precisione di funzionamento
- Resistenza agli oli minerali ed ai climi tropicali
- Antistatiche (conforme alla norma ISO 1813)
- Temperatura d'esercizio da -25° a $+80^{\circ}$
- The Narrow section belts are made according to ISO 4184 / DIN 7753
- Reinforced polyester cables with reduced elongation
- Hips grinded for greater accuracy of operation
- Resistance to mineral oils and tropical climates
- Antistatic (according to ISO 1813)
- Operating temperature from -25° to $+80^{\circ}$

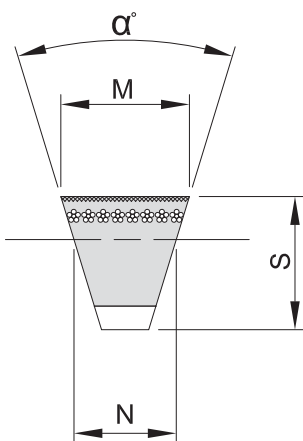
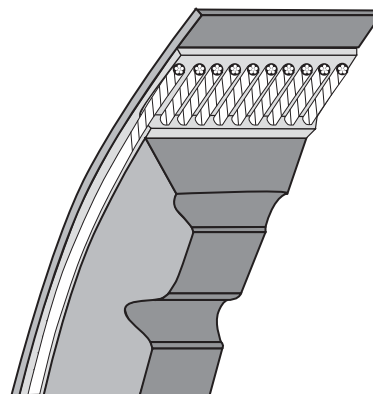

Dimensioni cinghia Dimension of V-belts				
codice	α gradi	M mm	S mm	N mm
SPZ (mm)	38°	9,7	8	8,5
SPA (mm)	38°	12,7	10	11,0
SPB (mm)	38°	16,3	13	14,0
SPC (mm)	38°	22,0	18	19,0

CINGHIE TRAPEZOIDALI A SEZIONE "STRETTA" DENTELLATE RAW EDGE V-BELTS

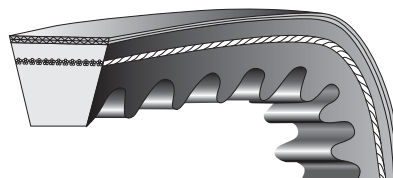
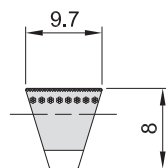

XPZ

codice	sviluppo mm	Kg.
XPZ 587	587	0,04
XPZ 607	607	0,04
XPZ 612	612	0,04
XPZ 630	630	0,04
XPZ 637	637	0,04
XPZ 662	662	0,04
XPZ 670	670	0,04
XPZ 687	687	0,04
XPZ 710	710	0,04
XPZ 722	722	0,04
XPZ 737	737	0,05
XPZ 750	750	0,05
XPZ 762	762	0,05
XPZ 775	775	0,05
XPZ 787	787	0,05
XPZ 800	800	0,05
XPZ 812	812	0,05
XPZ 837	837	0,05
XPZ 850	850	0,05
XPZ 862	862	0,05
XPZ 875	875	0,05
XPZ 887	887	0,05
XPZ 900	900	0,06
XPZ 912	912	0,06
XPZ 925	925	0,06
XPZ 937	937	0,06
XPZ 950	950	0,06
XPZ 960	960	0,06
XPZ 962	962	0,06
XPZ 987	987	0,06
XPZ 1000	1000	0,06
XPZ 1012	1012	0,06
XPZ 1024	1024	0,06
XPZ 1037	1037	0,06
XPZ 1047	1047	0,06
XPZ 1060	1060	0,06
XPZ 1062	1062	0,07
XPZ 1077	1077	0,07
XPZ 1087	1087	0,07
XPZ 1112	1112	0,07
XPZ 1120	1120	0,07
XPZ 1137	1137	0,07
XPZ 1140	1140	0,07
XPZ 1147	1147	0,07
XPZ 1162	1162	0,07
XPZ 1180	1180	0,07
XPZ 1187	1187	0,07
XPZ 1202	1202	0,07
XPZ 1212	1212	0,07
XPZ 1237	1237	0,08
XPZ 1250	1250	0,08
XPZ 1262	1262	0,08
XPZ 1270	1270	0,08
XPZ 1287	1287	0,08
XPZ 1312	1312	0,08
XPZ 1320	1320	0,08
XPZ 1337	1337	0,08
XPZ 1340	1340	0,08
XPZ 1362	1362	0,08
XPZ 1387	1387	0,08
XPZ 1400	1400	0,09

XPZ

codice	sviluppo mm	Kg.
XPZ 1412	1412	0,09
XPZ 1420	1420	0,09
XPZ 1437	1437	0,09
XPZ 1462	1462	0,09
XPZ 1487	1487	0,09
XPZ 1500	1500	0,09
XPZ 1512	1512	0,09
XPZ 1537	1537	0,09
XPZ 1562	1562	0,10
XPZ 1587	1587	0,10
XPZ 1600	1600	0,10
XPZ 1612	1612	0,10
XPZ 1637	1637	0,10
XPZ 1662	1662	0,10
XPZ 1687	1687	0,10
XPZ 1700	1700	0,10
XPZ 1737	1737	0,11
XPZ 1762	1762	0,11
XPZ 1787	1787	0,11
XPZ 1800	1800	0,11
XPZ 1812	1812	0,11
XPZ 1850	1850	0,11
XPZ 1862	1862	0,11
XPZ 1887	1887	0,11
XPZ 1900	1900	0,12
XPZ 1937	1937	0,12
XPZ 1962	1962	0,12
XPZ 1987	1987	0,12
XPZ 2000	2000	0,12
XPZ 2019	2019	0,12
XPZ 2037	2037	0,12
XPZ 2120	2120	0,13
XPZ 2187	2187	0,13
XPZ 2240	2240	0,14
XPZ 2280	2280	0,14
XPZ 2360	2360	0,14
XPZ 2500	2500	0,15

CINGHIE TRAPEZOIDALI A SEZIONE "STRETTA" DENTELLATE RAW EDGE V-BELTS

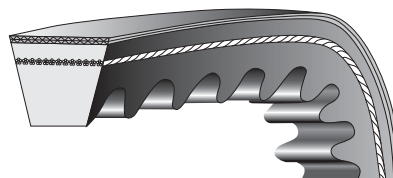
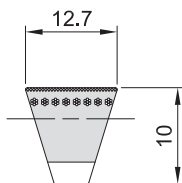

XPA

codice	sviluppo mm	Kg.
XPA 612	612	0,07
XPA 710	710	0,08
XPA 732	732	0,08
XPA 757	757	0,09
XPA 782	782	0,09
XPA 800	800	0,09
XPA 807	807	0,09
XPA 812	812	0,09
XPA 832	832	0,09
XPA 850	850	0,10
XPA 857	857	0,10
XPA 875	875	0,10
XPA 882	882	0,10
XPA 900	900	0,10
XPA 907	907	0,10
XPA 925	925	0,10
XPA 932	932	0,10
XPA 950	950	0,11
XPA 957	957	0,11
XPA 982	982	0,11
XPA 1000	1000	0,11
XPA 1007	1007	0,11
XPA 1012	1012	0,11
XPA 1032	1032	0,12
XPA 1048	1048	0,12
XPA 1060	1060	0,12
XPA 1082	1082	0,12
XPA 1107	1107	0,12
XPA 1120	1120	0,13
XPA 1132	1132	0,13
XPA 1150	1150	0,13
XPA 1157	1157	0,13
XPA 1180	1180	0,13
XPA 1207	1207	0,13
XPA 1232	1232	0,14
XPA 1250	1250	0,14
XPA 1257	1257	0,14
XPA 1282	1282	0,14
XPA 1307	1307	0,15
XPA 1320	1320	0,15
XPA 1332	1332	0,15
XPA 1357	1357	0,15
XPA 1382	1382	0,15
XPA 1400	1400	0,16
XPA 1407	1407	0,16
XPA 1432	1432	0,16
XPA 1450	1450	0,16
XPA 1457	1457	0,16
XPA 1482	1482	0,16
XPA 1500	1500	0,17
XPA 1507	1507	0,17
XPA 1532	1532	0,17
XPA 1550	1550	0,17
XPA 1557	1557	0,17
XPA 1582	1582	0,18
XPA 1600	1600	0,18
XPA 1607	1607	0,18
XPA 1632	1632	0,18
XPA 1682	1682	0,19
XPA 1700	1700	0,19
XPA 1707	1707	0,19
XPA 1732	1732	0,19
XPA 1757	1757	0,20
XPA 1782	1782	0,20
XPA 1800	1800	0,20

XPA

codice	sviluppo mm	Kg.
XPA 1807	1807	0,20
XPA 1832	1832	0,20
XPA 1857	1857	0,21
XPA 1882	1882	0,21
XPA 1900	1900	0,21
XPA 1907	1907	0,21
XPA 1932	1932	0,21
XPA 1957	1957	0,22
XPA 1982	1982	0,22
XPA 2000	2000	0,22
XPA 2032	2032	0,23
XPA 2057	2057	0,23
XPA 2082	2082	0,23
XPA 2120	2120	0,24
XPA 2240	2240	0,25
XPA 2282	2282	0,25
XPA 2293	2293	0,25
XPA 2300	2300	0,25
XPA 2307	2307	0,26
XPA 2360	2360	0,26
XPA 2432	2432	0,27
XPA 2482	2482	0,27
XPA 2500	2500	0,28
XPA 2580	2580	0,29
XPA 2650	2650	0,29
XPA 2682	2682	0,30
XPA 2720	2720	0,30
XPA 2800	2800	0,31
XPA 3000	3000	0,33
XPA 3150	3150	0,35
XPA 3350	3350	0,37
XPA 3550	3550	0,39
XPA 3750	3750	0,41
XPA 4000	4000	0,44
XPA 4250	4250	0,47
XPA 4500	4500	0,50

CINGHIE TRAPEZOIDALI A SEZIONE "STRETTA" DENTELLATE RAW EDGE V-BELTS

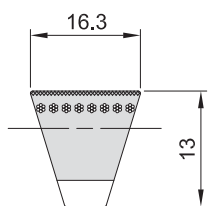

XPB

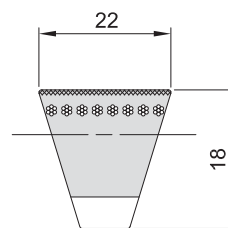

XPC

codice	sviluppo mm	Kg.
XPB 1250	1250	0,23
XPB 1260	1260	0,24
XPB 1270	1270	0,24
XPB 1320	1320	0,25
XPB 1340	1340	0,25
XPB 1350	1350	0,25
XPB 1360	1360	0,25
XPB 1400	1400	0,26
XPB 1450	1450	0,27
XPB 1470	1470	0,27
XPB 1500	1500	0,28
XPB 1514	1514	0,28
XPB 1550	1550	0,29
XPB 1600	1600	0,30
XPB 1650	1650	0,31
XPB 1690	1690	0,32
XPB 1700	1700	0,32
XPB 1750	1750	0,33
XPB 1800	1800	0,34
XPB 1900	1900	0,35
XPB 2000	2000	0,37
XPB 2060	2060	0,38
XPB 2120	2120	0,40
XPB 2240	2240	0,42
XPB 2280	2280	0,42
XPB 2360	2360	0,44
XPB 2400	2400	0,45
XPB 2500	2500	0,47
XPB 2530	2530	0,47
XPB 2580	2580	0,48
XPB 2650	2650	0,49
XPB 2680	2680	0,50
XPB 2710	2710	0,50
XPB 2730	2730	0,51
XPB 2800	2800	0,52
XPB 2840	2840	0,53
XPB 2900	2900	0,54
XPB 3000	3000	0,56
XPB 3150	3150	0,59
XPB 3350	3350	0,62
XPB 3550	3550	0,66
XPB 3750	3750	0,70
XPB 3800	3800	0,71
XPB 3825	3825	0,71
XPB 4050	4050	0,75
XPB 4250	4250	0,79
XPB 4300	4300	0,80
XPB 4550	4550	0,84

codice	sviluppo mm	Kg.
XPC 2000	2000	0,66
XPC 2120	2120	0,70
XPC 2240	2240	0,74
XPC 2360	2360	0,78
XPC 2500	2500	0,83
XPC 2650	2650	0,88
XPC 2800	2800	0,93
XPC 3000	3000	0,99
XPC 3150	3150	1,04
XPC 3350	3350	1,11
XPC 3550	3550	1,18
XPC 3750	3750	1,24
XPC 4000	4000	1,32
XPC 4250	4250	1,41
XPC 4500	4500	1,49
XPC 5000	5000	1,65

BUSSOLE CONICHE DI SERRAGGIO - DATI TECNICI

TAPER BUSHES - TECHNICAL DATA

Caratteristiche / Characteristics

Le bussole coniche permettono di allineare o bloccare pulegge, pignoni dentati o giunti all'albero di trasmissione in modo rapido e senza l'utilizzo di attrezzature. Le bussole sono complete di alesaggio e cava per chiave.

La bussola conica elastica permette un recupero delle tolleranze.

E' possibile riutilizzare una bussola dopo un rimpiazzo.

The taper bushes allows to align or to lock pulleys, sprockets or toothed couplings to a transmission shaft, quickly and without the use of equipment.

The taper bushes is equipped of bore and keyway.

The taper bushes allows an elastic recovery of tolerances and can be re-used after a replacement.



Montaggio / Assembly

Assicurarsi che le superfici coniche siano pulite, prive di olii o polveri.

Inserire la bussola nella ruota in modo da allineare i fori.

Make sure that the tapered surfaces are clean, free of oils or powders.

Place the bushes in the wheel so as to align the holes.



Posizionare le viti nei fori filettati, senza stringerle.

Pulire l'albero e quindi montarvi ruota e bussola, ricordando che la bussola stringe prima l'albero e poi la ruota.

Place the screws into the threaded holes, loosely.

Clean the transmission shaft and then mount the wheel and the bushes, pointing out that the bushes holds the transmission shaft first and then the wheel.



Con una chiave esagonale stringere le viti gradualmente ed in modo alternato.

Verificare la chiusura delle viti dopo un breve periodo di funzionamento.

With a hex key tighten the screws gradually and alternately.

Check the closing of the screws after a short period of operation.



Smontaggio / Disassembly

Allentare tutte le viti e rimuoverne una o due in base ai fori di smontaggio.

Inserire le viti nei fori di smontaggio ed avvitarle in modo alternato fino all'allentamento della bussola e fintanto che il gruppo non sia libero sull'albero.

Rimuovere la bussola e la ruota dall'albero.

Loosen all the screws and remove one or two screws depending on the holes of the disassembly.

Insert the screws into the holes for dismantling. Tighten the screws alternately until the relaxation of the bushes. Continue until the group is not free on the transmission shaft.

Remove the bushes and the wheel from the transmission shaft.

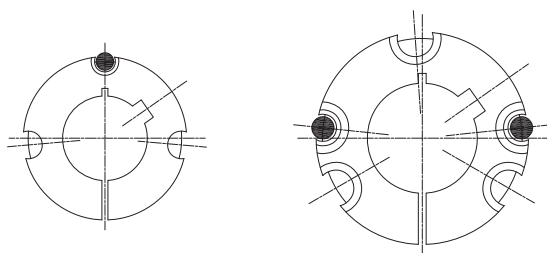

● FORI DI SMONTAGGIO

BUSSOLE CONICHE DI SERRAGGIO

TAPER BUSHES

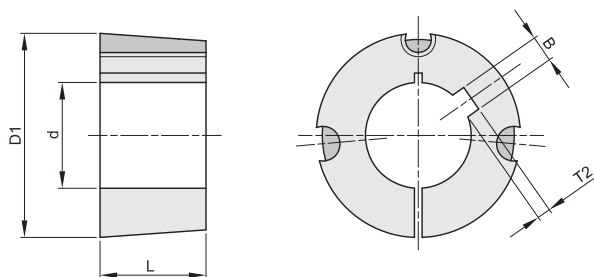

BUSSOLA 1008

Diametro maggiore (D1) = 35 Viti BSW = 1/4"
Lunghezza (L) = 22,3 Coppia di serraggio = 5,6 Nm

diam. fori d	largh.cava B	prof. cava T2	Kg.
11	4	1,8	0,13
12	4	1,8	0,12
14	5	2,3	0,12
15	5	2,3	0,11
16	5	2,3	0,11
18	6	2,8	0,10
19	6	2,8	0,10
20	6	2,8	0,09
22	6	2,8	0,08
24	8	1,3	0,07
25	8	1,3	0,07

BUSSOLA 1108

Diametro maggiore (D1) = 38 Viti BSW = 1/4"
Lunghezza (L) = 22,3 Coppia di serraggio = 5,6 Nm

diam. fori d	largh.cava B	prof. cava T2	Kg.
11	4	1,8	0,16
12	4	1,8	0,15
14	5	2,3	0,15
15	5	2,3	0,14
16	5	2,3	0,14
18	6	2,8	0,13
19	6	2,8	0,13
20	6	2,8	0,12
22	6	2,8	0,11
24	8	3,3	0,10
25	8	3,3	0,09
28	8	1,3	0,07

BUSSOLA 1210

Diametro maggiore (D1) = 47 Viti BSW = 3/8"
Lunghezza (L) = 25,4 Coppia di serraggio = 20 Nm

diam. fori d	largh.cava B	prof. cava T2	Kg.
11	4	1,8	0,28
12	4	1,8	0,28
14	5	2,3	0,27
15	5	2,3	0,26
16	5	2,3	0,26
18	6	2,8	0,25
19	6	2,8	0,24
20	6	2,8	0,24
22	6	2,8	0,22
24	8	3,3	0,21
25	8	3,3	0,21
28	8	3,3	0,18
30	8	3,3	0,17
32	10	3,3	0,15

BUSSOLA 1215

Diametro maggiore (D1) = 47 Viti BSW = 3/8"
Lunghezza (L) = 38,1 Coppia di serraggio = 20 Nm

diam. fori d	largh.cava B	prof. cava T2	Kg.
14	5	2,3	0,38
16	5	2,3	0,37
18	6	2,8	0,35
19	6	2,8	0,34
20	6	2,8	0,34
22	6	2,8	0,32
24	8	3,3	0,29
25	8	3,3	0,29
28	8	3,3	0,26
30	8	3,3	0,23
32	10	3,3	0,20

BUSSOLE CONICHE DI SERRAGGIO

TAPER BUSHES

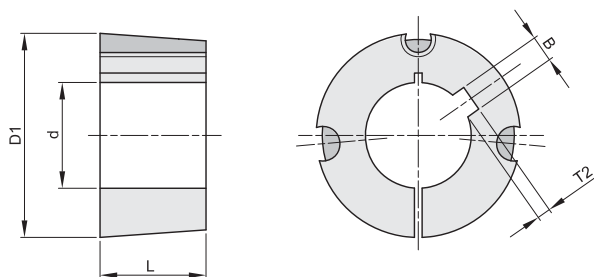

BUSSOLA 1610

Diametro maggiore (D1) = 57 Viti BSW = 3/8"
Lunghezza (L) = 25,4 Coppia di serraggio = 20Nm

diam. fori d	largh.cava B	prof. cava T2	Kg.
12	4	1,8	0,41
14	5	2,3	0,41
15	5	2,3	0,40
16	5	2,3	0,40
18	6	2,8	0,39
19	6	2,8	0,38
20	6	2,8	0,38
22	6	2,8	0,37
24	8	3,3	0,36
25	8	3,3	0,35
28	8	3,3	0,32
30	8	3,3	0,30
32	10	3,3	0,29
35	10	3,3	0,26
38	10	3,3	0,23
40	12	3,3	0,21
42	12	3,3	0,19

BUSSOLA 1615

Diametro maggiore (D1) = 57 Viti BSW = 3/8"
Lunghezza (L) = 38,1 Coppia di serraggio = 20 Nm

diam. fori d	largh.cava B	prof. cava T2	Kg.
14	5	2,3	0,58
16	5	2,3	0,58
18	6	2,8	0,56
19	6	2,8	0,55
20	6	2,8	0,55
22	6	2,8	0,53
24	8	3,3	0,50
25	8	3,3	0,49
28	8	3,3	0,47
30	8	3,3	0,45
32	10	3,3	0,41
35	10	3,3	0,38
38	10	3,3	0,32
40	12	3,3	0,29
42	12	2,2	0,26

BUSSOLA 2012

Diametro maggiore (D1) = 70 Viti BSW = 7/16"
Lunghezza (L) = 31,8 Coppia di serraggio = 31 Nm

diam. fori d	largh.cava B	prof. cava T2	Kg.
15	5	2,3	0,78
16	5	2,3	0,78
18	6	2,8	0,76
19	6	2,8	0,76
20	6	2,8	0,75
22	6	2,8	0,74
24	8	3,3	0,72
25	8	3,3	0,71
28	8	3,3	0,68
30	8	3,3	0,66
32	10	3,3	0,64
35	10	3,3	0,60
38	10	3,3	0,57
40	12	3,3	0,54
42	12	3,3	0,51
45	14	3,8	0,46
48	14	3,8	0,40
50	14	3,8	0,37

BUSSOLA 2517

Diametro maggiore (D1) = 85 Viti BSW = 1/2"
Lunghezza (L) = 44,5 Coppia di serraggio = 48 Nm

diam. fori d	largh.cava B	prof. cava T2	Kg.
19	6	2,8	1,62
20	6	2,8	1,60
22	6	2,8	1,57
24	8	3,3	1,57
25	8	3,3	1,56
28	8	3,3	1,52
30	8	3,3	1,49
32	10	3,3	1,45
35	10	3,3	1,40
38	10	3,3	1,40
40	12	3,3	1,35
42	12	3,3	1,27
45	14	3,8	1,20
48	14	3,8	1,13
50	14	3,8	1,08
55	16	4,3	0,96
60	18	4,4	0,81
65	18	4,4	0,65

BUSSOLE CONICHE DI SERRAGGIO

TAPER BUSHES

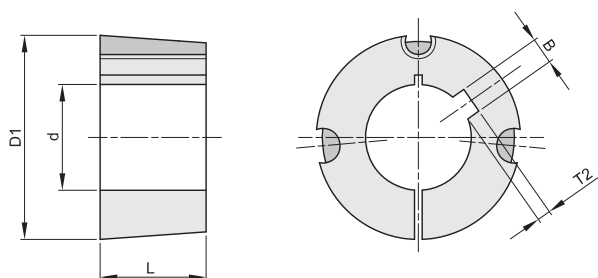

3020 - 3030

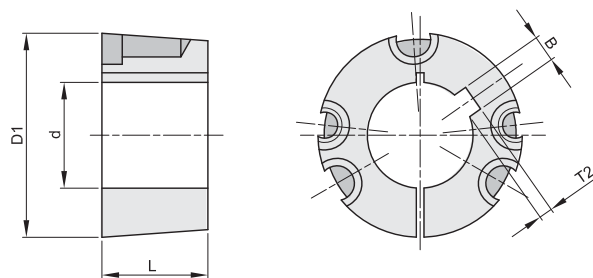

3525 - 3535

BUSSOLA 3020

Diametro maggiore (D1) = 108 Viti BSW = 5/8"
Lunghezza (L) = 50,8 Coppia di serraggio = 90Nm

diam. fori d	largh.cava B	prof. cava T2	Kg.
25	8	3,3	2,91
28	8	3,3	2,79
30	8	3,3	2,84
32	10	3,3	2,80
35	10	3,3	2,75
38	10	3,3	2,67
40	12	3,3	2,64
42	12	3,3	2,59
45	14	3,8	2,52
48	14	3,8	2,43
50	14	3,8	2,37
55	16	4,3	2,23
60	18	4,4	2,07
65	18	4,4	1,89
70	20	4,9	1,69
75	20	4,9	1,49

BUSSOLA 3030

Diametro maggiore (D1) = 108 Viti BSW = 5/8"
Lunghezza (L) = 76,2 Coppia di serraggio = 90 Nm

diam. fori d	largh.cava B	prof. cava T2	Kg.
35	10	3,3	3,95
38	10	3,3	3,86
40	12	3,3	3,82
42	12	3,3	3,69
45	14	3,8	3,55
48	14	3,8	3,45
50	14	3,8	3,42
55	16	4,3	3,18
60	18	4,4	2,95
65	18	4,4	2,68
70	20	4,9	2,38
75	20	4,9	2,03

BUSSOLA 3525

Diametro maggiore (D1) = 127 Viti BSW = 1/2"
Lunghezza (L) = 64,9 Coppia di serraggio = 112 Nm

diam. fori d	largh.cava B	prof. cava T2	Kg.
35	10	3,3	4,91
38	10	3,3	4,85
40	12	3,3	4,80
42	12	3,3	4,71
45	14	3,8	4,67
48	14	3,8	4,55
50	14	3,8	4,44
55	16	4,3	4,29
60	18	4,4	4,05
65	18	4,4	3,88
70	20	4,9	3,58
75	20	4,9	3,37
80	22	5,4	3,05
85	22	5,4	2,77
90	25	5,4	2,47

BUSSOLA 3535

Diametro maggiore (D1) = 127 Viti BSW = 1/2"
Lunghezza (L) = 88,9 Coppia di serraggio = 112 Nm

diam. fori d	largh.cava B	prof. cava T2	Kg.
35	10	3,3	6,70
38	10	3,3	6,53
40	12	3,3	6,48
42	12	3,3	6,40
45	14	3,8	6,25
48	14	3,8	6,17
50	14	3,8	6,05
55	16	4,3	5,81
60	18	4,4	5,50
65	18	4,4	5,20
70	20	4,9	4,88
75	20	4,9	4,46
80	22	5,4	4,08
85	22	5,4	3,67
90	25	5,4	3,21

BUSSOLE CONICHE DI SERRAGGIO

TAPER BUSHES

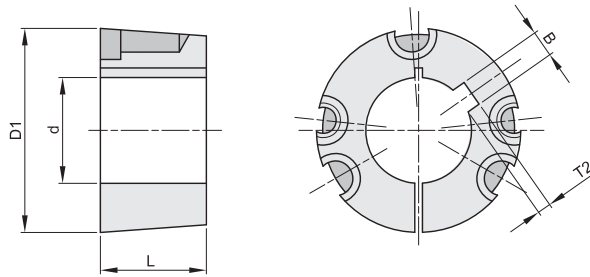

BUSSOLA 4040

Diametro maggiore (D1) = 146 Viti BSW = 5/8"
Lunghezza (L) = 101,8 Coppia di serraggio = 170Nm

diam. fori d	largh.cava B	prof. cava T2	Kg.
45	14	3,8	9,86
48	14	3,8	9,66
50	14	3,8	9,48
55	16	4,3	9,27
60	18	4,4	8,93
65	18	4,4	8,65
70	20	4,9	8,17
75	20	4,9	7,78
80	22	5,4	7,35
85	22	5,4	6,89
90	25	5,4	6,36
95	25	5,4	5,94
100	28	6,4	5,27

BUSSOLA 4545

Diametro maggiore (D1) = 162 Viti BSW = 3/4"
Lunghezza (L) = 114,3 Coppia di serraggio = 192 Nm

diam. fori d	largh.cava B	prof. cava T2	Kg.
55	16	4,3	13,15
60	18	4,4	12,76
65	18	4,4	12,38
70	20	4,9	12,02
75	20	4,9	11,57
80	22	5,4	11,05
85	22	5,4	10,46
90	25	5,4	9,99
95	25	5,4	9,42
100	28	6,4	8,63
110	28	6,4	7,37

BUSSOLA 5050

Diametro maggiore (D1) = 178 Viti BSW = 7/8"
Lunghezza (L) = 127 Coppia di serraggio = 271 Nm

diam. fori d	largh.cava B	prof. cava T2	Kg.
70	20	4,9	16,70
75	20	4,9	16,05
80	22	5,4	15,56
85	22	5,4	15,00
90	25	5,4	14,43
95	25	5,4	13,88
100	28	6,4	13,05
110	28	6,4	11,56
120	32	7,4	9,78
125	32	7,4	9,05

CALETTATORI - DATI TECNICI

LOCKING ASSEMBLIES - THECNICAL DATA

Calcolo del minimo diametro esterno mozzo (DM)
Calculation of the minimum outside diameter of hub (DM)

$$DM \geq D \cdot K$$

D = diametro esterno calettatore (mm)
outside diameter of locking assemble (mm)

K = coefficiente (vedi tabella)
coefficient (see table)

Per il calcolo del valore K, non riportato in tabella applicare la seguente formula:

To calculate the "K" value not shown in the table, use the following formula:

$$K = \sqrt{\frac{\sigma_{0,2} + (C \cdot PN)}{\sigma_{0,2} - (C \cdot PN)}} \text{ (mm)}$$

$\sigma_{0,2}$ = carico di snervamento del materiale (N/mm²)
yield strength of the material (N/mm²)

C = fattore in funzione del tipo di applicazione
factor depending on the type of the application

PN = pressione superficiale del mozzo
surface pressure of the hub



TABELLA DEL COEFFICIENTE "K" - COEFFICIENT "K" TABLE

pn N/mm ²	GG-20			GG-30 GTS-35 AlSi1MgMn			GGG-38 GS-400 St.42-3			GGG-50 GS-500 C-40			GGG-60 GS-600 C-45			GGG-70 GS-70 C-60								
	0,6	0,8	1	0,6	0,8	1	0,6	0,8	1	0,6	0,8	1	0,6	0,8	1	0,6	0,8	1	0,6	0,8	1	0,6	0,8	1
valori indicativi per il carico di snervamento $\sigma_{0,2}$ in N/mm ²																								
	150			200			250			300			350			400			450			600		
60	1,28	1,39	1,53	1,20	1,28	1,36	1,16	1,21	1,28	1,13	1,18	1,22	1,11	1,15	1,19	1,09	1,13	1,16	1,08	1,11	1,14	1,06	1,08	1,11
65	1,30	1,44	1,59	1,22	1,30	1,40	1,17	1,24	1,30	1,14	1,19	1,25	1,12	1,16	1,21	1,10	1,14	1,18	1,09	1,12	1,16	1,07	1,09	1,11
70	1,33	1,48	1,66	1,24	1,33	1,44	1,18	1,26	1,33	1,15	1,21	1,27	1,13	1,18	1,22	1,11	1,15	1,19	1,10	1,13	1,17	1,07	1,10	1,12
75	1,36	1,53	1,73	1,26	1,36	1,48	1,20	1,28	1,36	1,16	1,22	1,29	1,14	1,19	1,24	1,12	1,16	1,21	1,11	1,14	1,18	1,08	1,11	1,13
80	1,39	1,58	1,81	1,28	1,39	1,53	1,21	1,30	1,39	1,18	1,24	1,31	1,15	1,20	1,26	1,13	1,18	1,22	1,11	1,15	1,20	1,08	1,11	1,14
85	1,42	1,63	1,90	1,30	1,42	1,57	1,23	1,32	1,42	1,19	1,26	1,34	1,16	1,22	1,28	1,14	1,19	1,24	1,12	1,16	1,21	1,09	1,12	1,15
90	1,46	1,69	2,00	1,32	1,46	1,62	1,25	1,34	1,46	1,20	1,28	1,36	1,17	1,23	1,30	1,15	1,20	1,26	1,13	1,18	1,22	1,09	1,13	1,16
95	1,49	1,75	2,11	1,34	1,49	1,68	1,26	1,37	1,49	1,21	1,30	1,39	1,18	1,25	1,32	1,15	1,21	1,27	1,14	1,19	1,24	1,10	1,14	1,17
100	1,53	1,81	2,24	1,36	1,53	1,73	1,28	1,39	1,53	1,22	1,31	1,41	1,19	1,26	1,34	1,16	1,22	1,29	1,14	1,20	1,25	1,11	1,14	1,18
105	1,56	1,88	2,38	1,39	1,56	1,79	1,29	1,42	1,56	1,24	1,23	1,44	1,20	1,28	1,36	1,17	1,24	1,31	1,15	1,21	1,27	1,11	1,15	1,19
110	1,60	1,96	2,55	1,41	1,60	1,86	1,31	1,44	1,60	1,25	1,35	1,47	1,21	1,29	1,38	1,18	1,25	1,33	1,16	1,22	1,28	1,12	1,16	1,20
115	1,64	2,04	2,75	1,43	1,64	1,93	1,33	1,47	1,64	1,26	1,37	1,50	1,22	1,31	1,41	1,19	1,26	1,34	1,17	1,23	1,30	1,12	1,17	1,21
120	1,69	2,13	3,00	1,46	1,69	2,00	1,34	1,50	1,69	1,28	1,39	1,53	1,23	1,33	1,43	1,20	1,28	1,36	1,18	1,24	1,31	1,13	1,18	1,22
125	1,73	2,24	3,32	1,48	1,73	2,08	1,36	1,53	1,73	1,29	1,41	1,56	1,24	1,34	1,45	1,21	1,29	1,38	1,18	1,25	1,33	1,13	1,18	1,24
130	1,78	2,35	3,74	1,51	1,78	2,17	1,38	1,56	1,78	1,30	1,44	1,59	1,25	1,36	1,48	1,22	1,30	1,40	1,19	1,27	1,35	1,14	1,19	1,25
135	1,83	2,48	4,36	1,54	1,83	2,27	1,40	1,59	1,83	1,32	1,46	1,62	1,27	1,38	1,50	1,23	1,32	1,42	1,20	1,28	1,36	1,15	1,20	1,26
140	1,88	2,63	5,39	1,56	1,88	2,38	1,42	1,62	1,88	1,33	1,48	1,66	1,28	1,39	1,53	1,24	1,33	1,44	1,21	1,29	1,38	1,15	1,21	1,27
145	1,94	2,80	7,68	1,59	1,94	2,50	1,44	1,65	1,94	1,35	1,50	1,69	1,29	1,41	1,55	1,25	1,35	1,46	1,22	1,30	1,40	1,16	1,22	1,28
150	2,00	3,00		1,62	2,00	2,65	1,46	1,69	2,00	1,36	1,53	1,73	1,30	1,43	1,58	1,26	1,36	1,48	1,22	1,31	1,41	1,16	1,22	1,29
155	2,06	3,25		1,65	2,06	2,81	1,48	1,72	2,06	1,38	1,55	1,77	1,31	1,45	1,61	1,27	1,38	1,51	1,23	1,33	1,43	1,17	1,23	1,30
160	2,13	3,55		1,69	2,13	3,00	1,50	1,76	2,13	1,39	1,58	1,81	1,33	1,47	1,64	1,28	1,39	1,53	1,24	1,34	1,45	1,18	1,24	1,31
165	2,21	3,96		1,72	2,21	3,23	1,52	1,80	2,21	1,41	1,60	1,86	1,34	1,49	1,67	1,29	1,41	1,55	1,25	1,35	1,47	1,18	1,25	1,33
170	2,29	4,52		1,76	2,29	3,51	1,54	1,84	2,29	1,42	1,63	1,90	1,35	1,51	1,70	1,30	1,42	1,57	1,26	1,37	1,49	1,19	1,26	1,34
180	2,40	7,00		1,83	2,48	4,36	1,59	1,93	2,48	1,46	1,69	2,00	1,38	1,55	1,77	1,32	1,46	1,62	1,28	1,39	1,53	1,20	1,28	1,36
190	2,71			1,91	2,71	6,24	1,64	2,03	2,71	1,49	1,75	2,11	1,40	1,59	1,84	1,34	1,49	1,68	1,30	1,42	1,57	1,21	1,30	1,39
200	3,00			2,00	3,00		1,69	2,13	3,00	1,53	1,81	2,24	1,43	1,64	1,91	1,36	1,53	1,73	1,31	1,45	1,61	1,22	1,31	1,41
210	3,39			2,10	3,39		1,74	2,26	3,39	1,56	1,88	2,38	1,46	1,69	2,00	1,39	1,56	1,79	1,33	1,48	1,66	1,24	1,33	1,44
220	3,96			2,21	3,96		1,80	2,40	3,96	1,60	1,96	2,55	1,49	1,74	2,09	1,41	1,60	1,86	1,35	1,51	1,71	1,25	1,35	1,47
230	4,90			2,33	4,90		1,86	2,56	4,90	1,64	2,04	2,75	1,52	1,79	2,20	1,43	1,64	1,93	1,37	1,54	1,76	1,26	1,37	1,50
240	7,00			2,48	7,00		1,93	2,76	7,00	1,69	2,13	3,00	1,55	1,85	2,32	1,46	1,69	2,00	1,39	1,58	1,81	1,28	1,39	1,53
250				2,65			2,00	3,00		1,73	2,24	3,32	1,58	1,91	2,45	1,48	1,73	2,08	1,41	1,61	1,87	1,29	1,41	1,56
300				4,36			2,48	7,00		2,00	3,00		1,77	2,32	3,61	1,62	2,00	2,65	1,53	1,81	2,24	1,36	1,53	1,73

CALETTATORI AUTOCENTRANTI "BK 11"

LOCKING ASSEMBLIES SELF-CENTERING "BK 11"

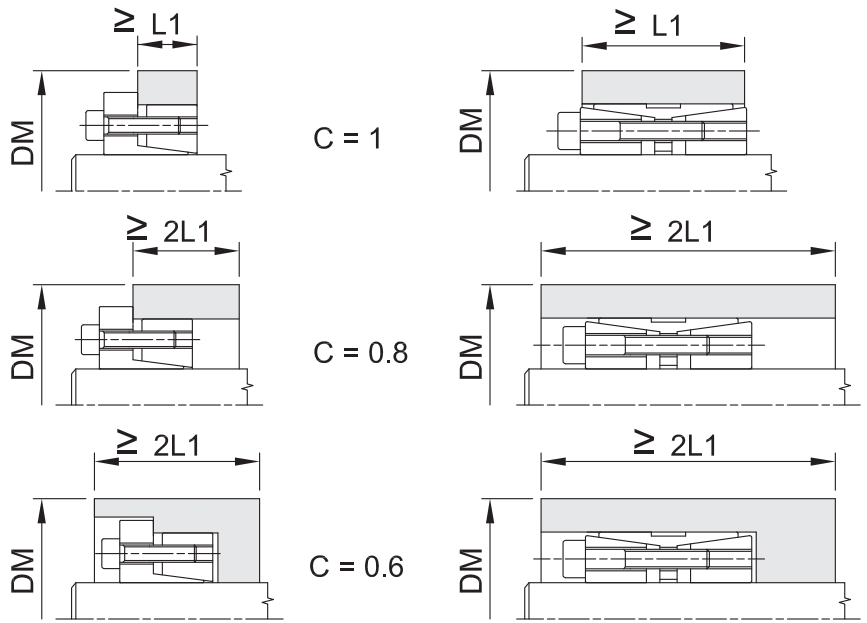
Autocentrante

Momenti torcenti molto elevati
 Tolleranze: albero h8 - mozzo H8
 Superfici di contatto con rugosità: R_t max 16 μ m
 Errore di concentricità: 0,02 \div 0,04 mm

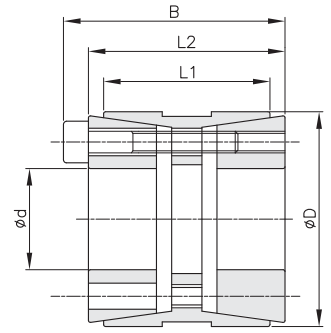
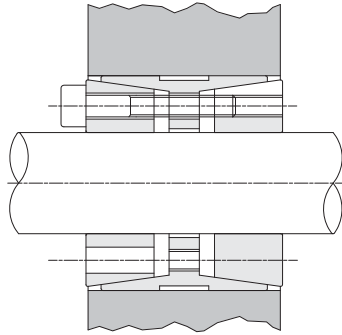

d x D mm	L1 mm	L2 mm	B mm	momento torcente Mt Nm	forza assiale F ass. KN	pressione superficiale		viti di serraggio			
						albero pw N/mm ²	mozzo pn N/mm ²	N°	DIN 912 12,9 tipo	coppia di serraggio Ms Nm	Kg.
25 x 55	32	40	46	799	64	314	107	6	M6x35	17	0,50
28 x 55	32	40	46	895	64	281	107	6	M6x35	17	0,60
30 x 55	32	40	46	959	64	262	107	6	M6x35	17	0,60
35 x 60	44	54	60	1306	75	185	83	7	M6x45	17	0,70
38 x 75	44	54	62	2567	135	308	121	7	M8x50	41	0,70
40 x 75	44	54	62	2702	135	293	121	7	M8x50	41	0,70
42 x 75	44	54	62	2837	135	279	121	7	M8x50	41	1,00
45 x 75	44	54	62	3040	135	260	121	7	M8x50	41	0,90
48 x 80	56	64	62	3707	154	216	102	8	M8x55	41	1,40
50 x 80	56	64	72	3861	154	207	102	8	M8x55	41	1,30
55 x 85	56	64	72	4779	174	212	108	9	M8x55	41	1,50
60 x 90	56	64	72	5793	193	216	113	10	M8x55	41	1,60
65 x 95	56	64	72	6276	193	199	107	10	M8x55	41	1,80
70 x 110	70	78	88	10951	313	235	120	10	M10x60	83	3,00
75 x 115	70	78	88	11733	313	220	115	10	M10x60	83	3,30
80 x 120	70	78	88	13768	344	227	121	11	M10x60	83	3,50
85 x 125	70	78	88	15959	376	233	127	12	M10x60	83	3,70
90 x 130	70	78	88	16898	376	220	122	12	M10x60	83	3,80
95 x 135	70	78	88	17837	376	208	117	12	M10x60	83	5,00
100 x 145	90	100	112	25029	501	211	113	11	M12x80	145	6,00
110 x 155	90	100	112	30039	546	209	115	12	M12x80	145	6,20
120 x 165	90	100	112	38226	637	224	127	14	M12x80	145	7,20
130 x 180	104	116	130	48270	743	201	117	12	M14x90	230	10,00
140 x 190	104	116	130	60654	866	217	129	14	M14x90	230	10,20
150 x 200	104	116	130	69628	928	217	132	15	M14x90	230	10,80
160 x 210	104	116	130	79220	990	217	134	16	M14x90	230	11,50
170 x 225	134	148	164	100851	1186	206	116	14	M16x110	360	17,00
180 x 235	134	148	164	114414	1271	208	119	15	M16x110	360	18,50
190 x 250	134	148	164	128814	1356	210	119	16	M16x110	360	21,50
200 x 260	134	148	164	135594	1356	200	115	16	M16x110	360	22,00
220 x 285	134	148	164	167805	1526	204	118	18	M16x110	360	25,00

CALETTATORI AUTOCENTRANTI "BK 13"

LOCKING ASSEMBLIES SELF-CENTERING "BK 13"

Autocentrante

Momenti torcenti medio elevati

Tolleranze: albero h8 - mozzo H8

Superfici di contatto con rugosità: R_t max 16 μ m

Errore di concentricità: 0,02 mm \div 0,04mm

Tempi di montaggio contenuti

☐ Durante il montaggio si può verificare un leggero spostamento assiale del mozzo rispetto all'albero

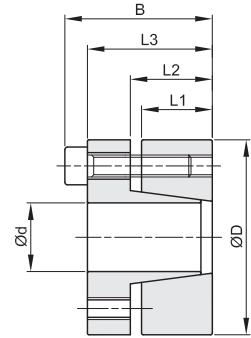
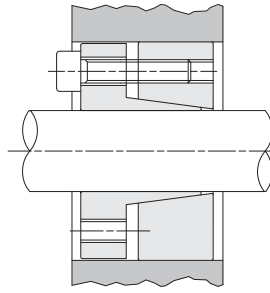

d x D mm	L1 mm	L2 mm	L3 mm	B mm	momento torcente Mt Nm	forza assiale F ass. KN	pressione superficiale		viti di serraggio			Kg.
							albero pw N/mm ²	mozzo pn N/mm ²	DIN 912 12,9 N°	coppia di serraggio Ms Nm		
19 x 47	17	22	28	34	273	29	262	106	5	M6x20	13	0,30
20 x 47	17	22	28	34	287	29	249	106	5	M6x20	13	0,30
22 x 47	17	22	28	34	316	29	227	106	5	M6x20	13	0,30
24 x 50	17	22	28	34	413	34	249	120	6	M6x20	13	0,30
25 x 50	17	22	28	34	431	34	239	120	6	M6x20	13	0,30
28 x 55	17	22	28	34	482	34	213	109	6	M6x20	13	0,40
30 x 55	17	22	28	34	517	34	199	109	6	M6x20	13	0,30
32 x 60	17	22	28	34	734	46	249	133	8	M6x20	13	0,40
35 x 60	17	22	28	34	803	46	227	133	8	M6x20	13	0,40
38 x 65	17	22	28	34	872	46	210	122	8	M6x20	13	0,40
40 x 65	17	22	28	34	918	46	199	122	8	M6x20	13	0,40
42 x 75	20	25	33	41	1563	74	261	146	7	M8x25	32	0,80
45 x 75	20	25	33	41	1674	74	244	146	7	M8x25	32	0,60
50 x 80	20	25	33	41	1860	74	219	137	7	M8x25	32	0,80
55 x 85	20	25	33	41	2340	85	228	148	8	M8x25	32	0,80
60 x 90	20	25	33	41	2553	85	209	139	8	M8x25	32	0,80
65 x 95	20	25	33	41	3110	96	217	149	9	M8x25	32	0,90
70 x 110	24	30	40	50	4838	138	243	154	8	M10x30	65	1,80
75 x 115	24	30	40	50	5184	138	226	148	8	M10x30	65	1,80
80 x 120	24	30	40	50	5530	138	212	142	8	M10x30	65	1,80
85 x 125	24	30	40	50	6610	156	225	153	9	M10x30	65	2,00
90 x 130	24	30	40	50	6998	156	212	147	9	M10x30	65	2,10
95 x 135	24	30	40	50	8208	173	223	157	10	M10x30	65	2,10
100 x 145	26	32	44	56	9742	195	221	152	8	M12x35	110	2,80
110 x 155	26	32	44	56	10716	195	201	143	8	M12x35	110	3,00
120 x 165	26	32	44	56	13154	219	207	151	9	M12x35	110	3,20
130 x 180	34	40	52	64	18996	292	195	141	12	M12x35	110	4,80
140 x 190	34	40	54	68	20336	291	180	133	9	M14x40	170	5,20
150 x 200	34	40	54	68	24211	323	187	140	10	M14x40	170	5,40
160 x 210	34	40	54	68	28408	355	192	147	11	M14x40	170	5,70
170 x 225	44	50	64	78	32929	387	153	115	12	M14x40	170	8,00
180 x 235	44	50	64	78	34866	387	144	110	12	M14x40	170	8,30

CALETTATORI AUTOCENTRANTI "BK 15"

LOCKING ASSEMBLIES SELF-CENTERING "BK 15"

Autocentrante

Momenti torcenti medio elevati
 Tolleranze: albero h8 - mozzo H8
 Superfici di contatto con rugosità: R_t max 16 μ m
 Errore di concentricità: 0,02 mm \div 0,04 mm
 Tempi di montaggio contenuti

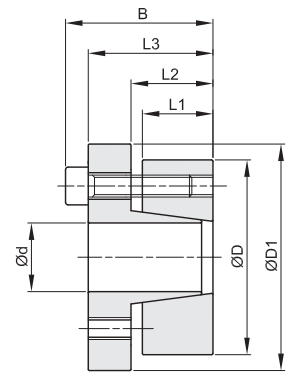
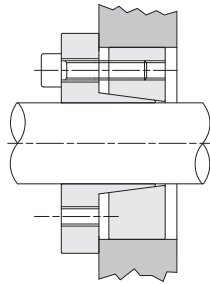

d x D mm	L1 mm	L2 mm	L3 mm	B mm	D1 mm	momento torcente Mt Nm	forza assiale F ass. KN	pressione superficiale		viti di serraggio			
								albero pw N/mm ²	mozzo pn N/mm ²	DIN 912 12,9 N°	coppia di serraggio Ms Nm	Kg.	
14 x 55	17	22	31	39	62	234	33	415	106	4	M8x25	37	0,50
16 x 55	17	22	31	39	62	268	33	363	106	4	M8x25	37	0,50
18 x 55	17	22	31	39	62	333	37	357	117	4	M8x25	41	0,50
19 x 55	17	22	31	39	62	352	37	338	117	4	M8x25	41	0,50
20 x 55	17	22	31	39	62	370	37	321	117	4	M8x25	41	0,50
22 x 55	17	22	31	39	62	407	37	292	117	4	M8x25	41	0,50
24 x 55	17	22	31	39	62	445	37	268	117	4	M8x25	41	0,50
25 x 55	17	22	31	39	62	463	37	257	117	4	M8x25	41	0,50
28 x 55	17	22	31	39	62	519	37	229	117	4	M8x25	41	0,40
30 x 55	17	22	31	39	62	556	37	214	117	4	M8x25	41	0,40
24 x 65	17	22	31	39	72	556	46	335	124	5	M8x25	41	0,70
25 x 65	17	22	31	39	72	579	46	321	124	5	M8x25	41	0,70
28 x 65	17	22	31	39	72	649	46	287	124	5	M8x25	41	0,60
30 x 65	17	22	31	39	72	695	46	268	124	5	M8x25	41	0,60
32 x 65	17	22	31	39	72	741	46	251	124	5	M8x25	41	0,60
35 x 65	17	22	31	39	72	811	46	230	124	5	M8x25	41	0,50
38 x 65	17	22	31	39	72	880	46	211	124	5	M8x25	41	0,50
40 x 65	17	22	31	39	72	927	46	201	124	5	M8x25	41	0,50
30 x 80	20	25	33	41	87	972	65	318	119	7	M8x25	41	1,00
32 x 80	20	25	33	41	87	1037	65	299	119	7	M8x25	41	1,00
35 x 80	20	25	33	41	87	1134	65	273	119	7	M8x25	41	1,00
38 x 80	20	25	33	41	87	1231	65	251	119	7	M8x25	41	1,00
40 x 80	20	25	33	41	87	1296	65	239	119	7	M8x25	41	0,90
42 x 80	20	25	33	41	87	1361	65	227	119	7	M8x25	41	0,90
45 x 80	20	25	33	41	87	1458	65	212	119	7	M8x25	41	0,80
48 x 80	20	25	33	41	87	1555	65	199	119	7	M8x25	41	0,80
50 x 80	20	25	33	41	87	1620	65	191	119	7	M8x25	41	0,80

CALETTATORI AUTOCENTRANTI "BK 16"

LOCKING ASSEMBLIES SELF-CENTERING "BK 16"

Autocentrante

Momenti torcenti medio elevati
 Tolleranze: albero h8 - mozzo H8
 Superfici di contatto con rugosità: R_t max 16 μ m
 Errore di concentricità: 0,02 mm \div 0,04 mm
 Tempi di montaggio contenuti

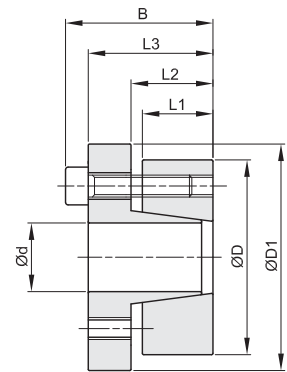
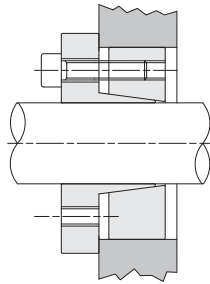

d x D mm	L1 mm	L2 mm	L3 mm	B mm	D1 mm	momento torcente Mt Nm	forza assiale F ass. KN	pressione superficiale		viti di serraggio			
								albero pw N/mm ²	mozzo pn N/mm ²	DIN 912 12,9 N°	coppia di serraggio Ms Nm	tipo	Kg.
19 x 47	17	22	28	34	56	243	26	234	94	5	M6x20	17	0,30
20 x 47	17	22	28	34	56	256	26	222	94	5	M6x20	17	0,30
22 x 47	17	22	28	34	56	282	26	202	94	5	M6x20	17	0,30
24 x 50	17	22	28	34	59	368	31	222	106	6	M6x20	17	0,30
25 x 50	17	22	28	34	59	383	31	213	106	6	M6x20	17	0,30
28 x 55	17	22	28	34	64	429	31	190	97	6	M6x20	17	0,40
30 x 55	17	22	28	34	64	460	31	177	97	6	M6x20	17	0,40
32 x 60	17	22	28	34	69	655	41	222	118	8	M6x20	17	0,40
35 x 60	17	22	28	34	69	716	41	203	118	8	M6x20	17	0,40
38 x 65	17	22	28	34	74	778	41	187	109	8	M6x20	17	0,50
40 x 65	17	22	28	34	74	819	41	178	109	8	M6x20	17	0,50
42 x 75	20	25	33	41	84	1361	65	227	127	7	M8x25	41	0,80
45 x 75	20	25	33	41	84	1458	65	212	127	7	M8x25	41	0,70
50 x 80	20	25	33	41	84	1620	65	191	119	7	M8x25	41	0,80
55 x 85	20	25	33	41	94	2037	74	199	129	8	M8x25	41	0,90
60 x 90	20	25	33	41	99	2223	74	182	121	8	M8x25	41	0,90
65 x 95	20	25	33	41	104	2710	83	189	126	9	M8x25	41	1,00
70 x 110	24	30	40	50	119	4203	120	211	134	8	M10x30	83	1,90
75 x 115	24	30	40	50	124	4754	120	197	128	8	M10x30	83	2,00
80 x 120	24	30	40	50	129	4804	120	184	123	8	M10x30	83	2,00
85 x 125	24	30	40	50	134	5742	135	195	133	9	M10x30	83	2,00
90 x 130	24	30	40	50	139	6080	135	184	128	9	M10x30	83	2,20
95 x 135	24	30	40	50	144	7131	150	194	137	10	M10x30	83	2,30
100 x 145	26	32	44	56	154	8732	175	198	137	8	M12x35	145	3,00
110 x 155	26	32	44	56	164	9605	175	180	128	8	M12x35	145	3,20
120 x 165	26	32	44	56	174	11787	196	186	135	9	M12x35	145	3,40
130 x 180	34	40	52	64	189	17024	262	175	126	12	M12x35	145	5,20
140 x 190	34	40	54	68	199	18703	267	166	122	9	M14x40	230	5,40
150 x 200	34	40	54	68	209	22259	297	172	129	10	M14x40	230	5,70
160 x 210	34	40	54	68	219	26119	326	177	135	11	M14x40	230	6,00
170 x 225	44	50	64	78	234	30276	356	140	106	12	M14x40	230	8,30
180 x 235	44	50	64	78	244	32057	356	133	102	12	M14x40	230	8,80

CALETTATORI AUTOCENTRANTI "BK 19"

LOCKING ASSEMBLIES SELF-CENTERING "BK 19"

Autocentrante

Momenti torcenti medio elevati

Tolleranze: diametro d h8

Tolleranze: diametro dw

da 18 mm a 30 mm compreso H6/j6

da 30 mm a 50 mm compreso H6/h6

da 50 mm a 80 mm compreso H6/g6

da 80 mm a 500 mm compreso H7/g6

Superfici di contatto con rugosità: R_t max 16 μ m

Tempi di montaggio contenuti

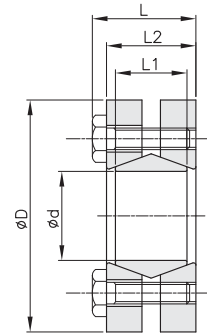
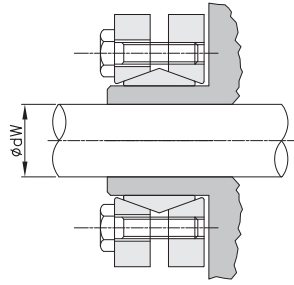

d mm	dw mm	D mm	L1 mm	L2 mm	L mm	pressione superficiale albero pw N/mm ²	momento torcente Mt Nm	forza assiale F ass. KN	viti di serraggio			
									N°	DIN 931 10,9 tipo	coppia di serraggio Ms Nm	Kg.
24	19	50	14	19,5	23	272	162	15,0	6	M5x18	4,9	0,20
	20						200	18,5				
	21						238	21,0				
30	24	60	16	21,5	25	221	285	15,7	7	M5x18	4,9	0,30
	25						323	23,7				
	26						361	26,7				
36	28	72	18	23,5	27,5	292	418	27,0	5	M6x20	11,8	0,40
	30						542	38,0				
	31						599	43,0				
44	32	80	20	25,5	29,5	301	589	44,0	7	M6x20	11,8	0,60
	35						741	49,0				
	36						817	54,0				
50	38	90	22	27,5	31,5	275	893	48,8	8	M6x25	11,8	0,80
	40						1102	58,8				
	42						1311	69,0				
55	42	100	23	30,5	34,5	239	1102	48,0	8	M6x25	11,8	1,10
	45						1444	61,7				
	48						1786	77,0				
62	48	110	23	30,5	34,5	265	1758	69,0	10	M6x25	11,8	1,30
	50						2090	80,9				
	52						2280	90,0				
68	50	115	23	30,5	34,5	242	1900	71,2	10	M6x25	11,8	1,40
	55						2375	80,9				
	60						2993	95,7				
75	55	138	25	32,5	37,8	259	2375	94,4	7	M8x30	29,4	1,70
	60						3040	111,0				
	65						3753	126,0				
80	60	145	25	32,5	37,8	243	3040	99,3	7	M8x30	29,4	1,90
	65						7505	115,0				
	70						4370	130,0				
90	65	155	30	39	44,3	257	4513	141,0	10	M8x35	29,4	3,30
	70						5700	160,0				
	75						6888	178,0				
100	70	170	34	44	49,3	245	6555	163,0	12	M8x35	29,4	4,70
	75						7125	182,0				
	80						8550	202,0				
110	75	185	39	50	56,4	232	6840	185,0	9	M10x40	57,8	5,90
	80						8550	207,0				
	85						10260	221,0				
125	85	215	42	54	60,4	253	10450	240,0	12	M10x40	57,8	8,30
	90						12350	262,0				
	95						14250	285,0				
140	95	230	46	60,5	68	251	14345	308,0	10	M12x45	98	10,00
	100						16720	331,0				
	105						19095	357,0				
155	105	265	50	64,5	72	250	20900	366,0	12	M12x50	98	15,00
	110						23750	392,0				
	115						26600	417,0				
165	115	290	56	71	81	263	29450	513,0	8	M16x55	245	22,00
	120						33250	544,0				
	125						37050	564,0				
175	125	300	56	71	81	248	34200	576,0	8	M16x55	250	22,00
	130						38950	630,0				
	135						45000	666,0				

CALETTATORI NON AUTOCENTRANTI "BK 25"

LOCKING ASSEMBLIES NOT SELF-CENTERING "BK 25"

Non Autocentrante

Momenti torcenti medio bassi
 Tolleranze: albero h8 - mozzo H8
 Superfici di contatto con rugosità: R_t max 16 μ m
 Montaggio e smontaggio rapido

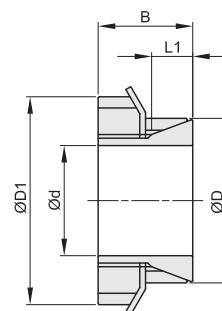
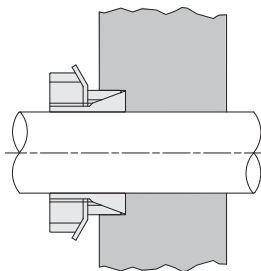

d x D mm	L1 mm	B mm	D1 mm	momento torcente Mt Nm	forza assiale F ass. KN	pressione superficiale		serraggio		Kg.
						albero pw N/mm ²	mozzo pn N/mm ²	ghiera tipo	coppia di serraggio Ms Nm	
17 x 26	6,5	18	38	55	6	197	112	KM5	160	0,07
18 x 26	6,5	18	38	58	6	186	112	KM5	160	0,07
22 x 32	6,5	18	45	96	8	202	127	KM6	220	0,08
28 x 36	7	19,5	52	150	10	176	123	KM7	340	0,15
32 x 42	8	21,5	58	210	12	167	120	KM8	480	0,18
36 x 45	8	21,5	58	240	13	149	120	KM8	480	0,16
38 x 48	10	24,5	65	290	14	126	93	KM9	680	0,28
42 x 55	10	25,5	70	370	17	131	96	KM10	870	0,23
48 x 62	10	25,5	75	500	21	135	105	KM11	970	0,31
50 x 62	10	25,5	75	520	21	130	105	KM11	970	0,32
55 x 68	12	27,5	80	610	22	103	84	KM12	1100	0,38
56 x 68	12	27,5	80	620	22	101	82	KM12	1100	0,39
60 x 73	12	28,5	85	800	27	113	93	KM13	1300	0,43
63 x 79	14	30,5	92	980	31	107	86	KM14	1600	0,47
65 x 79	14	30,5	92	1010	31	104	86	KM14	1600	0,50
70 x 84	14	31,5	98	1240	35	110	92	KM15	2000	0,65

CALETTATORI AUTOCENTRANTI "BK 26"

LOCKING ASSEMBLIES SELF-CENTERING "BK 26"

Autocentrante

Momenti torcenti medio bassi
 Tolleranze: albero h8 - mozzo H8
 Superfici di contatto con rugosità: R_t max 16 μm
 Montaggio e smontaggio rapido

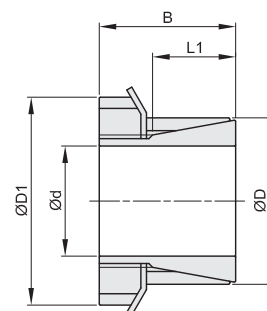
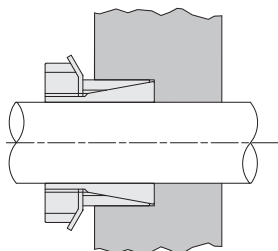

d x D mm	L1 mm	B mm	D1 mm	momento torcente Mt Nm	forza assiale F ass. KN	pressione superficiale		serraggio			
						albero pw N/mm ²	mozzo pn N/mm ²	ghiera N°	tipo	coppia di serraggio Ms Nm	Kg.
15 x 25	20	31	32	77	9	91	55	1	M20x1	95	0,11
18 x 30	21	33	38	125	13	98	59	1	M25x1,5	160	0,13
19 x 30	21	33	38	132	13	93	59	1	M25x1,5	160	0,13
20 x 30	21	33	38	139	13	88	59	1	M25x1,5	160	0,15
24 x 35	25	38	45	202	15	74	51	1	M30x1,5	220	0,17
25 x 35	25	38	45	210	15	71	51	1	M30x1,5	220	0,17
28 x 40	28	44	52	312	20	76	53	1	M35x1,5	340	0,28
30 x 40	28	44	52	335	20	71	53	1	M35x1,5	340	0,26
35 x 45	28	45	58	483	25	75	58	1	M40x1,5	480	0,26
40 x 50	28	46	65	696	31	82	66	1	M45x1,5	680	0,33
45 x 55	28	47	70	902	36	84	69	1	M50x1,5	870	0,45
50 x 60	28	47	75	1014	37	77	64	1	M55x2	970	0,66
55 x 65	28	48	80	1158	38	73	61	1	M60x2	1100	0,72
60 x 70	28	50	85	1379	41	73	62	1	M65x2	1300	0,80

CALETTATORI NON AUTOCENTRANTI "BK 40"

LOCKING ASSEMBLIES NOT SELF-CENTERING "BK 40"

Non Autocentrante

Momenti torcenti medio elevati

Tolleranze: albero h11 - mozzo H11

Superfici di contatto con rugosità: R_t max 16 μ m

Smontaggio rapido

□ Per ottenere una buona concentricità è necessaria una guida tra albero e mozzo

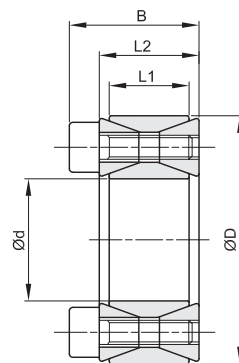
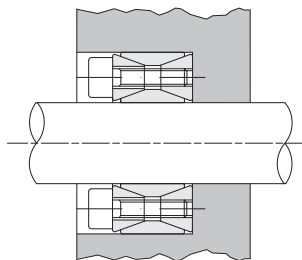

d x D mm	L1 mm	L2 mm	B mm	momento torcente Mt Nm	forza assiale F ass. KN	pressione superficiale		viti di serraggio			
						albero pw N/mm ²	mozzo pn N/mm ²	DIN 912 12,9		coppia di serraggio Ms	
								N°	tipo	Nm	
19 x 47	17	20	26	298	31	286	116	8	M6x18	14,9	0,25
20 x 47	17	20	26	313	31	272	116	8	M6x18	14,9	0,24
22 x 47	17	20	26	345	31	247	116	8	M6x18	14,9	0,23
24 x 50	17	20	26	424	35	255	123	9	M6x18	14,9	0,26
25 x 50	17	20	26	441	35	245	123	9	M6x18	14,9	0,25
28 x 55	17	20	26	549	39	243	124	10	M6x18	14,9	0,30
30 x 55	17	20	26	588	39	227	124	10	M6x18	14,9	0,29
32 x 60	17	20	26	752	47	255	136	12	M6x18	14,9	0,30
35 x 60	17	20	26	822	47	233	136	12	M6x18	14,9	0,32
38 x 65	17	20	26	1042	55	250	146	14	M6x18	14,9	0,36
40 x 65	17	20	26	1097	55	238	146	14	M6x18	14,9	0,34
42 x 75	20	24	32	1740	83	291	163	12	M8x22	35	0,48
45 x 75	20	24	32	1864	83	271	163	12	M8x22	35	0,57
48 x 80	20	24	32	1988	83	254	153	12	M8x22	35	0,59
50 x 80	20	24	32	2071	83	244	153	12	M8x22	35	0,60
55 x 85	20	24	32	2658	97	259	168	14	M8x22	35	0,63
60 x 90	20	24	32	2900	97	238	158	14	M8x22	35	0,69
65 x 95	20	24	32	3587	110	250	171	16	M8x22	35	0,73
70 x 110	24	28	38	5345	153	268	171	14	M10x25	69	1,26
75 x 115	24	28	38	5727	153	250	163	14	M10x25	69	1,33
80 x 120	24	28	38	6108	153	235	156	14	M10x25	69	1,40
85 x 125	24	28	38	7417	175	252	172	16	M10x25	69	1,49
90 x 130	24	28	38	7854	175	238	165	16	M10x25	69	1,53
95 x 135	24	28	38	9326	196	254	179	18	M10x25	69	1,62
100 x 145	26	33	45	11362	227	258	178	14	M12x30	123,3	2,01
110 x 155	26	33	45	12498	227	234	166	14	M12x30	123,3	2,15
120 x 165	26	33	45	15578	260	245	178	16	M12x30	123,3	2,35
130 x 180	34	38	50	21095	325	217	156	20	M12x35	123,3	3,51
140 x 190	34	38	50	24993	357	221	163	22	M12x35	123,3	3,85
150 x 200	34	38	50	29217	390	225	169	24	M12x35	123,3	4,07
160 x 210	34	38	50	33756	422	229	174	26	M12x35	123,3	4,30
170 x 225	38	44	58	39483	465	212	160	22	M14x40	187	5,80
180 x 235	38	44	58	45606	507	218	167	24	M14x40	187	6,00
190 x 250	46	52	66	56163	591	199	152	28	M14x45	187	8,50
200 x 260	46	52	66	63342	633	203	156	30	M14x45	187	8,60
220 x 285	50	56	72	81960	745	200	154	26	M16x50	290	11,00
240 x 305	50	56	72	103162	860	211	166	30	M16x50	290	12,00
260 x 325	50	56	72	126669	974	221	177	34	M16x50	290	13,00
280 x 355	60	66	84	157339	1124	197	156	32	M18x60	400	19,00
300 x 375	60	66	84	189653	1264	207	166	36	M18x60	400	20,00
320 x 405	72	78	98	264108	1651	211	167	36	M20x70	580	30,00

CALETTATORI NON AUTOCENTRANTI "BK 50"

LOCKING ASSEMBLIES NOT SELF-CENTERING "BK 50"

Non Autocentrante

Momenti torcenti medio bassi

Tolleranze:

sino al diametro 40 = albero h6 - mozzo H7

oltre al diametro 40 = albero h8 - mozzo H8

Superfici di contatto con rugosità: R_t max 16 μ m

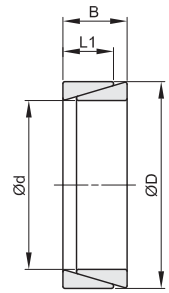
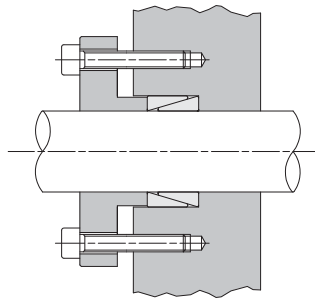

d x D mm	L1 mm	B mm	momento torcente Mt Nm	forza assiale F ass. KN	pressione superficiale		Kg.
					albero pw N/mm ²	mozzo pn N/mm ²	
12 x 15	3,7	4,5	10	2	98	78	0,01
14 x 18	5,3	6,3	19	3	98	76	0,01
15 x 19	5,3	6,3	22	3	98	77	0,01
16 x 20	5,3	6,3	25	3	98	78	0,01
17 x 21	5,3	6,3	28	3	98	79	0,01
18 x 22	5,3	6,3	32	4	98	80	0,01
19 x 24	5,3	6,3	35	4	98	77	0,01
20 x 25	5,3	6,3	39	4	98	78	0,01
22 x 26	5,3	6,3	47	4	98	83	0,01
24 x 28	5,3	6,3	57	5	98	84	0,01
25 x 30	5,3	6,3	61	5	98	81	0,01
28 x 32	5,3	6,3	76	5	98	86	0,01
30 x 35	5,3	6,3	88	6	98	84	0,01
32 x 36	5,3	6,3	100	6	98	87	0,02
35 x 40	6,0	7,0	136	8	98	86	0,02
36 x 42	6,0	7,0	144	8	98	84	0,02
38 x 44	6,0	7,0	160	8	98	84	0,02
40 x 45	6,6	8,0	195	10	98	87	0,03
42 x 48	6,6	8,0	216	10	98	86	0,04
45 x 52	8,6	10,0	321	14	98	85	0,04
48 x 55	8,6	10,0	367	15	98	85	0,05
50 x 57	8,6	10,0	397	16	98	86	0,05
55 x 62	8,6	10,0	480	17	98	87	0,06
56 x 64	10,4	12,0	603	22	98	86	0,07
60 x 68	10,4	12,0	692	23	98	86	0,07
63 x 71	10,4	12,0	764	24	98	87	0,08
65 x 73	10,4	12,0	813	25	98	87	0,08
70 x 79	12,2	14,0	1110	32	98	87	0,11
71 x 80	12,2	14,0	1140	32	98	87	0,12
75 x 84	12,2	14,0	1260	34	98	87	0,12
80 x 91	15,0	17,0	1770	44	98	86	0,20
90 x 101	15,0	17,0	2240	50	98	87	0,22
100 x 114	18,7	21,0	3450	70	98	86	0,38

CALETTATORI AUTOCENTRANTI "BK 61"

LOCKING ASSEMBLIES SELF-CENTERING "BK 61"

Autocentrante

Momenti torcenti medio elevati

Tolleranze: albero h8 - mozzo H8

Superfici di contatto con rugosità: R_t max 16 μ m

Errore di concentricità: 0,02 mm \div 0,04 mm

Tempi di montaggio contenuti

□ Durante il montaggio si può verificare un leggero spostamento assiale del mozzo rispetto all'albero

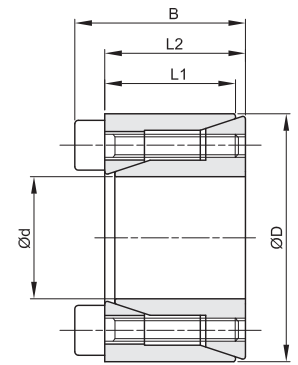
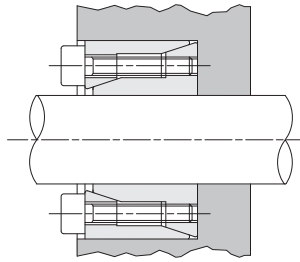

d x D mm	L1 mm	L2 mm	B mm	momento torcente Mt Nm	forza assiale F ass. KN	pressione superficiale		viti di serraggio			Kg.
						albero pw N/mm ²	mozzo pn N/mm ²	DIN 912 12,9 N°	tipo	coppia di serraggio Ms Nm	
10 x 20	12,5	13	15,5	19	3,8	89	45	4	M2,5x12	1,2	0,02
11 x 22	12,5	13	15,5	21	3,8	81	41	4	M2,5x12	1,2	0,02
12 x 22	12,5	13	15,5	23	3,8	75	41	4	M2,5x12	1,2	0,02
14 x 26	16,5	17	20	39	5,5	71	38	4	M3x16	2,1	0,04
15 x 28	16,5	17	20	42	5,5	66	35	4	M3x16	2,1	0,04
16 x 32	16,5	17	21	77	9,6	107	54	4	M4x16	4,9	0,07
17 x 35	20,5	21	25	82	9,6	81	40	4	M4x20	4,9	0,09
18 x 35	20,5	21	25	87	9,6	77	40	4	M4x20	4,9	0,09
19 x 35	20,5	21	25	91	9,6	73	40	4	M4x20	4,9	0,08
20 x 38	20,5	21	26	157	15,7	113	60	4	M5x20	10	0,10
22 x 40	20,5	21	26	173	15,7	103	57	4	M5x20	10	0,11
24 x 47	25	26	32	268	22,3	110	56	4	M6x24	17	0,20
25 x 47	25	26	32	279	22,3	105	56	4	M6x24	17	0,19
28 x 50	25	26	32	468	33,5	141	79	6	M6x24	17	0,22
30 x 55	25	26	32	502	33,5	132	72	6	M6x24	17	0,27
32 x 55	25	26	32	535	33,5	123	72	6	M6x24	17	0,25
35 x 60	30	31	37	781	44,6	125	73	8	M6x28	17	0,36
38 x 65	30	31	37	848	44,6	115	67	8	M6x28	17	0,43
40 x 65	30	31	37	892	44,6	110	67	8	M6x28	17	0,40
42 x 75	35	36	44	1272	60,6	122	68	6	M8x34	41	0,67
45 x 75	35	36	44	1363	60,6	113	68	6	M8x34	41	0,63
48 x 80	35	36	44	1938	80,8	142	85	8	M8x34	41	0,74
50 x 80	35	36	44	2019	80,8	136	85	8	M8x34	41	0,70

CALETTATORI AUTOCENTRANTI "BK 70"

LOCKING ASSEMBLIES SELF-CENTERING "BK 70"

Autocentrante

Momenti torcenti elevati

Tolleranze: albero h8 - mozzo H8

Superfici di contatto con rugosità: R_a max 16 μ m

Errore di concentricità: 0,02 mm \div 0,04mm

Tempi di montaggio contenuti

□ Durante il montaggio si può verificare un leggero spostamento assiale del mozzo rispetto all'albero

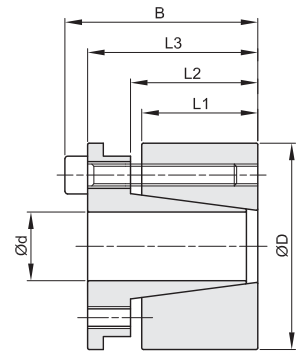
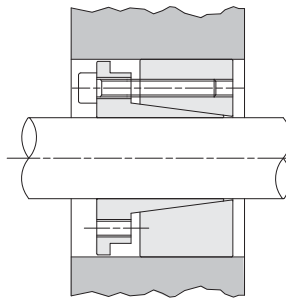

d x D mm	L1 mm	L2 mm	L3 mm	B mm	momento torcente Mt Nm	forza assiale F ass. KN	pressione superficiale		viti di serraggio			
							albero pw N/mm ²	mozzo pn N/mm ²	DIN 912 12,9 N°	coppia di serraggio Ms Nm	Kg.	
19 x 47	26	31	39	45	307	32	193	78	4	M6x25	17	0,39
20 x 47	26	31	39	45	323	32	183	78	4	M6x25	17	0,38
22 x 47	26	31	39	45	355	32	166	78	4	M6x25	17	0,37
24 x 50	26	31	39	45	582	48	229	110	6	M6x25	17	0,43
25 x 50	26	31	39	45	606	48	220	110	6	M6x25	17	0,42
28 x 55	26	31	39	45	679	48	196	100	6	M6x25	17	0,55
30 x 55	26	31	39	45	727	48	183	100	6	M6x25	17	0,56
32 x 60	26	31	39	45	1033	65	229	122	8	M6x25	17	0,60
35 x 60	26	31	39	45	1130	65	209	122	8	M6x25	17	0,50
38 x 65	26	31	39	45	1227	65	193	113	8	M6x25	17	0,60
40 x 65	26	31	39	45	1292	65	183	113	8	M6x25	17	0,60
42 x 75	30	36	47	55	1835	87	204	115	6	M8x30	41	1,00
45 x 75	30	36	47	55	1966	87	191	115	6	M8x30	41	1,00
48 x 80	30	36	47	55	2097	87	179	107	6	M8x30	41	1,10
50 x 80	30	36	47	55	2184	87	172	107	6	M8x30	41	1,00
55 x 85	30	36	47	55	3202	116	208	135	8	M8x30	41	1,10
60 x 90	30	36	47	55	3493	116	191	127	8	M8x30	41	1,20
65 x 95	30	36	47	55	3784	116	176	120	8	M8x30	41	1,30
70 x 110	40	46	57	67	6607	189	199	127	8	M10x35	83	2,20
75 x 115	40	46	62	72	7079	189	186	121	8	M10x35	83	2,50
80 x 120	40	46	62	72	7551	189	174	116	8	M10x35	83	2,60
85 x 125	40	46	62	72	10029	236	205	139	10	M10x35	83	2,80
90 x 130	40	46	62	72	10619	236	193	134	10	M10x35	83	2,70
95 x 135	40	46	62	72	11209	236	183	129	10	M10x35	83	2,90
100 x 145	46	52	77	89	13738	275	176	121	8	M12x45	145	3,90
110 x 155	46	52	77	89	15111	275	160	114	8	M12x45	145	4,20
120 x 165	46	52	77	89	20606	343	183	133	10	M12x45	145	4,80
130 x 180	46	52	77	89	26788	412	203	147	12	M12x45	145	5,00
140 x 190	51	59	84	98	26142	373	154	114	8	M14x45	230	6,50
150 x 200	51	59	84	98	35016	467	180	135	10	M14x45	230	7,00
160 x 210	51	59	84	98	37351	467	169	129	10	M14x45	230	7,00
170 x 225	51	59	84	98	47617	560	191	144	12	M14x45	230	8,50
180 x 235	51	59	84	98	50418	560	180	138	12	M14x45	230	9,00

CALETTATORI AUTOCENTRANTI "BK 71"

LOCKING ASSEMBLIES SELF-CENTERING "BK 71"

Autocentrante

Momenti torcenti elevati
 Tolleranze: albero h8 - mozzo H8
 Superfici di contatto con rugosità: R_t max 16 μ m
 Errore di concentricità: 0,02 mm \div 0,04 mm
 Tempi di montaggio contenuti

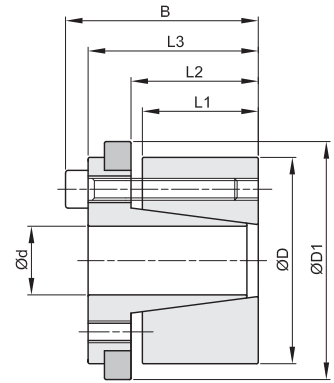
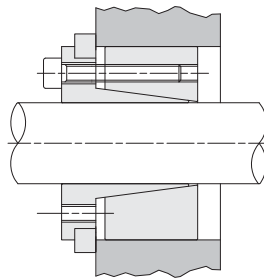

d x D mm	L1 mm	L2 mm	L3 mm	B mm	D1 mm	momento torcente Mt Nm	forza assiale F ass. KN	pressione superficiale		viti di serraggio			
								albero pw N/mm ²	mozzo pn N/mm ²	N°	DIN 912 12,9 tipo	coppia di serraggio Ms Nm	Kg.
19 x 47	26	31	39	45	53	202	21	127	51	4	M6x20	17	0,45
20 x 47	26	31	39	45	53	213	21	121	51	4	M6x20	17	0,46
22 x 47	26	31	39	45	53	234	21	110	51	4	M6x20	17	0,50
24 x 50	26	31	39	45	56	384	32	151	73	6	M6x20	17	0,50
25 x 50	26	31	39	45	56	400	32	145	73	6	M6x20	17	0,50
28 x 55	26	31	39	45	61	448	32	129	66	6	M6x20	17	0,60
30 x 55	26	31	39	45	61	480	32	121	66	6	M6x20	17	0,60
32 x 60	26	31	39	45	66	683	43	151	81	8	M6x20	17	0,70
35 x 60	26	31	39	45	66	747	43	138	81	8	M6x20	17	0,60
38 x 65	26	31	39	45	71	811	43	127	74	8	M6x20	17	0,80
40 x 65	26	31	39	45	71	853	43	121	74	8	M6x20	17	0,60
42 x 75	30	36	47	55	81	1216	58	135	76	6	M8x30	41	1,20
45 x 75	30	36	47	55	81	1302	58	126	76	6	M8x30	41	1,10
48 x 80	30	36	47	55	86	1389	58	119	71	6	M8x30	41	1,30
50 x 80	30	36	47	55	86	1447	58	114	71	6	M8x30	41	1,10
55 x 85	30	36	47	55	91	2124	77	138	89	8	M8x30	41	1,20
60 x 90	30	36	47	55	96	2317	77	127	84	8	M8x30	41	1,30
65 x 95	30	36	47	55	101	2510	77	117	80	8	M8x30	41	1,40
70 x 110	40	46	57	67	116	4381	125	132	84	8	M10x35	83	2,50
75 x 115	40	46	62	72	121	4694	125	123	80	8	M10x35	83	2,60
80 x 120	40	46	62	72	126	5007	125	115	77	8	M10x35	83	2,80
85 x 125	40	46	62	72	131	6651	156	136	92	10	M10x35	83	2,80
90 x 130	40	46	62	72	136	7042	156	128	89	10	M10x35	83	3,00
95 x 135	40	46	62	72	141	7433	156	121	85	10	M10x35	83	3,00
100 x 145	46	52	77	89	151	9104	182	117	81	8	M12x45	145	5,50
110 x 155	46	52	77	89	161	10015	182	106	75	8	M12x45	145	4,80
120 x 165	46	52	77	89	171	13653	228	122	88	10	M12x45	145	5,50
130 x 180	46	52	77	89	186	17747	273	135	97	12	M12x45	145	6,00
140 x 190	51	59	84	98	196	17328	248	102	75	8	M14x45	230	7,50
150 x 200	51	59	84	98	206	23207	309	119	89	10	M14x45	230	7,70
160 x 210	51	59	84	98	216	24754	309	112	85	10	M14x45	230	8,00
170 x 225	51	59	84	98	231	31561	371	126	95	12	M14x45	230	9,80
180 x 235	51	59	84	98	241	33417	371	119	91	12	M14x45	230	9,80

CALETTATORI AUTOCENTRANTI "BK 80"

LOCKING ASSEMBLIES SELF-CENTERING "BK 80"

Autocentrante

Momenti torcenti medio elevati
 Tolleranze: albero h8 - mozzo H8
 Superfici di contatto con rugosità: R_f max 16 μ m
 Errore di concentricità: 0,02 \pm 0,04 mm
 Tempi di montaggio contenuti
 Ingombri radiali ristretti
 Pressioni superficiali contenute

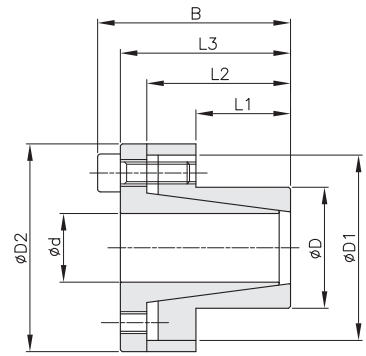
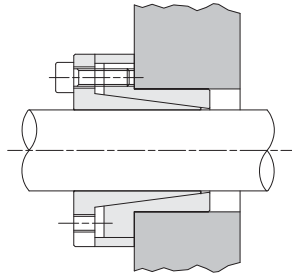

d x D mm	L1 mm	L2 mm	L3 mm	B mm	D1 mm	D2 mm	momento torcente Mt Nm	forza assiale F ass. KN	pressione superficiale		viti di serraggio			
									albero pw N/mm ²	mozzo pn N/mm ²	DIN 912 12,9 N°	coppia di serraggio Ms Nm	Kg.	
8 x 15	12	21	24	28	28	32	39	10	299	159	4	M4x10	5,2	0,16
9 x 16	14	23	27	31	28	32	44	10	227	128	4	M4x12	5,2	0,16
10 x 16	14	23	27	31	28	32	49	10	205	128	4	M4x12	5,2	0,17
11 x 18	14	23	27	31	30	34	53	10	186	114	4	M4x12	5,2	0,17
12 x 18	14	23	27	31	30	34	58	10	171	114	4	M4x12	5,2	0,18
14 x 23	14	23	27	31	35	39	68	10	146	89	4	M4x12	5,2	0,20
15 x 24	16	29	36	42	40	45	120	16	196	123	4	M6x18	17	0,21
16 x 24	16	29	36	42	40	45	128	16	184	123	4	M6x18	17	0,23
18 x 26	18	31	38	44	42	47	191	21	194	134	4	M6x18	17	0,27
19 x 27	18	31	38	44	43	48	202	21	183	129	4	M6x18	17	0,29
20 x 28	18	31	38	44	44	49	213	21	174	124	4	M6x18	17	0,30
22 x 32	25	38	45	51	48	54	234	21	114	78	4	M6x18	17	0,38
24 x 34	25	38	45	51	50	56	255	21	105	74	4	M6x18	17	0,41
25 x 34	25	38	45	51	50	56	266	21	100	74	4	M6x18	17	0,45
28 x 39	25	38	45	51	55	61	373	27	112	81	5	M6x18	17	0,47
30 x 41	25	38	45	51	57	63	480	32	126	92	6	M6x18	17	0,48
32 x 43	30	43	50	56	59	65	511	32	98	73	6	M6x18	17	0,51
35 x 47	30	43	50	56	63	69	747	43	120	89	8	M6x18	17	0,63
38 x 50	30	43	50	56	66	72	811	43	110	84	8	M6x18	17	0,67
40 x 53	32	45	52	58	69	75	959	48	110	83	9	M6x18	17	0,73
42 x 55	32	45	52	58	71	77	1007	48	105	80	9	M6x18	17	0,78
45 x 59	40	56	64	72	79	85	1781	79	130	99	8	M8x22	42	1,23
48 x 62	40	56	64	72	82	88	1900	79	122	94	8	M8x22	42	1,24
50 x 65	50	66	74	82	85	92	2473	99	117	90	10	M8x22	42	1,40
55 x 71	50	66	74	82	91	98	2721	99	106	82	10	M8x22	42	1,70
60 x 77	50	66	74	82	97	104	2968	99	97	76	10	M8x22	42	1,76
65 x 84	50	66	74	82	104	111	3215	99	90	69	10	M8x22	42	2,21
70 x 90	60	80	91	101	115	122	4430	127	89	69	8	M10x25	84	3,05
75 x 95	60	80	91	101	119	126	5338	142	93	74	9	M10x25	84	3,32
80 x 100	65	85	96	106	124	131	7595	190	108	86	12	M10x25	84	3,50
85 x 106	65	85	96	106	130	137	8069	190	101	81	12	M10x25	84	3,60
90 x 112	65	85	96	106	136	143	9968	222	112	90	14	M10x25	84	3,90
95 x 120	65	85	96	106	144	153	10522	222	106	84	14	M10x25	84	4,40
100 x 125	65	89	102	114	153	162	13651	273	124	99	12	M12x30	145	4,60
110 x 140	70	94	107	119	168	177	15016	273	105	82	12	M12x30	145	8,70
120 x 155	90	114	127	139	185	195	21844	364	99	77	16	M12x30	145	10,70
130 x 165	90	114	127	139	195	205	23664	364	92	72	16	M12x30	145	11,30
140 x 175	90	114	127	139	205	215	25485	364	85	68	16	M12x30	145	11,90
150 x 185	90	114	127	139	215	225	27305	364	80	64	16	M12x30	145	12,50

CALETTATORI - GIUNTO RIGIDO "BK 95"

LOCKING ASSEMBLIES - RIGID COUPLING "BK 95"

Momenti torcenti medio elevati
 Tolleranze: albero h8
 Superficie di contatto con rugosità: R_t max 16 μ m
 Montaggio e smontaggio rapido
 Adatto per il collegamento rigido
 fra due alberi allineati

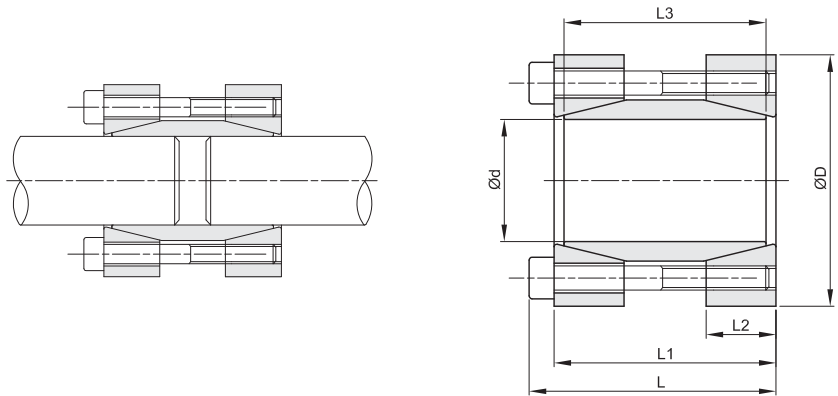

d x D mm	L mm	L1 mm	L2 mm	L3 mm	momento torcente Mt Nm	forza assiale F ass. KN	pressione superficiale albero pw N/mm ²	viti di serraggio			
								DIN 912 12,9 Ms	tipo	coppia di serraggio Nm	Kg.
17 x 50	56	50	16	44	179	21	166	4	M6x45	17	0,51
18 x 50	56	50	16	44	190	21	157	4	M6x45	17	0,52
19 x 50	56	50	16	44	200	21	149	4	M6x45	17	0,50
20 x 50	56	50	16	44	211	21	141	4	M6x45	17	0,50
24 x 55	66	60	18,5	54	378	32	144	6	M6x55	17	0,71
25 x 55	66	60	18,5	54	394	32	138	6	M6x55	17	0,69
28 x 60	66	60	18,5	54	442	32	123	6	M6x55	17	0,81
30 x 60	66	60	18,5	54	473	32	115	6	M6x55	17	0,78
32 x 63	66	60	18,5	54	505	32	108	6	M6x55	17	0,85
35 x 75	83	75	22	67	682	39	98	4	M8x70	42	1,48
38 x 75	83	75	22	67	741	39	90	4	M8x70	42	1,45
40 x 75	83	75	22	67	780	39	86	4	M8x70	42	1,40
42 x 78	83	75	22	67	819	39	82	4	M8x70	42	1,50
45 x 85	93	85	24,5	76	1317	59	101	6	M8x80	42	2,03
48 x 90	93	85	24,5	76	1405	59	95	6	M8x80	42	2,24
50 x 90	93	85	24,5	76	1463	59	91	6	M8x80	42	2,18
55 x 94	93	85	24,5	76	2147	78	110	8	M8x80	42	2,29
60 x 100	93	85	24,5	76	2343	78	101	8	M8x80	42	2,52
65 x 105	93	85	24,5	76	2538	78	93	8	M8x80	42	2,69
70 x 115	110	100	29	90	4321	123	116	8	M10x95	83	3,94

SLITTE TENDICINGHIA PER MOTORI ELETTRICI ADJUSTABLE MOTOR MOUNTING

Descrizione - Description

Le slitte porta motore risolvono il problema della tensione delle cinghie nelle trasmissioni di potenza.

Sono di facile montaggio e permettono la regolazione di tensionamento o lo smontaggio delle cinghie senza dover rimuovere il motore elettrico. Il movimento della slitta è comandato da una vite che si regola con una comune chiave.

The adjustable motor mountings solve the problem of the belt tension in the power transmission.

They are easy to assemble and allow adjustment of belt tension or disassembly without removing the electric motor. The movement of the motor is controlled by a screw which is adjusted by a common key.

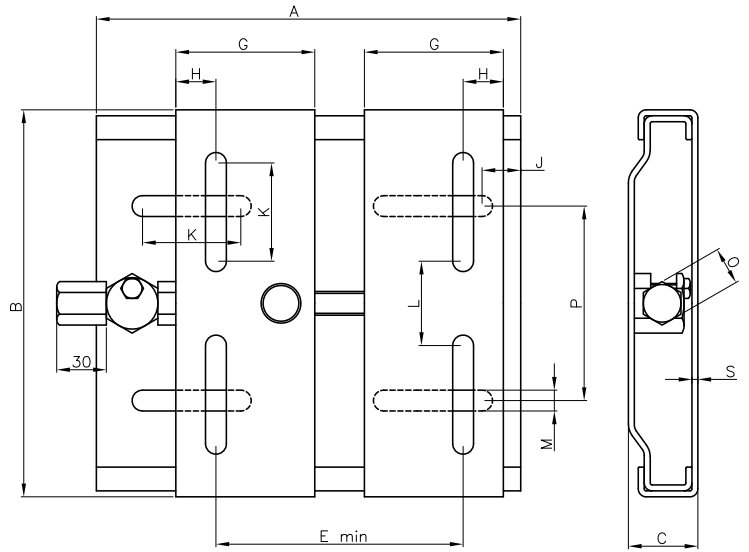

Materiale - Material

Le slitte tendicinghia sono in lamiera di acciaio zincato, trattamento che protegge dall'ossidazione e dalla corrosione.

The adjustable motor mountings are in zinc plated steel, treatment that protects against oxidation and corrosion.

tipo	A	B	C	E min	L	G	H	J	K	M	O	P	S	Kg
210	210	195	33	100	43	70	20	25	50	10,5	19	98	3	2,20
270	270	195	33	100	43	70	20	25	50	10,5	19	98	3	2,70
307	307	213	33	100	65	70	20	25	50	10,5	19	108	3	3,30
340	340	290	40	140	90	95	27	30	62,5	12,5	22	165	4	6,30
430	430	290	40	140	90	95	27	30	62,5	12,5	22	165	4	7,40
490	490	410	40	254	193	95	40	30	60	15,0	22	284	4	10,80

tipo	Motori	63	71	80	90	100	112	132	160	180
210	CORSA DI REGOLAZIONE mm	70	58	45						
270		130	118	105	90	70	40			
307					127	107	77			
340					140	130	100	75		
430						216	186	160	122	
490									156	131

GIUNTI DENTATI - "GFB" GEAR COUPLINGS - "GFB"

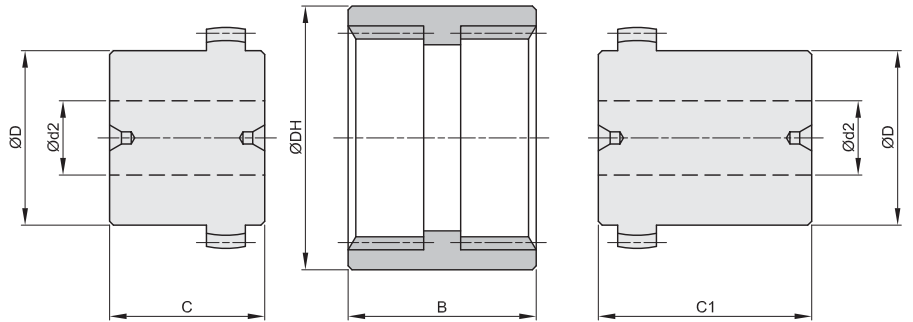

codice	foro	foro	manicotto			mozzo standard			mozzo lungo		
	Ød1	MAX	ØDH	B	peso	ØD	C	peso	ØD	C1	peso
	mm	Ød2	mm	mm	Kg	mm	mm	Kg	mm	mm	Kg
GFB-14	-	15	40	37	0,02	24	23	0,09	24	40	0,15
GFB-19	-	20	48	37	0,03	30	25	0,15	30	40	0,23
GFB-24	-	24	52	41	0,04	36	26	0,22	36	50	0,40
GFB-28	-	28	66	46	0,07	44	40	0,50	44	55	0,69
GFB-32	-	32	76	48	0,09	50	40	0,67	50	55	0,90
GFB-38	-	38	83	48	0,11	58	40	0,80	58	60	1,30
GFB-42	-	42	92	50	0,14	65	42	1,17	65	60	1,60
GFB-48	-	48	95	50	0,16	67	50	1,43	67	60	1,70
GFB-65	23	65	132	68	0,37	96	55	3,20	96	70	4,05

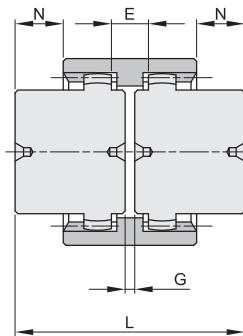

GFB-SS

2 mozzi standard

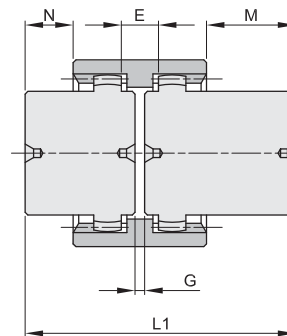

GFB-SL

1 mozzo standard
1 mozzo lungo

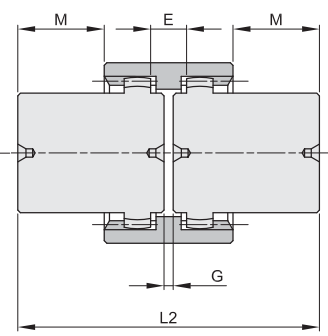

GFB-LL

2 mozzi lunghi

codice	GFB-SS				GFB-SL		GFB-LL			
	G	E	M	N	L	peso	L1	peso	L2	peso
	mm	mm	mm	mm	mm	Kg	mm	Kg	mm	Kg
GFB-14	4	15	23,5	6,5	50	0,20	67	0,26	84	0,32
GFB-19	4	20	23,5	8,5	54	0,33	69	0,41	84	0,49
GFB-24	4	24	31,5	7,5	56	0,48	80	0,66	104	0,84
GFB-28	4	28	34	19	84	1,07	99	1,26	114	1,45
GFB-32	4	32	33	18	84	1,43	99	1,66	114	1,89
GFB-38	4	38	38	18	84	1,71	104	2,21	124	2,71
GFB-42	4	42	37	19	88	2,48	106	2,91	124	3,34
GFB-48	4	48	37	27	104	3,02	114	3,29	124	3,56
GFB-65	4	65	38	23	114	6,77	129	7,62	144	8,47

GIUNTI DENTATI - "GFB" GEAR COUPLINGS - "GFB"

Descrizione e caratteristiche

- Costituiti da due mozzi in acciaio ed un manicotto in resina poliammide dentato internamente;
- Permettono un'ottima compensazione negli spostamenti assiali, radiali ed angolari nel collegamento degli alberi;
- I giunti con dentatura bombata e l'accoppiamento acciaio-resina non richiedono alcuna manutenzione;
- Di facile montaggio sia in orizzontale che in verticale;
- Temperatura di impiego da -25° a +100°



Characteristics

- Consist in two curved toothed hubs made in steel and one internally toothed sleeve made in polyamide;
- Able to compensate for axial, radial and angular misalignments of the connected shafts;
- Steel and polyamide combination makes maintenance-free;
- Easy to be mounted both in vertical and horizontal planes;
- Suitable for temperatures from -25° to +100°

codice	coppia		fattore di potenza		potenza trasmissibile (KW giri/1')										J* Kg cm ²
	Nm		$\frac{P}{n}$		750		1000		1500		3000		giri/1'		
	norm.	max	norm.	max	norm.	max	norm.	max	norm.	max	norm.	max	max		
GFB-14	10	20	0,0010	0,0021	0,79	1,57	1,05	2,09	1,57	3,14	3,14	6,28	14000	0,3	
GFB-19	16	32	0,0017	0,0034	1,26	2,51	1,68	3,35	2,51	5,03	5,03	10,05	11800	0,5	
GFB-24	20	40	0,0021	0,0042	1,57	3,14	2,09	4,19	3,14	6,28	6,28	12,57	10600	1,0	
GFB-28	45	90	0,0047	0,0094	3,53	7,07	4,71	9,42	7,07	14,14	14,14	28,27	8500	3,1	
GFB-32	60	120	0,0063	0,0126	4,71	9,42	6,28	12,57	9,42	18,85	18,85	37,70	7500	5,5	
GFB-38	80	160	0,0084	0,0168	6,28	12,57	8,38	16,75	12,57	25,13	25,13	50,26	6700	8,7	
GFB-42	100	200	0,0105	0,0209	7,85	15,71	10,47	20,94	15,71	31,41	31,41	62,83	6000	14,3	
GFB-48	140	280	0,0147	0,0293	10,99	21,99	14,66	29,32	21,99	43,98	43,98	87,96	5600	18,4	
GFB-65	380	760	0,0398	0,0796	29,84	59,69	39,79	79,58	59,69	119,37	119,37	238,74	4000	109,0	

* Momento d'inerzia riferito al giunto
con mozzo standard con foro MAX (ød2)

codice	disassamento massimo per ogni mozzo		spostamento assiale (mm)
	ka (Δ)	kr(mm)	
GFB-14	± 2°	± 0,3	± 1
GFB-19	± 2°	± 0,4	± 1
GFB-24	± 2°	± 0,4	± 1
GFB-28	± 2°	± 0,5	± 1
GFB-32	± 2°	± 0,5	± 1
GFB-38	± 2°	± 0,5	± 1
GFB-42	± 2°	± 0,5	± 1
GFB-48	± 2°	± 0,5	± 1
GFB-65	± 2°	± 0,6	± 1

Norme di montaggio

- 1) Fissare i due mozzi agli alberi da accoppiare. La facciata interna del mozzo deve risultare a filo dell'estremità del rispettivo albero;
- 2) Infilare il manicotto sui due mozzi e regolare la distanza dei giunti come da quota "G";
- 3) Fissare in questa posizione i due alberi da accoppiare;
- 4) Accertarsi che il manicotto sia libero di spostarsi assialmente.

Mounting instructions

- 1) Fix the two hubs to the shafts. The inner sides of the hubs must be aligned with the shaft ends;
- 2) Insert the sleeve on the two hubs and adjust the distance of elements as per size "G";
- 3) Fix to this position the two elements to be coupled;
- 4) The sleeve must be free to move axially.

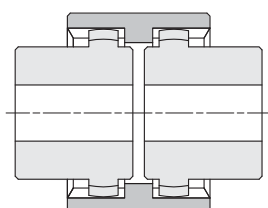

allineati

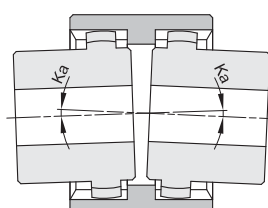

disassamento
angolare

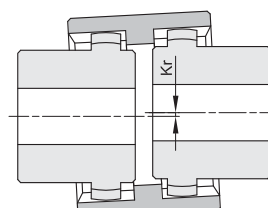

disassamento
radiale

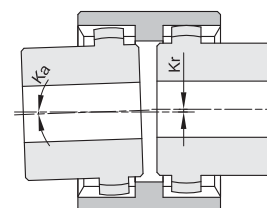

disassamento
radiale/angolare

CONDIZIONI GENERALI DI VENDITA

1) ORDINI - Gli ordini per materiali standard e speciale devono essere sempre riferiti alle offerte della BEA INGRANAGGI S.p.A. Le ordinazioni sono impegnative per il cliente. Una volta iniziata la lavorazione non si accettano annullamenti o riduzioni dell'ordine salvo il risarcimento da parte del cliente dei costi di materiale e di lavorazione sostenuti fino al momento della sospensione. La quantità spedita può variare del \pm 5% rispetto alla quantità ordinata.

2) PREZZI - Si intendono quelli in vigore alla data dell'ordine. Tutti i prezzi sono per merce resa franco Premezzo, imballo escluso. Qualora nel corso della fornitura si verificassero aumenti nel materiale o negli altri costi di produzione è facoltà della BEA INGRANAGGI S.p.A. di adeguare i prezzi, anche per gli ordini in corso, agli aumenti verificatisi.

3) TERMINI DI CONSEGNA - Sono da considerarsi validi solo i termini di consegna indicati dalla BEA INGRANAGGI S.p.A. Essi sono da considerarsi comunque solo indicativi. Nei casi di difficoltà nell'approvvigionamento dei materiali, di sciopero o comunque in tutti i casi di forza maggiore, i termini di consegna vengono automaticamente prorogati senza che la BEA INGRANAGGI S.p.A. sia tenuta a corrispondere indennizzi di sorta. Il cliente ha in ogni caso l'obbligo del ritiro del materiale speciale ordinato all'aprontamento.

4) SPEDIZIONI - Le spedizioni si intendono a carico del committente ed eseguite a suo rischio e pericolo anche quelle franco di porto. I reclami per eventuali ammanchi devono presentarsi entro 8 gg. dal ricevimento della merce. Qualora venga pattuito che il costo del trasporto sia a carico, anche solo in parte, della BEA INGRANAGGI S.p.A., questa si riserva il diritto di scegliere il mezzo di spedizione più economico.

5) L'imballo è fatturato al prezzo di costo.

6) GARANZIA - La ditta BEA INGRANAGGI S.p.A. si impegna a riparare o sostituire gratuitamente quei pezzi da essa riconosciuti difettosi. La merce contestata dev'essere resa alla sede della BEA INGRANAGGI S.p.A. franco di ogni spesa. La garanzia decade qualora i pezzi resi come difettosi siano stati riparati o manomessi. Le riparazioni di pezzi difettosi eseguite dal committente saranno riconosciute solamente dietro autorizzazione della BEA INGRANAGGI S.p.A. e dopo approvazione di essa al preventivo di spesa. La BEA INGRANAGGI S.p.A. non assume responsabilità nè riconosce indennizzi di sorta per i danni che si verificassero durante l'impiego dei suoi prodotti anche se difettosi.

7) PAGAMENTI - Saranno riconosciuti validi solo i pagamenti effettuati nei modi e nei termini pattuiti. Trascorso il termine di pagamento la BEA INGRANAGGI S.p.A. conteggerà gli interessi di mora al tasso del 3% superiore a quello legale, fermo il diritto di esigere il pagamento. In caso di ritardato o mancato pagamento da parte del committente la ditta BEA INGRANAGGI S.p.A. si riserva il diritto di sospendere le consegne degli ordini in corso o di pretendere il pagamento anticipato senza riconoscere al committente indennizzi di sorta o risarcimenti.

Qualsiasi contestazione dei materiali in corso di fabbricazione o già in possesso del committente non libera quest'ultimo dall'effettuare il pagamento alla scadenza stabilita e per l'intero ammontare della fattura senza alcuna detrazione.

8) PROPRIETÀ - Tutta la merce spedita rimane sempre di proprietà della Ditta BEA INGRANAGGI S.p.A. fino al pagamento completo delle sue fatture.

9) FORO COMPETENTE - Qualsiasi controversia inerente ai rapporti commerciali con la BEA INGRANAGGI S.p.A. sarà di competenza del Tribunale di Busto Arsizio.

GENERAL TERMS OF SALE

1) ORDERS - Orders for standard and special materials or to drawing must always refer to messrs BEA's offer. Orders are compelling for client and from starting of production, cancellation or reductions, even if partial, won't be accepted, excepting indemnity of manufacturing and material costs met up to cancellation. We reserve the right to supply plus/minus 5% of the quantity ordered.

2) PRICES - Prices are the effective ones at order-date. All prices have to be understood Ex-factory, excluding packing. Should increases in manufacturing costs, materials and so on, take place between the date of our order-confirmation and completion of order, our prices will be amended accordingly without prior notice being given.

3) DELIVERY TERMS - Only the deliverytime stated by Messrs BEA INGRANAGGI S.p.A. must be considered valid. The quoted terms of delivery are without engagement, i.e. not legally binding. Indemnification claims for non-fulfilment of/or belated deliveries are not accepted. The purchaser is not entitled to refuse part deliveries. The purchaser is forced to accept the deliveries to our normal working. Unforeseen events such as force majeure, breakdown, transportation delays, difficulties in supply of raw material, strikes, lockouts in our or in the plants of our suppliers, likewise wastage involving extra production, entitle us to postpone delivery for the period of the handicap and an appropriate new start or to cancel the uncompleted part.

4) DESPATCHES - The despatch of goods, including freight free deliveries is effected to the best judgement but without obligation, and at sole risk of the purchaser. Claims for eventual shortage must be produced within eight (8) days from receipt of goods. If transport freight, even if partially, are paved by Messrs BEA INGRANAGGI S.p.A. they reserve the right to choose the means of conveyance.

5) PACKING - Packing cases are charged at cost.

6) WARRANTY - Messrs BEA INGRANAGGI S.p.A. engage themselves to repair or replace, free of charge, pcs they recognize faulty. Said goods have to be returned free our warehouse, packing and customs included. Warranty decay when pcs returned as wanting, have been repaired or with. Reworking of defective pcs made by the buyer will be recognized only if entitled by Messrs BEA INGRANAGGI S.p.A. after their approval of estimate Messrs BEA INGRANAGGI S.p.A. do not take responsibility upon eventual damages involved in the use of their products, even if defective.

7) PAYMENTS - Will be considered valid on only the payments effected according to terms agreed. When exceeding our payment terms, interest at 3% above the bank interest we have to pay is imposed without formal notice of detention. Non-observance of the payment terms, or circumstances becoming known to us after the conclusion of the contract which are apt to diminish the credit worthiness of the buyer, immediately cause all debts to have matured. In addition, this entitles us to make further deliveries only against payment in advance, or to retire from the contract and claim compensation for non-fulfilment thereof. Withholding or compensation offset is not accepted.

8) PROPERTY -All the goods delivered remain always of property of Messrs. BEA INGRANAGGI S.p.A. up to the time of complete payment of the invoices.

9) COURT OF JUSTICE - In the event of debate the Court of Busto Arsizio (Va) have exclusive jurisdiction for purchaser and seller.

ALLEGEMEINE VERKAUFSBEDINGUNGEN

1) BESTELLUNGEN - Die Bestellungen für Standard- oder Spezial-Ausführung müssen sich auf Offerten der BEA INGRANAGGI S.p.A. beziehen. Die Bestellungen sind für den Kunden verbindlich. Wenn die Arbeit begonnen hat, werden Annullationen oder Reduzierungen nicht mehr angenommen, ausser, dass der Kunde die Kosten für Material und Arbeit bis zur Aufhebung des Auftrages bezahlt. Die Toleranz der gelieferten Ware kann gegenüber der bestellten Menge +/-5% betragen.

2) PREISE - Es gelten diejenigen Preise, die am Tage der Bestellung gültig sind. Die Preise verstehen sich ab Werk Premezzo, ohne Verpackung. Falls während der Lieferzeit sich berechnete Preiserhöhungen für Material und Arbeitskosten einstellen, hat die BEA INGRANAGGI S.p.A. das Recht, die Preise entsprechend anzugleichen, auch für laufende Bestellungen.

3) LIEFERFRIST - Nur die von der BEA INGRANAGGI S.p.A. bestätigten Liefertermine sind gültig, aber nur unverbindlich. Im Falle von Schwierigkeiten in der Materialbeschaffung, Streiks oder andere Fälle von höherer Macht, werden die Liefertermine automatisch verlängert, ohne dass die BEA INGRANAGGI S.p.A. für Schadenansprüche irgendwelcher Art beiangt werden kann. Der Kunde ist in jedem Fall verpflichtet, bei Fertigstellung von Spezialanfertigungen die Ware zu beziehen.

4) SPEDITIONEN - Die Speditionen verstehen sich zu Lasten des Auftraggebers und ausgeführt auf dessen Risiko und Gefahr, auch diejenigen franko Haus. Reklamationen wegen eventuellen Manki müssen innert 8 Tagen nach Erhalt der Sendung gemeldet werden. Wenn vereinbart wird, dass die Transportkosten zu Lasten von BEA INGRANAGGI S.p.A. gehen, auch nur teilweise, so kann diese den günstigsten Speditionsweg wählen.

5) VERPACKUNG - Die Verpackung wird zu Selbstkosten verrechnet.

6) GARANTIE - Die Firma BEA INGRANAGGI S.p.A. verpflichtet sich gratis jene Stücke zu reparieren oder zu ersetzen, welche von ihr als defekte anerkannt werden. Die beanstandete Ware muss frei von allen Spesen der BEA INGRANAGGI S.p.A. zugestellt werden. Die Garantie verfällt, wenn die als defekt retournierten Stücke vom Kunden repariert oder bearbeitet worden sind. Die vom Kunden durchgeführten Reparaturen von defekten Stücken werden von der BEA INGRANAGGI S.p.A. erst nach Prüfung der mitgeteilten Spesen anerkannt. Die BEA INGRANAGGI S.p.A. übernimmt keine Verantwortung, noch anerkennt sie Schäden jeglicher Art, die sich während dem Gebrauch seiner Artikel ergeben, auch wenn diese defekt sind.

7) ZAHLUNGEN - Es werden Zahlungen anerkannt, welche zum vereinbarten Termin erfolgen. Wenn der Zahlungstermin abgelaufen ist, berechnet die BEA INGRANAGGI S.p.A. Verzugszinsen von 3% über dem normalen Zins, behält sich das Recht vor die Zahlung zu veranlassen. Bei verspäteter oder Nichtzahlung des Kunden, behält sich die BEA INGRANAGGI S.p.A. das Recht vor, Lieferungen von laufenden Aufträgen einzustellen oder Vorauszahlung zu verlangen, ohne Schadenansprüche oder Entschädigungen aller Art zu gewähren. Jede Anfechtung der Materialien in Fabrikation oder schon im Besitze des Kunden, befreit diesen nicht zur Zahlung auf den festgesetzten Termin und zwar für die ganze Summe der Faktura, ohne jeglichen Abzug.

8) EINGENTUMSVORBEHALT - Alle gelieferten Waren bleiben Eigentum der BEA INGRANAGGI S.p.A. bis zur vollständigen Bezahlung der Fakturen

9) GERICHTSSTAND UND ERFÜLLUNGORT - Bei allen sich aus den Geschäftsbeziehungen ergebenden Streitigkeiten ist das Gericht von BUSTO ARSIZIO zuständig.

CONDITIONS GENERALES DE VENTE

1) COMMANDES - Les commandes pour du matériel standard ou spécial se réfèrent toujours aux offres de Prix de la BEA INGRANAGGI S.p.A. Les commandes sont fermes et définitives. Une fois que l'usinage des articles est commencé nous n'acceptons plus les annulations ni les réductions de commande à moins que le client nous règle les coûts des matériaux et de l'usinage réalisé au moment de la suspension. La quantité expédiée peut varier de $\pm 5\%$ par rapport à la quantité commandée.

2) PRIX - Ils sont ceux en vigueur à la date de la commande. Tous les prix s'entendent pour marchandise départ PREMEZZO. Emballage exclu. Si pendant la livraison il se vérifie des augmentations de matière première où dans les autres coûts de production la BEA INGRANAGGI S.p.A. aura la faculté d'adapter ses prix, même pour les commandes en cours.

3) DELAIS DE LIVRAISON - Sont seules valables les délais de livraison confirmés par la BEA INGRANAGGI S.p.A. Ils s'entendent toutefois indicatifs. En cas de force majeure (difficulté d'approvisionnement les matériaux, grèves etc.), les délais seront automatiquement prorogés sans que la BEA INGRANAGGI S.p.A. soit tenue de verser des intérêts ou de pénalités de toute sorte.

4) EXPEDITIONS - Les expéditions sont à la charge du client à ses risques et périls même en envoi Franco de Port. Les réclamations pour des manques éventuels doivent parvenir 8 jours francs à réception de marchandise. Au cas où la BEA INGRANAGGI S.p.A. prend en charge, même partiellement le coût du transport, elle se réserve le droit de choisir le moyen du transport le plus économique.

5) EMBALLAGE - Il est facturé au coût. Nous n'acceptons pas de retour.

6) GARANTIE - La BEA INGRANAGGI S.p.A. s'engage à réparer ou substituer gratuitement les pièces reconnues defectueuses. La marchandise contestée doit être rendue au siège Franco de toute dépense. La garantie n'est pas applicable si les pièces ont été retouchées. Leur réparation est acceptée uniquement si une autorisation est accordée par la BEA INGRANAGGI S.p.A. La garantie ne couvre pas l'usage qui est fait de nos produits.

7) PAIEMENTS - Ne seront reconnus valables que les règlements effectués dans les modes et termes accordés. En cas de délais de règlement dépassés la BEA INGRANAGGI S.p.A. comptera les intérêts de retard au taux de 3% supérieur à celui légal. De même elle suspendra les livraisons des commandes en cours et prendra le règlement anticipé sans reconnaître au client aucune indemnité.

Aucun prétexte que ce soit même litigieux ne peut retarder ou modifier les termes de paiement.

8) PROPRIÉTÉ - Toute marchandise expédiée reste la propriété de la BEA INGRANAGGI S.p.A. jusqu'à son paiement complet.

9) JURIDICTION - En cas de contestations seules seront compétentes les juridictions de notre Siège Social. Le Tribunal compétent est celui de BUSTO ARSIZIO (I).